

# Eikonal Approximation in AdS/CFT: Resumming the Gravitational Loop Expansion

Lorenzo Cornalba<sup>a</sup>, Miguel S. Costa<sup>b,c</sup>, João Penedones<sup>b</sup>

<sup>a</sup>Dipartimento di Fisica & INFN, Università di Roma “Tor Vergata”,  
Via della Ricerca Scientifica 1, 00133, Roma, Italy

<sup>b</sup>Departamento de Física e Centro de Física do Porto,  
Faculdade de Ciências da Universidade do Porto,  
Rua do Campo Alegre, 687, 4169-007 Porto, Portugal

<sup>c</sup>Laboratoire de Physique Théorique de l’Ecole Normale Supérieure,  
24 Rue Lhomond, 75231 Paris, France

cornalba@roma2.infn.it, miguelc@fc.up.pt, jpenedones@fc.up.pt

## Abstract

We derive an eikonal approximation to high energy interactions in Anti-de Sitter spacetime, by generalizing a position space derivation of the eikonal amplitude in flat space. We are able to resum, in terms of a generalized phase shift, ladder and cross ladder graphs associated to the exchange of a spin  $j$  field, to all orders in the coupling constant. Using the AdS/CFT correspondence, the resulting amplitude determines the behavior of the dual conformal field theory four-point function  $\langle \mathcal{O}_1 \mathcal{O}_2 \mathcal{O}_1 \mathcal{O}_2 \rangle$  for small values of the cross ratios, in a Lorentzian regime. Finally we show that the phase shift is dominated by graviton exchange and computes, in the dual CFT, the anomalous dimension of the double trace primary operators  $\mathcal{O}_1 \partial \cdots \partial \mathcal{O}_2$  of large dimension and spin, corresponding to the relative motion of the two interacting particles. The results are valid at strong t’Hooft coupling and are exact in the  $1/N$  expansion.

# 1 Introduction

In this work we pursue the program, initiated in [1, 2], of applying eikonal methods in the context of the AdS/CFT correspondence [3, 4, 5, 6, 7]. Our main goal is to go beyond the tree level interactions analyzed in [1, 2] and to derive an eikonal formula for hard scattering in AdS. We shall work in the limit of zero string length and consider the expansion in the gravitational coupling  $G$ . This perturbative expansion of pure quantum gravity in AdS is dual to the  $1/N$  expansion of gauge theories with large 't Hooft coupling  $\lambda$ , since  $N^2 G \sim 1$  in units of the AdS radius. In general, this regime of the AdS/CFT correspondence is not tractable. On the gauge theory side, we are working at strong 't Hooft coupling. On the AdS side, one finds the usual UV divergences of the gravitational perturbative expansion. In this paper, we shall show that, in the particular kinematical regime of  $2 \rightarrow 2$  small angle scattering at high energies, the gravitational interaction in AdS can be resummed to all orders in  $G$  using the eikonal approximation. This amplitude determines the dual gauge theory four point function in a particular kinematical regime and it is related to the anomalous dimensions of double trace primary operators with large dimension and spin. Although these results include all terms of the  $1/N$  expansion, there are still finite  $N$  effects that are not captured by our computations. This is the case of instanton effects, which give rise to the usual non-perturbative factor  $e^{-\mathcal{O}(1/g_s)} \sim e^{-\mathcal{O}(N/\lambda)}$ . Therefore we must have  $N \gg \lambda$ , corresponding to small string coupling  $g_s \ll 1$ .

We start in section 2 by rederiving the standard eikonal approximation to ladder and cross ladder diagrams in flat space [8], using Feynman rules in position space. This derivation makes the physical meaning of the eikonal approximation most transparent. Each particle follows a null geodesic corresponding to its classical trajectory, insensitive to the presence of the other. The leading effect of the interaction, at large energy, is then just a phase  $e^{I/4}$  determined by the tree level interaction between the null geodesics  $\mathbf{x}(\lambda)$  and  $\bar{\mathbf{x}}(\bar{\lambda})$  of the incoming particles,

$$I = (-ig)^2 \int_{-\infty}^{\infty} d\lambda d\bar{\lambda} \Pi^{(j)}(\mathbf{x}(\lambda), \bar{\mathbf{x}}(\bar{\lambda})) , \quad (1)$$

where  $g$  is the coupling and  $\Pi^{(j)}$  is the propagator for the exchanged spin  $j$  particle contracted with the external momenta. We shall see in section 3 that this intuitive description generalizes to AdS, resumming therefore ladder and cross ladder Witten diagrams.

In section 4 we shall explore the consequences of the eikonal approximation in AdS for the CFT four point correlator

$$\hat{A}(\mathbf{p}_1, \dots, \mathbf{p}_4) = \langle \mathcal{O}_1(\mathbf{p}_1) \mathcal{O}_2(\mathbf{p}_2) \mathcal{O}_1(\mathbf{p}_3) \mathcal{O}_2(\mathbf{p}_4) \rangle ,$$

of primary operators  $\mathcal{O}_1$  and  $\mathcal{O}_2$ . Using the eikonal approximation in AdS, we establish the behavior of  $\hat{A}$  in the limit of  $\mathbf{p}_1 \sim \mathbf{p}_3$ . The relevant limit is not controlled by the standard OPE, since the eikonal kinematics is intrinsically Lorentzian. Nonetheless, the amplitude  $\hat{A}$  is related to the usual Euclidean correlator  $A$  by analytic continuation and can be easily expressed in terms of the impact parameter representation introduced in [2].

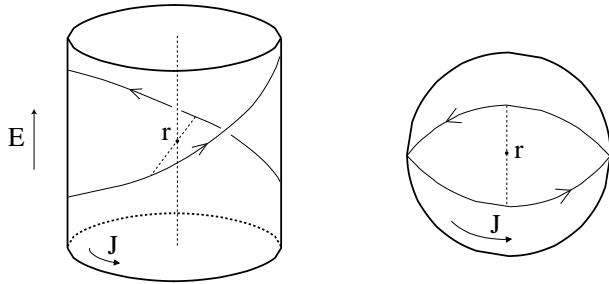

Figure 1: Classical null trajectories of two incoming particles moving in  $\text{AdS}_{d+1}$  with total energy  $E$  and relative angular momentum  $J$ . They reach a minimal impact parameter  $r$  is given by  $\tanh(r/2) = J/E$ .

Finally, still in section 4, we use the relation between  $\hat{A}$  and  $A$  to study the conformal partial wave expansion of the Euclidean correlator  $A$  in the dual channel  $\mathbf{p}_1 \rightarrow \mathbf{p}_2$ . In this channel, the amplitude is dominated, as in flat space, by composite states of the two incoming particles, which are dual to specific composite primary operators  $\mathcal{O}_1 \partial \cdots \partial \mathcal{O}_2$  of classical dimension  $E$  and spin  $J$ . We show that the eikonal approximation to  $\hat{A}$  controls the anomalous dimension  $2\Gamma(E, J)$  of these intermediate two-particle states, in the limit of large  $E, J$ . Heuristically, the basic idea can be summarized in two steps. Firstly, the two incoming particles approximately follow two null geodesics in  $\text{AdS}_{d+1}$  with total energy  $E$  and relative angular momentum  $J$ , as described by Figure 1. The corresponding  $(d-1)$ -dimensional impact parameter space is the transverse hyperboloid  $H_{d-1}$  and the minimal geodesic distance  $r$  between the null geodesics is given by

$$\tanh\left(\frac{r}{2}\right) = \frac{J}{E}.$$

Then, the eikonal approximation determines the phase  $e^{-2\pi i \Gamma}$  due to the exchange of a particle of spin  $j$  and dimension  $\Delta$  in AdS. As described above, this phase shift is determined by the interaction between the two geodesics. We shall see that computing (1) in AdS gives

$$2\Gamma(E, J) \simeq -\frac{g^2}{2\pi} (E^2 - J^2)^{j-1} \Pi_{\perp}(r) \quad (E \sim J \rightarrow \infty), \quad (2)$$

where  $g$  is the coupling in AdS and  $\Pi_{\perp}$  is the Euclidean scalar propagator of dimension  $\Delta - 1$  in the transverse space  $H_{d-1}$ . Secondly, the phase shift is related to the anomalous dimension by the following argument. Recall that [6], due to the conformal structure of AdS, wave functions have discrete allowed frequencies. More precisely, a state of dimension  $\delta$  with only positive frequencies will be almost periodic in global time  $\tau$ , acquiring only a phase  $e^{-2\pi i \delta}$  as  $\tau \rightarrow \tau + 2\pi$ . Since the interaction between the two particles occurs in a global time span of  $\pi$  we conclude that the full dimension of the composite state is  $\delta = E + 2\Gamma(E, J)$ .

As in flat space, we deduce that the leading contribution to  $\Gamma$ , for  $E \sim J \rightarrow \infty$ , is determined completely by the tree level interaction, so that (2) is exact to all orders in the coupling  $g$ . Moreover, in gravitational theories, the leading contribution to  $\Gamma$  comes from the graviton [9],

with  $j = 2$  and  $\Delta = d$ . The result (2) is then valid to all orders in the gravitational coupling  $G = g^2/8\pi$ . For example, in the particular case of the duality between strings on  $\text{AdS}_5 \times S^5$  and four dimensional  $\mathcal{N} = 4$  SYM, the anomalous dimension of the above double trace operators is

$$2\Gamma(E, J) \simeq -\frac{1}{4N^2} \frac{(E - J)^4}{EJ} \quad (E \sim J \rightarrow \infty) ,$$

for  $E - J \ll J$  so that the impact parameter  $r$  is much larger than the  $S^5$  radius  $\ell = 1$  and the effects of massive KK modes are negligible.

We conclude in section 5 by briefly describing the extensions of the results of this work to include string effects, which will appear in a forthcoming publication [10], together with open problems and directions of future research.

## 2 Eikonal Approximation in Position Space

In this section we shall rederive the standard eikonal amplitude for high energy scattering in Minkowski spacetime from a position space perspective. This will prove useful because the physical picture here developed will generalize to scattering in AdS. We shall consider  $(d + 1)$ -dimensional Minkowski space  $\mathbb{M}^{d+1}$  in close analogy with  $\text{AdS}_{d+1}$ . At high energies

$$s = (2\omega)^2$$

we can neglect the masses of the external particles and, for simplicity, we shall consider first an interaction mediated by a scalar field of mass  $m$ . In flat space we may choose the external particle wave functions to be plane waves  $\psi_i(\mathbf{x}) = e^{i\mathbf{k}_i \cdot \mathbf{x}}$  ( $i = 1, \dots, 4$ ), so that the amplitude is a function of the Mandelstam invariants

$$s = -(\mathbf{k}_1 + \mathbf{k}_2)^2 , \quad t = -(\mathbf{k}_1 + \mathbf{k}_3)^2 = -\mathbf{q}^2 ,$$

We then have

$$-2\mathbf{k}_1 \cdot \mathbf{k}_2 = (2\omega)^2 , \quad \mathbf{k}_i^2 = 0 .$$

The eikonal approximation is valid for  $s \gg -t$ , where the momentum transferred  $\mathbf{q} = \mathbf{k}_1 + \mathbf{k}_3$  is approximately orthogonal to the external momenta.

The momenta of the incoming particles naturally decompose spacetime as  $\mathbb{M}^2 \times \mathbb{R}^{d-1}$ . Using coordinates  $\{u, v\}$  in  $\mathbb{M}^2$  and  $\mathbf{w}$  in the transverse space  $\mathbb{R}^{d-1}$ , a generic point can be written using the exponential map

$$\mathbf{x} = e^{v\mathbf{T}_2 + u\mathbf{T}_1} \mathbf{w} = \mathbf{w} + u\mathbf{T}_1 + v\mathbf{T}_2 , \quad (3)$$

where the vector fields  $\mathbf{T}_1$  and  $\mathbf{T}_2$  are defined by

$$\mathbf{T}_1 = \frac{\mathbf{k}_1}{2\omega} , \quad \mathbf{T}_2 = \frac{\mathbf{k}_2}{2\omega} .$$

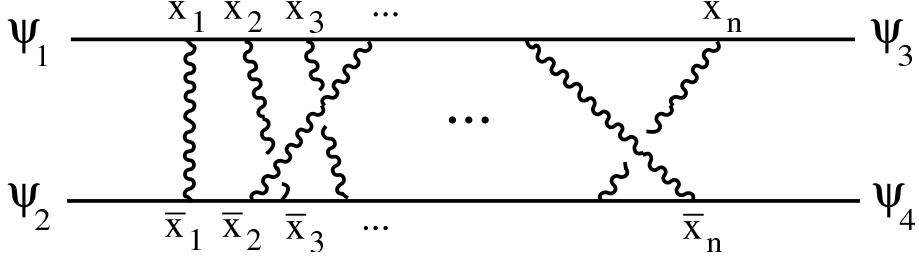

Figure 2: The crossed-ladder graphs describing the  $T$ -channel exchange of many soft particles dominate the scattering amplitude in the eikonal regime.

The incoming wave functions are then

$$\psi_1(\mathbf{x}) = e^{-i\omega v} , \quad \psi_2(\mathbf{x}) = e^{-i\omega u} .$$

The coordinate  $u$  is an affine parameter along the null geodesics describing the classical trajectories of particle 1. This set of null geodesics, labeled by  $v$  and  $\mathbf{w}$ , is then the unique congruence associated with particle 1 trajectories. Since  $\mathbf{T}_2 = \frac{d}{dv}$  is a Killing vector field, these geodesics have a conserved charge  $-\mathbf{T}_2 \cdot \mathbf{k}_1 = \omega$ . At the level of the wave function this charge translates into the condition

$$\mathcal{L}_{\mathbf{T}_2} \psi_1 = -i\omega \psi_1 .$$

Notice also that the wave function  $\psi_1$  is constant along each geodesic of the null congruence,

$$\mathbf{x}(\lambda) = \mathbf{y} + \lambda \mathbf{k}_1 ,$$

where  $\mathbf{k}_1 = 2\omega \frac{d}{du}$  is the momentum vector field associated to particle 1 trajectories. Hence

$$\mathcal{L}_{\mathbf{k}_1} \psi_1 = 0 .$$

Finally, the field equations imply that  $\psi_1$  is independent of the transverse space coordinate  $\mathbf{w}$ . Similar comments apply to particle 2.

Neglecting terms of order  $-t/s$ , the outgoing wave functions for particles 1 and 2 are still independent of the corresponding affine parameter, but depend on the transverse coordinate  $\mathbf{w}$ ,

$$\psi_3(\mathbf{x}) \simeq e^{i\omega v + i\mathbf{q} \cdot \mathbf{w}} , \quad \psi_4(\mathbf{x}) \simeq e^{i\omega u - i\mathbf{q} \cdot \mathbf{w}} .$$

The dependence in transverse space is determined by the transferred momentum  $\mathbf{q}$ . Physically, the transverse space is the impact parameter space. In fact, for two null geodesics associated to the external particles 1 and 2, labeled respectively by  $\{v, \mathbf{w}\}$  and  $\{\bar{u}, \bar{\mathbf{w}}\}$ , the classical impact parameter is given by the distance  $|\mathbf{w} - \bar{\mathbf{w}}|$ .

The exchange of  $n$  scalar particles described by Figure 2 gives the following contribution to

the scattering amplitude

$$\mathcal{A}_n = \frac{(-ig)^{2n}}{V} \int_{\mathbb{M}^{d+1}} d\mathbf{x}_1 \cdots d\mathbf{x}_n d\bar{\mathbf{x}}_1 \cdots d\bar{\mathbf{x}}_n \psi_3(\mathbf{x}_n) \Delta(\mathbf{x}_n - \mathbf{x}_{n-1}) \cdots \Delta(\mathbf{x}_2 - \mathbf{x}_1) \psi_1(\mathbf{x}_1) \\ \psi_4(\bar{\mathbf{x}}_n) \Delta(\bar{\mathbf{x}}_n - \bar{\mathbf{x}}_{n-1}) \cdots \Delta(\bar{\mathbf{x}}_2 - \bar{\mathbf{x}}_1) \psi_2(\bar{\mathbf{x}}_1) \sum_{\text{perm } \sigma} \Delta_m(\mathbf{x}_1 - \bar{\mathbf{x}}_{\sigma_1}) \cdots \Delta_m(\mathbf{x}_n - \bar{\mathbf{x}}_{\sigma_n}) ,$$

where  $V$  is the spacetime volume,  $g$  is the coupling and where  $\Delta(\mathbf{x})$  and  $\Delta_m(\mathbf{x})$  are, respectively, the massless and massive Feynman propagators satisfying

$$(\square - m^2) \Delta_m(\mathbf{x}) = i\delta(\mathbf{x}) .$$

The basic idea of the eikonal approximation is to put the horizontal propagators in Figure 2 almost on-shell. This is usually done in momentum space. For example, for the propagator between vertices  $\mathbf{x}_j$  and  $\mathbf{x}_{j+1}$ , we approximate

$$\frac{-i}{(\mathbf{k}_1 + \mathbf{K})^2 - i\epsilon} \simeq \frac{-i}{2\mathbf{k}_1 \cdot \mathbf{K} - i\epsilon} ,$$

where  $\mathbf{K}$  is the total momentum transferred up to the vertex at  $\mathbf{x}_j$ . The physical meaning of this approximation becomes clear in the coordinates (3),

$$\Delta(\mathbf{x}_{j+1} - \mathbf{x}_j) \simeq -i \int \frac{d\mathbf{K}}{(2\pi)^{d+1}} \frac{e^{i(\mathbf{k}_1 + \mathbf{K}) \cdot (\mathbf{x}_{j+1} - \mathbf{x}_j)}}{2\mathbf{k}_1 \cdot \mathbf{K} - i\epsilon} \\ \simeq \frac{1}{2\omega} \Theta(u_{j+1} - u_j) \delta(v_{j+1} - v_j) \delta^{d-1}(\mathbf{w}_{j+1} - \mathbf{w}_j) . \quad (4)$$

In words, particle 1 can propagate from  $\mathbf{x}_j$  to  $\mathbf{x}_{j+1}$  only if  $\mathbf{x}_{j+1}$  lies on the future directed null geodesic that starts at  $\mathbf{x}_j$  and has tangent vector  $\mathbf{k}_1$ . This intuitive result can be derived directly in position space. In fact, in coordinates (3), the propagator satisfies

$$\square \Delta(x) = (-4\partial_u \partial_v + \partial_{\mathbf{w}}^2) \Delta(u, v, \mathbf{w}) = 2i\delta(u)\delta(v)\delta^{d-1}(\mathbf{w}) .$$

Since for particle 1 we have  $\partial_v = -i\omega$ , for high energies  $\square \simeq 4i\omega\partial_u$  and (4) follows.

The eikonal approximation to the position space propagators greatly simplifies the scattering amplitude for the exchange of  $n$  scalar particles

$$V \mathcal{A}_n \simeq \int_{\mathbb{M}^{d+1}} d\mathbf{x}_1 d\bar{\mathbf{x}}_1 \int_{u_1}^{\infty} du_2 \int_{u_2}^{\infty} du_3 \cdots \int_{u_{n-1}}^{\infty} du_n \int_{\bar{v}_1}^{\infty} d\bar{v}_2 \int_{\bar{v}_2}^{\infty} d\bar{v}_3 \cdots \int_{\bar{v}_{n-1}}^{\infty} d\bar{v}_n \\ (4\omega)^2 \left( \frac{ig}{4\omega} \right)^{2n} e^{i\mathbf{q} \cdot \mathbf{w}} e^{-i\mathbf{q} \cdot \bar{\mathbf{w}}} \sum_{\text{perm } \sigma} \Delta_m(\mathbf{x}_1 - \bar{\mathbf{x}}_{\sigma_1}) \cdots \Delta_m(\mathbf{x}_n - \bar{\mathbf{x}}_{\sigma_n}) ,$$

with

$$\mathbf{x}_j = \mathbf{w} + u_j \mathbf{T}_1 + v \mathbf{T}_2 , \quad \bar{\mathbf{x}}_j = \bar{\mathbf{w}} + \bar{u} \mathbf{T}_1 + \bar{v}_j \mathbf{T}_2 .$$

Furthermore, the sum over permutations can be used to extend the integrals over the affine parameters of external particle trajectories to the full real line,

$$V \mathcal{A}_n \simeq \frac{(2\omega)^2}{n!} \int_{-\infty}^{\infty} dvd\bar{u} \int_{\mathbb{R}^{d-1}} d\mathbf{w}d\bar{\mathbf{w}} e^{i\mathbf{q} \cdot \mathbf{w}} e^{-i\mathbf{q} \cdot \bar{\mathbf{w}}} \left( -\frac{g^2}{16\omega^2} \int_{-\infty}^{\infty} dud\bar{v} \Delta_m(\mathbf{x} - \bar{\mathbf{x}}) \right)^n ,$$

where

$$\mathbf{x} - \bar{\mathbf{x}} = \mathbf{w} + \frac{u - \bar{u}}{2\omega} \mathbf{k}_1 - \bar{\mathbf{w}} - \frac{v - \bar{v}}{2\omega} \mathbf{k}_2 .$$

Summing over  $n$ , one obtains (the  $n = 0$  term corresponds to the disconnected graph)

$$V\mathcal{A} \simeq (2\omega)^2 \int_{-\infty}^{\infty} dv d\bar{u} \int_{\mathbb{R}^{d-1}} d\mathbf{w} d\bar{\mathbf{w}} e^{i\mathbf{q}\cdot\mathbf{w}} e^{-i\mathbf{q}\cdot\bar{\mathbf{w}}} e^{I/4} . \quad (5)$$

The integral  $I$  can be interpreted as the interaction between two null geodesics of momentum  $\mathbf{k}_1$  and  $\mathbf{k}_2$  describing the classical trajectories of the incoming particles. In fact, using as integration variables the natural affine parameters  $\lambda, \bar{\lambda}$  along the geodesics, one has

$$I = (-ig)^2 \int_{-\infty}^{\infty} d\lambda d\bar{\lambda} \Delta_m (\mathbf{w} + \lambda\mathbf{k}_1 - \bar{\mathbf{w}} - \bar{\lambda}\mathbf{k}_2) .$$

Explicit computation yields the Euclidean propagator  $\Delta_{\perp}$  of mass  $m$  in the transverse  $\mathbb{R}^{d-1}$  space

$$I = \frac{-ig^2}{\mathbf{k}_1 \cdot \mathbf{k}_2} \int_{\mathbb{R}^{d-1}} \frac{d\mathbf{k}_{\perp}}{(2\pi)^{d-1}} \frac{e^{i\mathbf{k}_{\perp} \cdot (\mathbf{w} - \bar{\mathbf{w}})}}{\mathbf{k}_{\perp}^2 + m^2} = \frac{2ig^2}{s} \Delta_{\perp}(\mathbf{w} - \bar{\mathbf{w}}) ,$$

and we obtain the well known eikonal amplitude

$$\mathcal{A}(s, t = -\mathbf{q}^2) \simeq 2s \int_{\mathbb{R}^{d-1}} d\mathbf{w} e^{i\mathbf{q}\cdot\mathbf{w} + \frac{ig^2}{2s} \Delta_{\perp}(\mathbf{w})} . \quad (6)$$

The generalization of the above method to interactions mediated by a spin  $j$  particle is now straightforward. We only need to change the integral  $I$  describing the scalar interaction between null geodesics. The spin  $j$  exchange alters the vertices of the local interaction, as well as the propagator of the exchanged particles. In general, the vertex includes  $j$  momentum factors with a complicated index structure. However, in the eikonal regime, the momentum entering the vertices are approximately the incoming momenta  $\mathbf{k}_1, \mathbf{k}_3$ . Therefore, the phase  $I$  should be replaced by <sup>1</sup>

$$I = -g^2 (-2)^j (\mathbf{k}_1)_{\alpha_1} \cdots (\mathbf{k}_1)_{\alpha_j} (\mathbf{k}_2)_{\beta_1} \cdots (\mathbf{k}_2)_{\beta_j} \int_{-\infty}^{\infty} d\lambda d\bar{\lambda} \Delta_m^{\alpha_1 \cdots \alpha_j \beta_1 \cdots \beta_j} (\mathbf{w} + \lambda\mathbf{k}_1 - \bar{\mathbf{w}} - \bar{\lambda}\mathbf{k}_2) ,$$

where  $\Delta_m^{\alpha_1 \cdots \alpha_j \beta_1 \cdots \beta_j}$  is the propagator of the massive spin  $j$  field. Recall that the equations of motion for a spin  $j$  field  $h^{\alpha_1 \cdots \alpha_j}$  imply that  $h$  is symmetric, traceless and transverse ( $\partial_{\alpha_1} h^{\alpha_1 \cdots \alpha_j} = 0$ ), together with the mass-shell condition  $\square = m^2$ . Therefore, the relevant part of the propagator at high energies is given by

$$\eta^{(\alpha_1 \beta_1} \eta^{\alpha_2 \beta_2} \cdots \eta^{\alpha_j \beta_j)} \Delta_m(\mathbf{x} - \bar{\mathbf{x}}) + \cdots ,$$

where the indices  $\alpha_i$  and  $\beta_i$  are separately symmetrized with weight 1. The neglected terms in  $\cdots$  are trace terms, which vanish since  $\mathbf{k}_i^2 = 0$ , and derivative terms acting on  $\Delta_m$ , which

---

<sup>1</sup> The sign  $(-)^j$  indicates that, for odd  $j$ , particles 1 and 2 have opposite charge with respect to the spin  $j$  interaction field. With this convention the interaction is attractive, independently of  $j$ .

vanish after integration along the two interacting geodesics. Compared to the scalar case, we have then an extra factor of  $(-2\mathbf{k}_1 \cdot \mathbf{k}_2)^j = s^j$ , so that

$$I = 2ig^2 s^{j-1} \Delta_{\perp}(\mathbf{w} - \bar{\mathbf{w}}) .$$

Note that we have normalized the coupling  $g^2$  so that the leading behavior of the tree level amplitude at large  $s$  is given by  $-g^2 s^j / t$ . In the particular case of  $j = 2$  we then have  $g^2 = 8\pi G$ , where  $G$  is the canonically normalized Newton constant.

It is known [11, 12] that the eikonal approximation is problematic for  $j = 0$  exchanges. In this case, the large incoming momentum can be exchanged by the mediating particle, interchanging the role of  $u, v$  in intermediate parts of the graph. The eikonal approximation estimates correctly the large  $s$  behavior of the amplitude at each order in perturbation theory, but underestimates the relative coefficients, which do not resum to an exponential. Nonetheless, this is not problematic, since exactly in the  $j = 0$  case the higher order terms are suppressed by powers of  $s^{-1}$ . For  $j \geq 1$  the problematic hard exchanges are suppressed at large energies and the eikonal approximation is valid. On the other hand, for the QED case where  $j = 1$ , there is a different set of graphs involving virtual fermions [12] that dominate the eikonal soft photons exchange. Therefore, also for  $j = 1$ , the validity of the eikonal approximation is in question. None of these problems arise, though, for the most relevant case, the gravitational interaction with  $j = 2$ .

### 3 Eikonal Approximation in Anti-de Sitter

Let us now apply the intuitive picture developed in the previous section to the eikonal approximation in position space to hard scattering in Anti-de Sitter spacetime. Recall that  $\text{AdS}_{d+1}$  space, of dimension  $d+1$  and radius  $\ell = 1$ , can be defined as a pseudo-sphere in the embedding space  $\mathbb{R}^{2,d}$  given by the set of points <sup>2</sup>

$$\mathbf{x} \in \mathbb{R}^{2,d} , \quad \mathbf{x}^2 = -1 . \quad (7)$$

In the remainder of this paper, points, vectors and scalar products are taken in the embedding space  $\mathbb{R}^{2,d}$ , except when extra care is needed with the AdS global structure or when we wish to make contact with the dual CFT notation.

Consider the Feynman graph in Figure 2, but now in AdS. For simplicity, we consider the exchange of an AdS scalar field of dimension  $\Delta$  and, for external fields, we consider scalars of dimension  $\Delta_1$  and  $\Delta_2$ . Then, the graph in Figure 2 evaluates to

$$A_n = (ig)^{2n} \int_{\text{AdS}} d\mathbf{x}_1 \cdots d\mathbf{x}_n d\bar{\mathbf{x}}_1 \cdots d\bar{\mathbf{x}}_n \psi_3(\mathbf{x}_n) \Pi_{\Delta_1}(\mathbf{x}_n, \mathbf{x}_{n-1}) \cdots \Pi_{\Delta_1}(\mathbf{x}_2, \mathbf{x}_1) \psi_1(\mathbf{x}_1) \psi_4(\bar{\mathbf{x}}_n) \Pi_{\Delta_2}(\bar{\mathbf{x}}_n, \bar{\mathbf{x}}_{n-1}) \cdots \Pi_{\Delta_2}(\bar{\mathbf{x}}_2, \bar{\mathbf{x}}_1) \psi_2(\bar{\mathbf{x}}_1) \sum_{\text{perm } \sigma} \Pi_{\Delta}(\mathbf{x}_1, \bar{\mathbf{x}}_{\sigma_1}) \cdots \Pi_{\Delta}(\mathbf{x}_n, \bar{\mathbf{x}}_{\sigma_n}) , \quad (8)$$

---

<sup>2</sup>Rigorously, AdS space is the universal covering of this pseudo-sphere. We shall use units such that  $\ell = 1$ .



where  $\Pi_\Delta(\mathbf{x}, \bar{\mathbf{x}})$  stands for the scalar propagator of mass  $\Delta(\Delta - d)$  in AdS, satisfying

$$[\square_{\text{AdS}} - \Delta(\Delta - d)] \Pi_\Delta(\mathbf{x}, \bar{\mathbf{x}}) = i\delta(\mathbf{x}, \bar{\mathbf{x}}) . \quad (9)$$

In general, this amplitude is very hard to compute. However, we expect some drastic simplifications for specific external wave functions describing highly energetic particles scattering at fixed impact parameters. In analogy with flat space, we expect the eikonal approximation to correspond to the collapse of the propagators  $\Pi_{\Delta_1}$  and  $\Pi_{\Delta_2}$  into null geodesics approximating classical trajectories of highly energetic particles.

### 3.1 Null Congruences in AdS and Wave Functions

A null geodesic in AdS is also a null geodesic in the embedding space

$$\mathbf{x}(\lambda) = \mathbf{y} + \lambda \mathbf{k} ,$$

where  $\mathbf{y} \in \text{AdS}$  and the tangent vector  $\mathbf{k}$  satisfies

$$\mathbf{k}^2 = 0 , \quad \mathbf{k} \cdot \mathbf{y} = 0 .$$

We will follow the intuitive idea that the wave functions  $\psi_1$  and  $\psi_2$  correspond to the initial states of highly energetic particles moving along two intersecting congruences of null geodesics. As described in the previous section, in flat space there is a one-to-one correspondence between null momenta (up to scaling) and congruences of null geodesics. On the other hand, in AdS the situation is more complicated. Given a null vector  $\mathbf{k}$  there is a natural set of null geodesics  $\mathbf{y} + \lambda \mathbf{k}$  passing through all points  $\mathbf{y} \in \text{AdS}$  belonging to the hypersurface  $\mathbf{k} \cdot \mathbf{y} = 0$ , as shown in Figure 3(a). However, to construct a congruence of null geodesics we need to extend this set to the full AdS space. Contrary to flat space, in AdS this extension is not unique because the spacetime conformal boundary is timelike. We will now describe how to construct such a congruence in analogy with the construction presented for flat space.

We start with two null vectors  $\mathbf{k}_1, \mathbf{k}_2$  associated with the incoming particles, as represented in Figure 3(b) and normalized as in flat space

$$-2\mathbf{k}_1 \cdot \mathbf{k}_2 = (2\omega)^2 .$$

The transverse space is naturally defined as the intersection of the two null hypersurfaces associated to  $\mathbf{k}_1$  and  $\mathbf{k}_2$ . It is the hyperboloid  $H_{d-1}$  defined by

$$\mathbf{w} \in \text{AdS} , \quad \mathbf{k}_1 \cdot \mathbf{w} = \mathbf{k}_2 \cdot \mathbf{w} = 0 .$$

In order to introduce coordinates in  $\text{AdS}_{d+1}$  in analogy with (3), we choose an arbitrary reference point  $\mathbf{x}_0$  in this transverse space  $H_{d-1}$ . This allows us to define the vector fields

$$\mathbf{T}_1(\mathbf{x}) = \frac{(\mathbf{k}_1 \cdot \mathbf{x}) \mathbf{x}_0 - (\mathbf{x}_0 \cdot \mathbf{x}) \mathbf{k}_1}{2\omega} , \quad \mathbf{T}_2(\mathbf{x}) = \frac{(\mathbf{k}_2 \cdot \mathbf{x}) \mathbf{x}_0 - (\mathbf{x}_0 \cdot \mathbf{x}) \mathbf{k}_2}{2\omega} ,$$

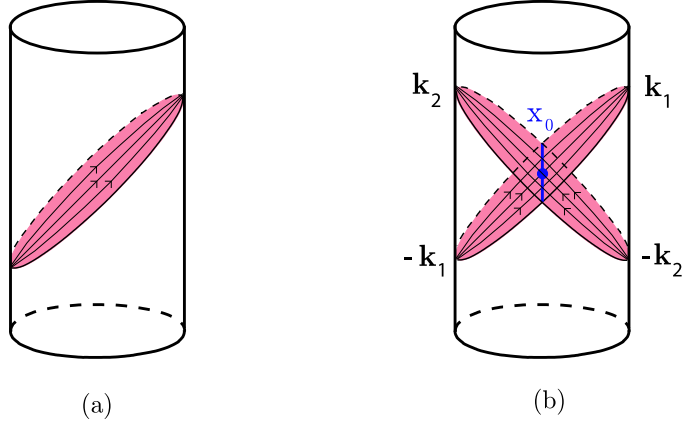

Figure 3: (a) A generic null hypersurface  $\mathbf{k} \cdot \mathbf{y} = 0$  in conformally compactified AdS. (b) The two null hypersurfaces  $\mathbf{k}_1 \cdot \mathbf{y} = 0$  and  $\mathbf{k}_2 \cdot \mathbf{y} = 0$ . Their intersection is the transverse hyperboloid  $H_{d-1}$  containing the reference point  $\mathbf{x}_0$ . We shall see in section 4 that the null vectors  $\mathbf{k}_i$  and  $-\mathbf{k}_i$  can be thought of as points in the AdS conformal boundary.

which, from the embedding space perspective, are respectively the generators of parabolic Lorentz transformations in the  $\mathbf{x}_0 \mathbf{k}_1$  and  $\mathbf{x}_0 \mathbf{k}_2$ -plane. They therefore generate AdS isometries. We may now introduce coordinates  $\{u, v, \mathbf{w}\}$  for  $\mathbf{x} \in \text{AdS}_{d+1}$  as follows

$$\begin{aligned} \mathbf{x} &= e^{v\mathbf{T}_2} e^{u\mathbf{T}_1} \mathbf{w} \\ &= \mathbf{w} - u \frac{(\mathbf{x}_0 \cdot \mathbf{w}) \mathbf{k}_1}{2\omega} - v \frac{(\mathbf{x}_0 \cdot \mathbf{w}) \mathbf{k}_2}{2\omega} + uv \frac{(\mathbf{x}_0 \cdot \mathbf{w}) \mathbf{x}_0}{2} + uv^2 \frac{(\mathbf{x}_0 \cdot \mathbf{w}) \mathbf{k}_2}{8\omega}, \end{aligned} \quad (10)$$

where  $\mathbf{w} \in H_{d-1}$ . It is important to realize that, contrary to the flat space case,  $[\mathbf{T}_1, \mathbf{T}_2] \neq 0$  and therefore the order of the exponential maps in (10) is important, as will become clear below.

As for flat space, the coordinate  $u$  is an affine parameter along null geodesics labeled by  $v$  and  $\mathbf{w}$ , which form the desired congruence for particle 1. In fact, (10) can be written as

$$\mathbf{x} = e^{v\mathbf{T}_2} \mathbf{w} + u e^{v\mathbf{T}_2} \mathbf{T}_1(\mathbf{w}).$$

Hence, the geodesics in the null congruence associated to particle 1 are given by

$$\mathbf{x} = \mathbf{y} + \lambda \mathbf{k}, \quad (11)$$

where

$$\mathbf{y} = e^{v\mathbf{T}_2} \mathbf{w} = \mathbf{w} - v \frac{(\mathbf{x}_0 \cdot \mathbf{w}) \mathbf{k}_2}{2\omega}.$$

The normalization of the momentum  $\mathbf{k}$  and affine parameter  $\lambda$  of the classical trajectories is fixed by demanding, as in flat space, that the conserved charge  $-\mathbf{T}_2 \cdot \mathbf{k} = \omega$ . This gives

$$\begin{aligned} \lambda &= u \frac{(\mathbf{x}_0 \cdot \mathbf{w})^2}{2\omega}, \\ \mathbf{k} &= \frac{2\omega}{(\mathbf{x}_0 \cdot \mathbf{w})^2} e^{v\mathbf{T}_2} \mathbf{T}_1(\mathbf{w}) = \frac{2\omega}{(\mathbf{x}_0 \cdot \mathbf{w})^2} \frac{d}{du} = -\frac{1}{\mathbf{x}_0 \cdot \mathbf{w}} \left( \mathbf{k}_1 - v\omega \mathbf{x}_0 - \frac{v^2}{4} \mathbf{k}_2 \right). \end{aligned}$$

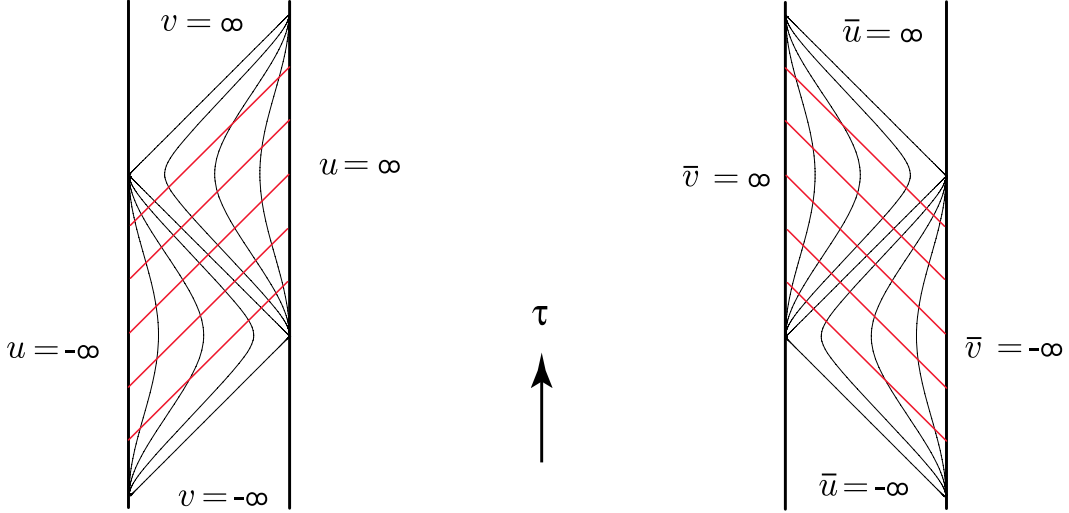

Figure 4: The coordinates  $\{u, v\}$  and  $\{\bar{u}, \bar{v}\}$  for the simplest case of  $\text{AdS}_2$ . In general, the wave function of particle 1 is independent of the coordinate  $u$ , while that of particle 2 is independent of the coordinate  $\bar{v}$ .

Let us we remark that different choices of  $\mathbf{x}_0$  give different congruences, all containing the null geodesics  $\mathbf{w} + \lambda' \mathbf{k}_1$ , which lye on the hypersurface  $\mathbf{k}_1 \cdot \mathbf{x} = 0$  at  $v = 0$ . Starting from this hypersurface, we then constructed a congruence of null geodesics using the AdS isometry generated by  $\mathbf{T}_2$ .

Contrary to flat space, the curves defined by constant  $u$  and  $\mathbf{w}$  in the coordinate system (10) are *not* null geodesics (except for the curves on the surface  $u = 0$  which are null geodesics with affine parameter  $v$ ). These curves are the integral curves of the Killing vector field  $\mathbf{T}_2 = \frac{d}{dv}$ . In fact, these curves are not even null, as can be seen from the form of the AdS metric in these coordinates

$$ds^2 = d\mathbf{w}^2 - (\mathbf{x}_0 \cdot \mathbf{w})^2 dudv - \frac{u^2}{4} (\mathbf{x}_0 \cdot \mathbf{w})^2 dv^2, \quad (12)$$

where  $d\mathbf{w}^2$  is the metric on the hyperboloid  $H_{d-1}$ . To construct the null congruence for particle 2 we introduce new coordinates  $\{\bar{u}, \bar{v}, \bar{\mathbf{w}}\}$  for  $\bar{\mathbf{x}} \in \text{AdS}_{d+1}$  as follows

$$\bar{\mathbf{x}} = e^{\bar{u}\mathbf{T}_1} e^{\bar{v}\mathbf{T}_2} \bar{\mathbf{w}}.$$

The two sets of coordinates are related by

$$\begin{aligned} \bar{u} &= u \left(1 - \frac{uv}{4}\right)^{-1} \\ \bar{v} &= v \left(1 - \frac{uv}{4}\right) \\ \bar{\mathbf{w}} &= \mathbf{w} \end{aligned}$$

The congruence associated with particle 2 is then the set of null geodesics

$$\bar{\mathbf{x}} = \bar{\mathbf{y}} + \bar{\lambda} \bar{\mathbf{k}}, \quad (13)$$

with

$$\begin{aligned}\bar{\mathbf{y}} &= e^{\bar{u}\mathbf{T}_1} \bar{\mathbf{w}} = \bar{\mathbf{w}} - \bar{u} \frac{(\mathbf{x}_0 \cdot \bar{\mathbf{w}}) \mathbf{k}_1}{2\omega} , \\ \bar{\lambda} &= \bar{v} \frac{(\mathbf{x}_0 \cdot \bar{\mathbf{w}})^2}{2\omega} , \\ \bar{\mathbf{k}} &= \frac{2\omega}{(\mathbf{x}_0 \cdot \bar{\mathbf{w}})^2} e^{\bar{u}\mathbf{T}_1} \mathbf{T}_2(\bar{\mathbf{w}}) = \frac{2\omega}{(\mathbf{x}_0 \cdot \bar{\mathbf{w}})^2} \frac{d}{d\bar{v}} = -\frac{1}{\mathbf{x}_0 \cdot \bar{\mathbf{w}}} \left( \mathbf{k}_2 - \bar{u}\omega \mathbf{x}_0 - \frac{\bar{u}^2}{4} \mathbf{k}_1 \right) ,\end{aligned}$$

so that the conserved charge  $-\mathbf{T}_1 \cdot \bar{\mathbf{k}} = \omega$ . In Figure 4 we plot the curves of constant  $u$  and  $v$  (left) and of constant  $\bar{u}$  and  $\bar{v}$  (right) in the simplest case of AdS<sub>2</sub>.

As in flat space, the wave function describing particle 1 carries energy  $\omega$

$$\mathcal{L}_{\mathbf{T}_2} \psi_1 = \partial_v \psi_1 \simeq -i\omega \psi_1 .$$

Therefore we choose

$$\psi_1(\mathbf{x}) = e^{-i\omega v} F_1(\mathbf{x}) ,$$

where the function  $F_1$  is approximately constant over the length scale  $1/\omega$ , more precisely  $|\partial F_1| \ll \omega |F_1|$ . The Klein–Gordon equation for the wave function  $\psi_1$  implies

$$\left[ \frac{4i\omega}{(\mathbf{x}_0 \cdot \mathbf{w})^2} \partial_u + \square_{\text{AdS}} - \Delta_1(\Delta_1 - d) \right] F_1(\mathbf{x}) = 0 ,$$

since, as in flat space, the coordinate  $v$  satisfies

$$\square_{\text{AdS}} v = (\nabla v)^2 = 0 .$$

The above equation can then be solved expanding  $F_1$  in powers of  $1/\omega$ ,

$$F_1(\mathbf{x}) = F_1(v, \mathbf{w}) - \frac{(\mathbf{x}_0 \cdot \mathbf{w})^2}{4i\omega} \int du \left[ \square_{\text{AdS}} - \Delta_1(\Delta_1 - d) \right] F_1(v, \mathbf{w}) + \dots$$

Since the eikonal approximation gives only the leading behavior of the scattering amplitude at large  $\omega$ , it is enough to consider only the first term  $F_1(\mathbf{x}) \simeq F_1(v, \mathbf{w})$  so that, to this order, we have

$$\mathcal{L}_{\mathbf{k}} \psi_1 = 0 ,$$

as expected. We conclude that the function  $F_1$  is a smooth transverse modulation independent of the affine parameter  $\lambda$  of the null geodesics associated with the classical trajectories of particle 1. Similar reasoning applied to particle 2 leads to

$$\psi_2(\bar{\mathbf{x}}) \simeq e^{-i\omega \bar{u}} F_2(\bar{u}, \bar{\mathbf{w}}) .$$

Finally, since in the eikonal regime the particles are only slightly deviated by the scattering process, to leading order in  $1/\omega$  the outgoing wave functions are also independent of the corresponding affine parameters,

$$\psi_3(\mathbf{x}) \simeq e^{i\omega v} F_3(v, \mathbf{w}) , \quad \psi_4(\bar{\mathbf{x}}) \simeq e^{i\omega \bar{u}} F_4(\bar{u}, \bar{\mathbf{w}}) ,$$

with the same requirement  $|\partial F| \ll \omega|F|$ .

We have kept the discussion of this section completely coordinate independent. On the other hand, given the choice of  $\mathbf{k}_1$  and  $\mathbf{k}_2$ , the embedding space  $\mathbb{R}^{2,d}$  naturally splits into  $\mathbb{M}^2 \times \mathbb{M}^d$ , with  $\mathbb{M}^2$  spanned by  $\mathbf{k}_1$  and  $\mathbf{k}_2$  and with  $\mathbb{M}^d$  its orthogonal complement. We may then introduce coordinates  $\mathbf{x} = (x^+, x^-, x^a)$  where  $x^\pm$  are light-cone coordinates on  $\mathbb{M}^2$  and where the  $x^a$  parametrize  $\mathbb{M}^d$ . We shall often omit the explicit label  $a$ . AdS is then given by

$$\mathbf{x}^2 = -x^+x^- + x \cdot x = -1.$$

In terms of these coordinates we have that

$$\mathbf{k}_1 = -2\omega(0, 1, 0), \quad \mathbf{k}_2 = -2\omega(1, 0, 0)$$

and

$$\mathbf{x}_0 = (0, 0, x_0), \quad \mathbf{w} = (0, 0, w), \quad \bar{\mathbf{w}} = (0, 0, \bar{w}). \quad (14)$$

Then, the vector fields  $\mathbf{T}_1$  and  $\mathbf{T}_2$  are simply the parabolic Poincaré translations

$$\begin{aligned} \mathbf{T}_1 &= \frac{1}{2}x^+(x_0 \cdot \partial) + (x_0 \cdot x)\partial_-, \\ \mathbf{T}_2 &= \frac{1}{2}x^-(x_0 \cdot \partial) + (x_0 \cdot x)\partial_+. \end{aligned}$$

The action of  $e^{\alpha\mathbf{T}_1}$  is simple in the Poincaré parametrization  $\mathbf{x} = 1/r(1, r^2 + y^2, y)$  and corresponds to translations  $y \rightarrow y + (\alpha/2)x_0$  in the time direction indicated by  $x_0$ . This corresponds to

$$\begin{aligned} x^- &\rightarrow x^- + \alpha x_0 \cdot x + \frac{\alpha^2}{4}x^+, \\ x &\rightarrow x + \frac{\alpha}{2}x^+x_0, \end{aligned}$$

with  $x^+$  fixed. Similar remarks apply to  $\mathbf{T}_2$  with the roles of  $x^+$  and  $x^-$  interchanged.

## 3.2 Eikonal Amplitude

We are now in position to compute the leading behavior of the amplitude (8) for the exchange of  $n$  scalars in AdS at large  $\omega$ , using the techniques explained in section 2. The first step is to obtain an approximation for the AdS propagator similar to (4). Since for particle 1 we have  $\partial_v \simeq -i\omega$ , we can approximate

$$\square_{\text{AdS}} \simeq \frac{4i\omega}{(\mathbf{x}_0 \cdot \mathbf{w})^2} \partial_u,$$

in equation (9) for the propagator of particle 1 between vertices  $\mathbf{x}_j$  and  $\mathbf{x}_{j+1}$ , obtaining

$$\frac{4i\omega}{(\mathbf{x}_0 \cdot \mathbf{w})^2} \partial_{u_j} \Pi_{\Delta_1}(\mathbf{x}_j, \mathbf{x}_{j+1}) = \frac{2i}{(\mathbf{x}_0 \cdot \mathbf{w})^2} \delta(u_j - u_{j+1}) \delta(v_j - v_{j+1}) \delta_{H_{d-1}}(\mathbf{w}_j, \mathbf{w}_{j+1}).$$

The solution,

$$\Pi_{\Delta_1}(\mathbf{x}_j, \mathbf{x}_{j+1}) \simeq \frac{1}{2\omega} \Theta(u_j - u_{j+1}) \delta(v_j - v_{j+1}) \delta_{H_{d-1}}(\mathbf{w}_j, \mathbf{w}_{j+1}) ,$$

has the natural interpretation of propagation only along the particle classical trajectory and, in these coordinates, takes almost exactly the same form as the corresponding propagator (4) in flat space. With this approximation to the propagator, the amplitude (8) associated with the exchange of  $n$  scalar particles simplifies to

$$\begin{aligned} A_n \simeq & (2\omega)^2 \int_{-\infty}^{\infty} dv d\bar{u} \int_{H_{d-1}} d\mathbf{w} d\bar{\mathbf{w}} F_1(v, \mathbf{w}) F_3(v, \mathbf{w}) F_2(\bar{u}, \bar{\mathbf{w}}) F_4(\bar{u}, \bar{\mathbf{w}}) \\ & \int_{-\infty}^{\infty} du_1 \int_{u_1}^{\infty} du_2 \cdots \int_{u_{n-1}}^{\infty} du_n \int_{-\infty}^{\infty} d\bar{v}_1 \int_{\bar{v}_1}^{\infty} d\bar{v}_2 \cdots \int_{\bar{v}_{n-1}}^{\infty} d\bar{v}_n \\ & \left( \frac{ig(\mathbf{x}_0 \cdot \mathbf{w})(\mathbf{x}_0 \cdot \bar{\mathbf{w}})}{4\omega} \right)^{2n} \sum_{\text{perm } \sigma} \Pi_{\Delta}(\mathbf{x}_1, \bar{\mathbf{x}}_{\sigma_1}) \cdots \Pi_{\Delta}(\mathbf{x}_n, \bar{\mathbf{x}}_{\sigma_n}) , \end{aligned}$$

where

$$\mathbf{x}_j = e^{v\mathbf{T}_2} e^{u_j\mathbf{T}_1} \mathbf{w} , \quad \bar{\mathbf{x}}_j = e^{\bar{u}\mathbf{T}_1} e^{\bar{v}_j\mathbf{T}_2} \bar{\mathbf{w}} .$$

Notice that the extra powers of  $(\mathbf{x}_0 \cdot \mathbf{w})^2/2$  and  $(\mathbf{x}_0 \cdot \bar{\mathbf{w}})^2/2$  come from the integration measure in the  $\mathbf{x}_j$  and  $\bar{\mathbf{x}}_j$  coordinates, respectively. As for flat space, the integrals over the affine parameters can be extended to the real line so that, after summing over  $n$ , we obtain

$$A \simeq (2\omega)^2 \int_{-\infty}^{\infty} dv d\bar{u} \int_{H_{d-1}} d\mathbf{w} d\bar{\mathbf{w}} F_1(v, \mathbf{w}) F_3(v, \mathbf{w}) F_2(\bar{u}, \bar{\mathbf{w}}) F_4(\bar{u}, \bar{\mathbf{w}}) e^{I/4} , \quad (15)$$

with

$$I = -\frac{g^2(\mathbf{x}_0 \cdot \mathbf{w})^2(\mathbf{x}_0 \cdot \bar{\mathbf{w}})^2}{(2\omega)^2} \int_{-\infty}^{\infty} dud\bar{v} \Pi_{\Delta}(\mathbf{x}, \bar{\mathbf{x}}) .$$

This can be rewritten as the tree-level interaction between two classical trajectories of the incoming particles described by (11) and (13), which are labeled respectively by  $\mathbf{y}$  and  $\bar{\mathbf{y}}$ ,

$$I = (-ig)^2 \int_{-\infty}^{\infty} d\lambda d\bar{\lambda} \Pi_{\Delta}(\mathbf{y} + \lambda \mathbf{k}(\mathbf{y}), \bar{\mathbf{y}} + \bar{\lambda} \bar{\mathbf{k}}(\bar{\mathbf{y}})) .$$

Hence, the AdS eikonal amplitude just obtained is the direct analogue of the corresponding flat space amplitude (5).

The generalization of the above result to the case of interactions mediated by a minimally coupled particle of spin  $j$  is straightforward, and we shall only give the relevant results. At high energies, the only change concerns the propagator  $\Pi_{\Delta}$ , which now should be replaced by the propagator of the spin- $j$  particle contracted with the null momenta of the geodesics

$$\Pi_{\Delta}^{(j)} = (-2)^j \mathbf{k}_{\alpha_1} \cdots \mathbf{k}_{\alpha_j} \bar{\mathbf{k}}_{\beta_1} \cdots \bar{\mathbf{k}}_{\beta_j} \Pi_{\Delta}^{\alpha_1, \dots, \alpha_j, \beta_1, \dots, \beta_j} ,$$

where the indices  $\alpha_i, \beta_j$  are tangent indices to AdS. This follows immediately from the fact that, at high energies, covariant derivatives  $-i\nabla_{\alpha}$  in interaction vertices can be replaced by  $\mathbf{k}_{\alpha}$

and  $\bar{\mathbf{k}}_\alpha$  for particle one and two, respectively. The spin- $j$  propagator is totally symmetric and traceless in the indices  $\alpha_1 \dots \alpha_j$  (and similarly in the indices  $\beta_1 \dots \beta_j$ ), it is divergenceless and satisfies

$$[\square - \Delta(\Delta - d) + j] \Pi_\Delta^{\alpha_1, \dots, \alpha_j, \beta_1, \dots, \beta_j}(\mathbf{x}, \bar{\mathbf{x}}) = i g^{(\alpha_1 \beta_1} g^{\alpha_2 \beta_2} \dots g^{\alpha_j \beta_j)} \delta(\mathbf{x}, \bar{\mathbf{x}}) + \dots, \quad (16)$$

where the indices  $\alpha_i$  and  $\beta_i$  are separately symmetrized, and where the terms in  $\dots$  contain derivatives of  $\delta(\mathbf{x}, \bar{\mathbf{x}})$  and are not going to be of relevance to the discussion which follows, since they give subleading contributions at high energies. The eikonal expression (15) is then valid in general, with the phase factor  $I$  now replaced by

$$I = -g^2 \int_{-\infty}^{\infty} d\lambda d\bar{\lambda} \Pi_\Delta^{(j)}(\mathbf{y} + \lambda \mathbf{k}, \bar{\mathbf{y}} + \bar{\lambda} \bar{\mathbf{k}}).$$

Note that we have normalized the interaction coupling as in flat space, where the tree level interaction is given by  $-g^2 s^j/t$  at large  $s$ .

### 3.3 Transverse Propagator

Now we compute the integral  $I$ . Its last expression shows that it is a Lorentz invariant local function of  $\mathbf{y}, \bar{\mathbf{y}}, \mathbf{k}$  and  $\bar{\mathbf{k}}$ . Moreover, it is invariant under

$$\mathbf{y} \rightarrow \mathbf{y} + \alpha \mathbf{k}, \quad \bar{\mathbf{y}} \rightarrow \bar{\mathbf{y}} + \bar{\alpha} \bar{\mathbf{k}},$$

and it scales like  $I \rightarrow (\alpha \bar{\alpha})^{j-1} I$  when  $\mathbf{k} \rightarrow \alpha \mathbf{k}$  and  $\bar{\mathbf{k}} \rightarrow \bar{\alpha} \bar{\mathbf{k}}$ . Therefore, the integral  $I$  is fixed up to an undetermined function  $G$ ,

$$\begin{aligned} I &= 2ig^2 (-2\mathbf{k} \cdot \bar{\mathbf{k}})^{j-1} G \left( \mathbf{y} \cdot \bar{\mathbf{y}} - \frac{(\mathbf{k} \cdot \bar{\mathbf{y}})(\bar{\mathbf{k}} \cdot \mathbf{y})}{\mathbf{k} \cdot \bar{\mathbf{k}}} \right) \\ &= 2ig^2 s^{j-1} G(\mathbf{w} \cdot \bar{\mathbf{w}}), \end{aligned}$$

with  $s$  defined in analogy with flat space

$$s = -2\mathbf{k} \cdot \bar{\mathbf{k}} = (2\omega)^2 \frac{(1 + v\bar{u}/4)^2}{(\mathbf{x}_0 \cdot \mathbf{w})(\bar{\mathbf{x}}_0 \cdot \bar{\mathbf{w}})}. \quad (17)$$

To determine the function  $G$  we use equation (16), contracting both sides with

$$(-2)^j \mathbf{k}_{\alpha_1} \dots \mathbf{k}_{\alpha_j} \bar{\mathbf{k}}_{\beta_1} \dots \bar{\mathbf{k}}_{\beta_j}$$

and integrating against

$$\int_{-\infty}^{\infty} dud\bar{v} = \frac{(2\omega)^2}{(\mathbf{x}_0 \cdot \mathbf{w})^2 (\bar{\mathbf{x}}_0 \cdot \bar{\mathbf{w}})^2} \int_{-\infty}^{\infty} d\lambda d\bar{\lambda}.$$

Here we discuss the simplest case of  $j = 0$ , leaving the general case to appendix A. Consider then first the integral of the RHS of (9). Using the explicit form of the  $\delta$ -function in the  $\{u, v, \mathbf{w}\}$  coordinate system,

$$\delta(\mathbf{x}, \bar{\mathbf{x}}) = \frac{2}{(\mathbf{x}_0 \cdot \mathbf{w})^2} \delta_{H_{d-1}}(\mathbf{w}, \bar{\mathbf{w}}) \delta \left( u - \bar{u} \left( 1 - \frac{\bar{u}\bar{v}}{4} \right) \right) \delta \left( v - \bar{v} \left( 1 - \frac{\bar{u}\bar{v}}{4} \right)^{-1} \right),$$

we obtain

$$\frac{2i}{(1 + v\bar{u}/4)^2(\mathbf{x}_0 \cdot \mathbf{w})^2} \delta_{H_{d-1}}(\mathbf{w}, \bar{\mathbf{w}}) . \quad (18)$$

Next we consider the LHS of (9). Explicitly parametrizing the metric  $d\mathbf{w}^2$  on  $H_{d-1}$  in (12) as

$$d\mathbf{w}^2 = \frac{d\chi^2}{\chi^2 - 1} + (\chi^2 - 1)ds^2(S_{d-2}),$$

where  $\chi = -\mathbf{x}_0 \cdot \mathbf{w}$ , we have that

$$\square_{\text{AdS}}\Pi_\Delta = \left[ \square_{H_{d-1}} + 2 \frac{\chi^2 - 1}{\chi} \partial_\chi \right] \Pi_\Delta + \partial_u(\dots),$$

where we do not show the explicit terms of the form  $\partial_u(\dots)$  since they will vanish once integrated along the two geodesics. Integrating in  $dud\bar{v}$  we conclude that (18) must be equated to

$$-\frac{2i}{(1 + v\bar{u}/4)^2} \left[ \square_{H_{d-1}} - \Delta(\Delta - d) + 2 \frac{\chi^2 - 1}{\chi} \partial_\chi \right] \frac{G(\mathbf{w}, \bar{\mathbf{w}})}{\chi\bar{\chi}} .$$

Using the fact that

$$[\square_{H_{d-1}}, \chi^{-1}] = \frac{1}{\chi} \left( -2 \frac{\chi^2 - 1}{\chi} \partial_\chi + (3 - d) - \frac{2}{\chi^2} \right) ,$$

we finally deduce that

$$[\square_{H_{d-1}} + 1 - d - \Delta(\Delta - d)] G(\mathbf{w} \cdot \bar{\mathbf{w}}) = -\delta(\mathbf{w}, \bar{\mathbf{w}}) .$$

In appendix A we show that this last equation is also valid for general spin  $j$ . We conclude that the function  $G$  is the scalar Euclidean propagator in the hyperboloid  $H_{d-1}$  of mass squared  $(\Delta - 1)(\Delta - 1 - d + 2)$  and corresponding dimension  $\Delta - 1$ . Denoting this propagator by  $\Pi_\perp(\mathbf{w}, \bar{\mathbf{w}})$ , the eikonal amplitude can be written as

$$A \simeq (2\omega)^2 \int_{-\infty}^{\infty} dv d\bar{u} \int_{H_{d-1}} d\mathbf{w} d\bar{\mathbf{w}} F_1(v, \mathbf{w}) F_3(v, \mathbf{w}) F_2(\bar{u}, \bar{\mathbf{w}}) F_4(\bar{u}, \bar{\mathbf{w}}) \exp\left(\frac{ig^2}{2} s^{j-1} \Pi_\perp(\mathbf{w}, \bar{\mathbf{w}})\right) , \quad (19)$$

with  $s$  given by (17).

### 3.4 Localized Wave Functions

The eikonal amplitude in AdS has a striking similarity with the standard flat space eikonal amplitude. However, an important difference is the factor  $(1 + \frac{v\bar{u}}{4})^2$  in the definition (17) of  $s$ , which makes the exponent in the eikonal amplitude (19) diverge for  $v\bar{u} = -4$  and  $j = 0$ . This divergence can be traced back to the colinearity of the tangent vectors  $\mathbf{k}$  and  $\bar{\mathbf{k}}$  of the null geodesics labeled by  $\{v, \mathbf{w}\}$  and  $\{\bar{u}, \bar{\mathbf{w}}\}$  describing classical trajectories of particle 1 and 2, respectively. When  $v\bar{u} = -4$ , one null geodesic can be seen as the reflection of the other on the



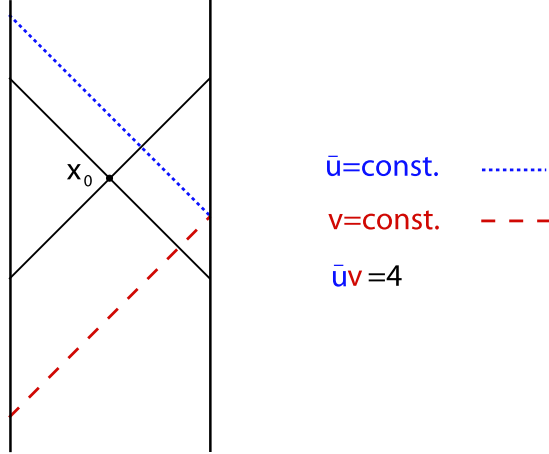

Figure 5: The null geodesics with constant  $\bar{u} = -4/v$  are the reflection in the AdS conformal boundary of the null geodesics with constant  $v$ .

AdS boundary (see Figure 5). Thus, the propagator from a point on one geodesic to a point in the other, diverges since these points are connected by a null geodesic. This is the physical meaning of the divergence at  $v\bar{u} = -4$ . Clearly, we should doubt the accuracy of the eikonal approximation in this case of very strong interference. To avoid this annoying divergence, from now on we shall localize the external wave functions of particle 1 and 2 around  $v = 0$  and  $\bar{u} = 0$ , respectively. More precisely, we shall choose

$$\begin{aligned} \psi_1(\mathbf{x}) &\simeq e^{-i\omega v} F(v) F_1(\mathbf{w}) , & \psi_2(\bar{\mathbf{x}}) &\simeq e^{-i\omega \bar{u}} F(\bar{u}) F_2(\bar{\mathbf{w}}) , \\ \psi_3(\mathbf{x}) &\simeq e^{i\omega v} F^*(v) F_3(\mathbf{w}) , & \psi_4(\bar{\mathbf{x}}) &\simeq e^{i\omega \bar{u}} F^*(\bar{u}) F_4(\bar{\mathbf{w}}) , \end{aligned} \quad (20)$$

where the profile  $F(\alpha)$  is localized in the region  $|\alpha| < \Lambda \ll 1$  and it is normalized as

$$\int_{-\infty}^{\infty} d\alpha |F(\alpha)|^2 = \sqrt{2} . \quad (21)$$

On the other hand, the smoothness condition  $|\partial F| \ll \omega|F|$  requires  $\Lambda \gg 1/\omega$ . The two conditions,

$$1/\omega \ll \Lambda \ll 1 ,$$

are compatible for high energy scattering, when the de Broglie wavelength of the external particles is much shorter than the radius of AdS ( $\ell = 1$ ). With this choice of external wave functions, the amplitude simplifies to

$$A_{eik} \simeq 8\omega^2 \int_{H_{d-1}} d\mathbf{w} d\bar{\mathbf{w}} F_1(\mathbf{w}) F_3(\mathbf{w}) F_2(\bar{\mathbf{w}}) F_4(\bar{\mathbf{w}}) \exp\left(\frac{ig^2}{2} s^{j-1} \Pi_{\perp}(\mathbf{w}, \bar{\mathbf{w}})\right) , \quad (22)$$

where now

$$s = \frac{(2\omega)^2}{(\mathbf{x}_0 \cdot \mathbf{w})(\mathbf{x}_0 \cdot \bar{\mathbf{w}})} . \quad (23)$$

## 4 Relation to the Dual CFT

The AdS/CFT correspondence predicts the existence of a dual CFT<sub>*d*</sub> living on the boundary of AdS<sub>*d*+1</sub>. In particular, the AdS scattering amplitude we determined in the previous section is directly related to the CFT four point–function of scalar primary operators. We shall now explore this connection to find properties of four–point functions in CFTs with AdS duals.

Firstly, we must introduce some convenient notation [1, 2]. The boundary of AdS can be thought of as the set of null rays through the origin of the embedding space  $\mathbb{R}^{2,d}$ . More precisely, a point in the boundary of AdS is given by

$$\mathbf{p} \in \mathbb{R}^{2,d} , \quad \mathbf{p}^2 = 0 , \quad \mathbf{p} \sim \lambda \mathbf{p} \quad (\lambda > 0) .$$

In this language, a CFT correlator of scalar primary operators located at points  $\mathbf{p}_1, \dots, \mathbf{p}_n$  is described by an amplitude

$$A(\mathbf{p}_1, \dots, \mathbf{p}_n)$$

invariant under  $SO(2, d)$  and therefore only a function of the invariants  $\mathbf{p}_i \cdot \mathbf{p}_j$ . Moreover, since the boundary points  $\mathbf{p}_i$  are defined only up to rescaling, the amplitude  $A$  will be homogeneous in each entry

$$A(\dots, \lambda \mathbf{p}_i, \dots) = \lambda^{-\Delta_i} A(\dots, \mathbf{p}_i, \dots) ,$$

where  $\Delta_i$  is the conformal dimension of the  $i$ –th scalar primary operator.

The AdS scattering amplitude considered in the previous section is directly related to the correlator

$$A(\mathbf{p}_1, \mathbf{p}_2, \mathbf{p}_3, \mathbf{p}_4) = \langle \mathcal{O}_1(\mathbf{p}_1) \mathcal{O}_2(\mathbf{p}_2) \mathcal{O}_1(\mathbf{p}_3) \mathcal{O}_2(\mathbf{p}_4) \rangle_{\text{CFT}_d} ,$$

where the scalar primary operators  $\mathcal{O}_1$  and  $\mathcal{O}_2$  have dimensions  $\Delta_1$  and  $\Delta_2$ , respectively. The four–point amplitude  $A$  is just a function of two cross–ratios  $z, \bar{z}$  which we define, following [13, 14], in terms of the kinematical invariants as <sup>3</sup>

$$\begin{aligned} z\bar{z} &= \frac{(\mathbf{p}_1 \cdot \mathbf{p}_3)(\mathbf{p}_2 \cdot \mathbf{p}_4)}{(\mathbf{p}_1 \cdot \mathbf{p}_2)(\mathbf{p}_3 \cdot \mathbf{p}_4)} , \\ (1-z)(1-\bar{z}) &= \frac{(\mathbf{p}_1 \cdot \mathbf{p}_4)(\mathbf{p}_2 \cdot \mathbf{p}_3)}{(\mathbf{p}_1 \cdot \mathbf{p}_2)(\mathbf{p}_3 \cdot \mathbf{p}_4)} . \end{aligned} \tag{24}$$

Then, the four–point amplitude can be written as

$$A(\mathbf{p}_1, \mathbf{p}_2, \mathbf{p}_3, \mathbf{p}_4) = K_{\Delta_1}(\mathbf{p}_1, \mathbf{p}_3) K_{\Delta_2}(\mathbf{p}_2, \mathbf{p}_4) \mathcal{A}(z, \bar{z}) ,$$

where  $\mathcal{A}$  is a generic function of  $z, \bar{z}$  and  $K_{\Delta}(\mathbf{p}, \mathbf{p}')$  is the boundary propagator of conformal dimension  $\Delta$  defined below. With this normalization, the disconnected graph gives  $\mathcal{A} = 1$ .

---

<sup>3</sup>Throughout the paper, we shall consider barred and unbarred variables as independent, with complex conjugation denoted by  $\star$ . In general  $\bar{z} = z^\star$  when considering the analytic continuation of the CFT<sub>*d*</sub> to Euclidean signature. For Lorentzian signature, either  $\bar{z} = z^\star$  or both  $z$  and  $\bar{z}$  are real. These facts follow simply from solving the quadratic equations for  $z$  and  $\bar{z}$ .

By the AdS/CFT correspondence, CFT correlators can be computed using string theory in Anti de–Sitter spacetime. We shall work in the limit of small string length compared to the radius of AdS, where the supergravity description is valid. In this regime, the above four–point correlator is given by the sum of all Feynman–Witten diagrams like the one in Figure 2, with bulk to boundary propagators  $K_{\Delta}(\mathbf{p}, \mathbf{x})$  as external wave functions,

$$\begin{aligned}\psi_1(\mathbf{x}) &= K_{\Delta_1}(\mathbf{p}_1, \mathbf{x}) , & \psi_2(\mathbf{x}) &= K_{\Delta_2}(\mathbf{p}_2, \mathbf{x}) , \\ \psi_3(\mathbf{x}) &= K_{\Delta_1}(\mathbf{p}_3, \mathbf{x}) , & \psi_4(\mathbf{x}) &= K_{\Delta_2}(\mathbf{p}_4, \mathbf{x}) .\end{aligned}$$

More generally, we can prepare any on–shell wave function in the bulk by superposing bulk to boundary propagators from many boundary points. For example,

$$\psi_1(\mathbf{x}) = \int_{\Sigma} d\mathbf{p}_1 \phi_1(\mathbf{p}_1) K_{\Delta_1}(\mathbf{p}_1, \mathbf{x}) ,$$

where the boundary integration is done along a specific section  $\Sigma$  of the light–cone, with metric induced by the embedding space. Choosing a different section corresponds to conformal transformations of the boundary. The boundary wave function  $\phi_1(\mathbf{p}_1)$  must be a homogeneous function of weight  $\Delta_1 - d$ ,

$$\phi_1(\lambda\mathbf{p}_1) = \lambda^{\Delta_1-d} \phi_1(\mathbf{p}_1) ,$$

so that the integral is invariant under conformal transformations of the boundary. Therefore, given boundary wave functions  $\phi_i$ , such that the corresponding bulk wave functions  $\psi_i$  are of the eikonal type as defined in the previous section, we have

$$\int_{\Sigma} d\mathbf{p}_1 \cdots d\mathbf{p}_4 \phi_1(\mathbf{p}_1) \cdots \phi_4(\mathbf{p}_4) A(\mathbf{p}_1, \mathbf{p}_2, \mathbf{p}_3, \mathbf{p}_4) \simeq A_{eik} ,$$

where  $A_{eik}$  is given by (22).

## 4.1 CFT Eikonal Kinematics

In order to construct the relevant eikonal wave functions, we shall need to analyze more carefully the global structure of AdS. Consider a point  $\mathbf{Q}$ , either in AdS or on its boundary. The future and past light–cones starting from  $\mathbf{Q}$  divide global AdS and its boundary into an infinite sequence of regions, which we label by an integer. Given a generic point  $\mathbf{Q}'$ , we introduce the integral function  $n(\mathbf{Q}', \mathbf{Q})$  which vanishes when  $\mathbf{Q}'$  is space–like related to  $\mathbf{Q}$  and which increases (decreases) as  $\mathbf{Q}'$  moves forward (backward) in global time and crosses the light cone of  $\mathbf{Q}$ . Clearly  $n(\mathbf{Q}, \mathbf{Q}') = -n(\mathbf{Q}', \mathbf{Q})$ . In terms of the function  $n(\mathbf{Q}', \mathbf{Q})$ , the boundary and the bulk to boundary propagators  $K_{\Delta}(\mathbf{p}, \mathbf{p}')$  and  $K_{\Delta}(\mathbf{p}, \mathbf{x})$  are given by

$$K_{\Delta}(\mathbf{p}, \mathbf{p}') = \frac{\mathcal{C}_{\Delta}}{|2\mathbf{p} \cdot \mathbf{p}'|^{\Delta}} i^{-2\Delta|n(\mathbf{p}, \mathbf{p}')|} , \quad K_{\Delta}(\mathbf{p}, \mathbf{x}) = \frac{\mathcal{C}_{\Delta}}{|2\mathbf{p} \cdot \mathbf{x}|^{\Delta}} i^{-2\Delta|n(\mathbf{p}, \mathbf{x})|} , \quad (25)$$

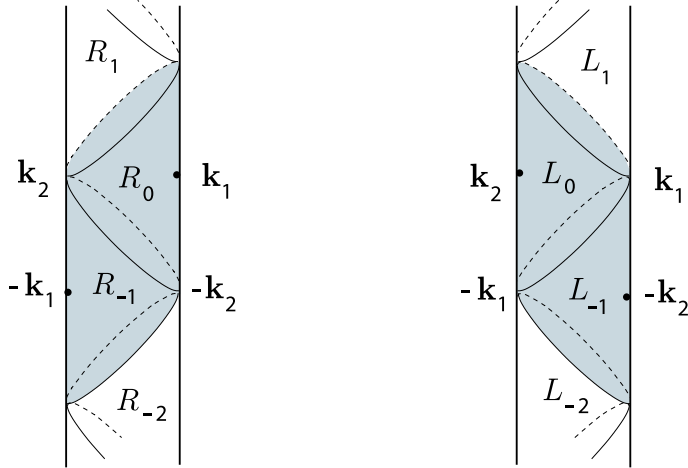

Figure 6: The momenta  $\mathbf{k}_1, \mathbf{k}_2$  divide AdS space in Poincaré patches  $L_n$  and  $R_n$ . The boundary wave functions  $\phi_1$  and  $\phi_3$  ( $\phi_2$  and  $\phi_4$ ) are localized on the boundary of  $R_{-1}$  and  $R_0$  ( $L_{-1}$  and  $L_0$ ).

where <sup>4</sup>

$$\mathcal{C}_\Delta = \frac{1}{2\pi^{\frac{d}{2}}} \frac{\Gamma(\Delta)}{\Gamma(\Delta - \frac{d}{2} + 1)}.$$

In particular, if  $n(\mathbf{p}, \mathbf{x}) = 0, \pm 1$ , then

$$K_\Delta(\mathbf{p}, \mathbf{x}) = \frac{\mathcal{C}_\Delta}{(-2\mathbf{p} \cdot \mathbf{x} + i\epsilon)^\Delta}.$$

Recall that the momenta  $\mathbf{k}_1$  and  $\mathbf{k}_2$  indicate, respectively, the outgoing directions of particles 1 and 2, whereas  $-\mathbf{k}_1$  and  $-\mathbf{k}_2$  indicate the incoming ones. These null vectors are identified with boundary points as in Figure 6. We therefore expect the boundary wave functions to be localized around these points. Implicit in the discussion in the previous sections is the assumption that  $n(\mathbf{k}_1, \mathbf{k}_2) = n(-\mathbf{k}_1, -\mathbf{k}_2) = 0$ , whereas  $n(\mathbf{k}_2, -\mathbf{k}_1) = n(\mathbf{k}_1, -\mathbf{k}_2) = 1$ . The momentum  $\mathbf{k}_1$  divides global  $\text{AdS}_{d+1}$  space into a set of Poincaré patches  $L_n$  of points  $\mathbf{x}$  such that  $n(\mathbf{x}, \mathbf{k}_1) = n$ , which are separated by the surface  $\mathbf{x} \cdot \mathbf{k}_1 = 0$ , as shown explicitly in Figure 6. Similarly, we have the patches  $R_n$  of points  $\mathbf{x}$  with  $n(\mathbf{x}, \mathbf{k}_2) = n$ , separated by the surface  $\mathbf{x} \cdot \mathbf{k}_2 = 0$ . A point  $\mathbf{x}$ , either in AdS or on its boundary, with  $\mathbf{x} \cdot \mathbf{k}_1 < 0$  ( $\mathbf{x} \cdot \mathbf{k}_1 > 0$ ) will be within a region  $L_n$  with  $n$  even (odd), and similarly for the regions  $R_n$ . From our previous construction, we see that the interaction takes place around the hyperboloid  $H_{d-1}$  defined by the intersection of the boundary between  $R_0$  and  $R_{-1}$  ( $\mathbf{x} \cdot \mathbf{k}_2 = 0$ ) and the boundary between  $L_0$  and  $L_{-1}$  ( $\mathbf{x} \cdot \mathbf{k}_1 = 0$ ). Let us then consider the incoming wave  $\phi_1(\mathbf{p}_1)$ . In order to achieve the required eikonal kinematics, we shall localize  $\phi_1$  on the boundary of  $R_{-1}$ , around the point  $-\mathbf{k}_1$ .

<sup>4</sup>The normalization  $\mathcal{C}_\Delta$  is not the standard one used in the literature [7, 5]. In this paper, the boundary propagator  $K_\Delta(\mathbf{p}, \mathbf{p}')$  and the bulk to boundary propagator  $K_\Delta(\mathbf{p}, \mathbf{x})$  are taken to be the limit of the bulk to bulk propagator  $\Pi_\Delta(\mathbf{x}', \mathbf{x})$  as the bulk points approach the boundary. As shown in [15, 16], naive Feynman graphs in AdS computed with this prescription give correctly normalized CFT correlators, including the subtle two-point function.

We shall show in the next section that, if we choose only positive frequency modes with respect to the action of time translation in this patch, which is generated by  $\mathbf{T}_2$ , the corresponding bulk wave function  $\psi_1$  will have support only on patches  $R_n$  with  $n \geq -1$ . Similarly, we shall localize  $\phi_3$  on  $\partial R_0$ , around the point  $\mathbf{k}_1$ , with negative frequency modes only, so that  $\psi_3$  will have support on  $R_n$  for  $n \leq 0$ . The overlap of  $\psi_1$  and  $\psi_3$  will then be non vanishing only in regions  $R_{-1}$  and  $R_0$ , which are those parametrized explicitly by the coordinates  $\{u, v, \mathbf{w}\}$ . In a symmetric way, we shall localize  $\phi_2$  ( $\phi_4$ ) on  $\partial L_{-1}$  ( $\partial L_0$ ), around the point  $-\mathbf{k}_2$  ( $\mathbf{k}_2$ ), with positive (negative) frequency modes with respect to  $\mathbf{T}_1$ . The overlap of  $\psi_2$  and  $\psi_4$  is then localized in regions  $L_{-1}$  and  $L_0$ , parametrized by  $\{\bar{u}, \bar{v}, \bar{\mathbf{w}}\}$ . Summarizing, the relevant choice of kinematics for the four points  $\mathbf{p}_i$  ( $i = 1, \dots, 4$ ) is given by

$$\begin{aligned}
\mathbf{p}_1 \sim -\mathbf{k}_1 &\Rightarrow \mathbf{p}_1 \in \partial R_{-1} && (\mathbf{p}_1 \cdot \mathbf{k}_2 > 0) , \\
\mathbf{p}_2 \sim -\mathbf{k}_2 &\Rightarrow \mathbf{p}_3 \in \partial R_0 && (\mathbf{p}_3 \cdot \mathbf{k}_2 < 0) , \\
\mathbf{p}_3 \sim \mathbf{k}_1 &\Rightarrow \mathbf{p}_2 \in \partial L_{-1} && (\mathbf{p}_2 \cdot \mathbf{k}_1 > 0) , \\
\mathbf{p}_4 \sim \mathbf{k}_2 &\Rightarrow \mathbf{p}_4 \in \partial L_0 && (\mathbf{p}_4 \cdot \mathbf{k}_1 < 0) ,
\end{aligned} \tag{26}$$

so that

$$\begin{aligned}
n(\mathbf{p}_1, \mathbf{p}_2) &= n(\mathbf{p}_3, \mathbf{p}_4) = 0 , \\
n(\mathbf{p}_4, \mathbf{p}_1) &= n(\mathbf{p}_3, \mathbf{p}_2) = 1 .
\end{aligned}$$

We shall choose, once and for all, a specific normalization of the  $\mathbf{p}_i$  by rescaling the external points, so that

$$2\mathbf{p}_1 \cdot \mathbf{k}_2 = -2\mathbf{p}_3 \cdot \mathbf{k}_2 = 2\mathbf{p}_2 \cdot \mathbf{k}_1 = -2\mathbf{p}_4 \cdot \mathbf{k}_1 = (2\omega)^2 .$$

It is also convenient to parametrize the  $\mathbf{p}_i$  in terms of Poincaré coordinates. Using the explicit coordinates on  $\mathbb{R}^{2,d} \simeq \mathbb{M}^2 \times \mathbb{M}^d$  introduced in section 3.1, we write

$$\begin{aligned}
\mathbf{p}_1 &= 2\omega \left( p_1^2, 1, p_1 \right) , && \mathbf{p}_2 = 2\omega \left( 1, p_2^2, p_2 \right) , \\
\mathbf{p}_3 &= -2\omega \left( p_3^2, 1, p_3 \right) , && \mathbf{p}_4 = -2\omega \left( 1, p_4^2, p_4 \right) ,
\end{aligned} \tag{27}$$

with the Poincaré positions  $p_i \in \mathbb{M}^d$  small, i.e. in components  $|p_i^a| \ll 1$ .

We shall denote the corresponding CFT amplitude, computed with this kinematics, by

$$\hat{A}(\mathbf{p}_1, \dots, \mathbf{p}_4) = K_{\Delta_1}(\mathbf{p}_1, \mathbf{p}_3) K_{\Delta_2}(\mathbf{p}_2, \mathbf{p}_4) \hat{\mathcal{A}}(z, \bar{z}) , \tag{28}$$

where the cross ratios are small and satisfy

$$z\bar{z} \simeq p^2 \bar{p}^2 , \quad z + \bar{z} \simeq 2p \cdot \bar{p} , \tag{29}$$

with

$$p = p_3 - p_1 , \quad \bar{p} = p_2 - p_4 .$$

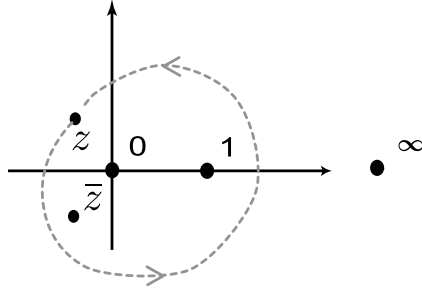

Figure 7: Analytic continuation necessary to obtain  $\hat{\mathcal{A}}$  from the Euclidean amplitude  $\mathcal{A}$ .

We shall reserve the label  $A$  and  $\mathcal{A}$  for the amplitude computed on the principal Euclidean sheet, where  $n(\mathbf{p}_i, \mathbf{p}_j) = 0$ . As we shall discuss in detail in section 4.3, the amplitude  $\hat{\mathcal{A}}(z, \bar{z})$  is related to  $\mathcal{A}(z, \bar{z})$  by analytic continuation. More precisely, we shall show that

$$\hat{\mathcal{A}}(z, \bar{z}) = \mathcal{A}^\circ(z, \bar{z}) , \quad (30)$$

where the right-hand side indicates the function obtained by keeping  $\bar{z}$  fixed and rotating  $z$  counter-clockwise around the branch points 0 and 1, as shown in Figure 7.

Let us now discuss the boundary propagators  $K_\Delta$  in (28). The only subtle issue comes from the appropriate phase factors [1]. More precisely, given the choices in (26) and the form of the boundary propagator in (25), we have that  $K_{\Delta_1}(\mathbf{p}_1, \mathbf{p}_3)$  is given by  $\mathcal{C}_{\Delta_1} |2\mathbf{p}_1 \cdot \mathbf{p}_3|^{-\Delta_1}$  times the following phases

1	$\mathbf{p}_1, \mathbf{p}_3$ spacelike separated	
$i^{-2\Delta_1}$	$\mathbf{p}_3$ in the future of $\mathbf{p}_1$ with $\mathbf{p}_1 \cdot \mathbf{p}_3 > 0$	(31)
$i^{-4\Delta_1}$	$\mathbf{p}_3$ in the future of $\mathbf{p}_1$ with $\mathbf{p}_1 \cdot \mathbf{p}_3 < 0$	

A similar statement applies to the propagator  $K_{\Delta_2}(\mathbf{p}_2, \mathbf{p}_4)$ . The amplitude (28) is then given, in terms of  $p, \bar{p}$  by

$$\hat{A}(p, \bar{p}) = \frac{(2\omega i)^{-2\Delta_1} \mathcal{C}_{\Delta_1}}{(p^2 + i\epsilon_p)^{\Delta_1}} \frac{(2\omega i)^{-2\Delta_2} \mathcal{C}_{\Delta_2}}{(\bar{p}^2 - i\epsilon_{\bar{p}})^{\Delta_2}} \hat{\mathcal{A}}(z, \bar{z}) , \quad (32)$$

where we have explicitly written the two propagators using

$$\epsilon_p = \epsilon \operatorname{sign}(-x_0 \cdot p) ,$$

which picks the correct branch of the logarithm consistent with the phase prescription in (31). Notice that  $x_0$  is any future directed vector in  $\mathbb{M}^d$ , which we choose to be the reference point introduced in (14) of section 3.

## 4.2 Boundary Wave Functions

We shall now describe in detail a particularly convenient choice of boundary wave functions, consistent with the general description of the previous section, and which correspond to bulk

wave functions of the eikonal type. First recall that in section 3.1,  $\mathbf{k}_1$  defined a surface in AdS containing the null geodesics that go from the boundary point  $-\mathbf{k}_1$  to  $\mathbf{k}_1$ . We have then used the AdS isometry generated by  $\mathbf{T}_2$  to build the congruence of null geodesics associated to particle 1. This isometry is time translation in the Poincaré patch  $R_{-1}$ , with boundary centered at  $-\mathbf{k}_1$ . It is then natural to localize the boundary wave function of  $\mathcal{O}_1$  along the timelike line

$$\mathbf{p}_1(t) = -e^{t\mathbf{T}_2} \mathbf{k}_1 = -\mathbf{k}_1 + t\omega \mathbf{x}_0 + \frac{t^2}{4} \mathbf{k}_2 .$$

In fact, parametrizing  $\mathbf{p}_1(t)$  in Poincaré coordinates as in (27), we have that

$$p_1(t) = \frac{t}{2} x_0 ,$$

so, as a function of  $t$ , we are moving in the future time direction indicated by  $x_0$ . We then modulate the boundary function with  $\omega F(t) e^{-i\omega t}$ , where the function  $F$  is the profile function introduced in (20). The bulk wave function  $\psi_1$  is then given by

$$\psi_1(\mathbf{x}) = \omega \int dt F(t) e^{-i\omega t} \frac{\mathcal{C}_{\Delta_1}}{(-2\mathbf{p}_1(t) \cdot \mathbf{x} + i\epsilon)^{\Delta_1}} ,$$

where the  $i\epsilon$  prescription is correct for all points  $\mathbf{x}$  in region  $R_{-1}$ . Since  $F(t)$  is non-vanishing only for  $|t| < \Lambda$ , the above description is valid also in part of region  $R_0$ , as we shall show shortly. In the coordinate system (10), valid in  $R_{-1}$  and  $R_0$ , we have

$$-2\mathbf{p}_1(t) \cdot \mathbf{x} = -2\omega(t - v) \left( 1 + \frac{u}{4}(t - v) \right) (\mathbf{x}_0 \cdot \mathbf{w}) ,$$

showing that the integrand diverges for  $t = v$  and  $t = v - 4/u$ . The first divergence corresponds to the future directed signal from point  $\mathbf{p}_1(t)$ , whereas the second divergence comes from the reflection at the AdS boundary for  $u > 0$  and from the backward signal from  $\mathbf{p}_1(t)$  for  $u < 0$ . The backwards signal is relevant in region  $R_{-1}$ , where the  $i\epsilon$  prescription is valid. For positive  $\omega$  one may close the  $t$  contour avoiding completely the singularity from the backwards signal, showing that positive frequencies propagate forward in global time. In region  $R_0$ , on the other hand, the  $i\epsilon$  prescription is valid up to the reflected signal at the second singularity, more precisely for  $u\Lambda < |4 - vu|$ . In this part of  $R_0$  and in region  $R_{-1}$ , for large  $\omega$ , the integral is dominated by the divergence at  $t = v$ , and we have that

$$\psi_1(\mathbf{x}) \simeq \omega F(v) \int dt e^{-i\omega t} \frac{\mathcal{C}_{\Delta_1}}{(-2\omega(t - v)(\mathbf{x}_0 \cdot \mathbf{w}) + i\epsilon)^{\Delta_1}} .$$

It is then clear that, for large  $\omega$ , the wave function  $\psi_1$  has precisely the required form

$$\psi_1(\mathbf{x}) \simeq e^{-i\omega v} F(v) F_1(\mathbf{w}) ,$$

with

$$F_1(\mathbf{w}) = i^{-\Delta_1} \frac{2\pi \mathcal{C}_{\Delta_1}}{\Gamma(\Delta_1)} (-2\mathbf{x}_0 \cdot \mathbf{w})^{-\Delta_1} .$$

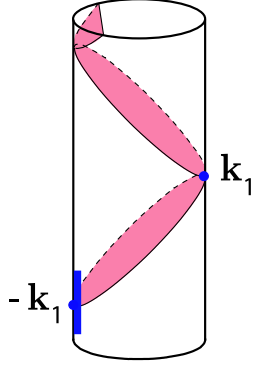

Figure 8: The boundary wave function  $\phi_1$  is localized along a small timelike segment centered in  $-\mathbf{k}_1$ . The bulk wave function  $\psi_1$  is mainly supported around the region  $\mathbf{k}_1 \cdot \mathbf{x} = 0$  in the future of the boundary point  $-\mathbf{k}_1$ .

Thus, the wave function  $\psi_1$  is supported mainly around the future directed null geodesics starting from the point  $-\mathbf{k}_1$  of the boundary, as depicted in Figure 8. Similarly, we choose the boundary wave function of  $\mathcal{O}_2$  localized along the timelike line

$$\mathbf{p}_2(t) = -e^{t\mathbf{T}_1} \mathbf{k}_2 = -\mathbf{k}_2 + t\omega \mathbf{x}_0 + \frac{t^2}{4} \mathbf{k}_1 ,$$

which means

$$p_2(t) = \frac{t}{2} x_0 .$$

The bulk wave function  $\psi_2$  has then the required eikonal form in (20) with

$$F_2(\bar{\mathbf{w}}) = i^{-\Delta_2} \frac{2\pi \mathcal{C}_{\Delta_2}}{\Gamma(\Delta_2)} (-2\mathbf{x}_0 \cdot \bar{\mathbf{w}})^{-\Delta_2} .$$

The boundary wave functions  $\phi_3$  and  $\phi_4$  will be the complex conjugates of  $\phi_1$  and  $\phi_2$ , but localized along slightly different curves,

$$\mathbf{p}_3(t) = e^{t\mathbf{T}_2} (\mathbf{k}_1 + \mathbf{q}) , \quad \mathbf{p}_4(t) = e^{t\mathbf{T}_1} (\mathbf{k}_2 + \bar{\mathbf{q}}) .$$

In analogy with flat space, the eikonal regime corresponds to  $\mathbf{q}^2, \bar{\mathbf{q}}^2 \ll \omega^2$ . The fact that  $\mathbf{p}_3$  and  $\mathbf{p}_4$  must be null vectors yields the conditions

$$\mathbf{q}^2 = -2\mathbf{k}_1 \cdot \mathbf{q} , \quad \bar{\mathbf{q}}^2 = -2\mathbf{k}_2 \cdot \bar{\mathbf{q}} .$$

The parts of  $\mathbf{q}$  and  $\bar{\mathbf{q}}$  that are, respectively, proportional to  $\mathbf{k}_1$  and  $\mathbf{k}_2$  are irrelevant since we stay in the same null rays. This freedom can be used to fix

$$\mathbf{k}_2 \cdot \mathbf{q} = 0 , \quad \mathbf{k}_1 \cdot \bar{\mathbf{q}} = 0 .$$

Furthermore, we shall choose  $\mathbf{q}$  and  $\bar{\mathbf{q}}$  orthogonal to  $\mathbf{x}_0$ . In the explicit coordinates for  $\mathbb{M}^2 \times \mathbb{M}^d$  we have

$$\mathbf{q} = 2\omega (q^2, 0, q) , \quad \bar{\mathbf{q}} = 2\omega (0, \bar{q}^2, \bar{q}) ,$$



with  $q \cdot x_0 = \bar{q} \cdot x_0 = 0$ , so that

$$p_3(t) = \frac{t}{2} x_0 - q, \quad p_4(t) = \frac{t}{2} x_0 - \bar{q}.$$

We then have that

$$\begin{aligned} \mathbf{p}_3(t) \cdot \mathbf{x} &= -\mathbf{p}_1(t) \cdot \mathbf{x} + \mathbf{q} \cdot \mathbf{w} + \frac{u}{4\omega} (\mathbf{x}_0 \cdot \mathbf{w}) \mathbf{q}^2, \\ \mathbf{p}_4(t) \cdot \bar{\mathbf{x}} &= -\mathbf{p}_2(t) \cdot \bar{\mathbf{x}} + \bar{\mathbf{q}} \cdot \bar{\mathbf{w}} + \frac{\bar{v}}{4\omega} (\mathbf{x}_0 \cdot \bar{\mathbf{w}}) \bar{\mathbf{q}}^2. \end{aligned}$$

At large  $\omega$ , the leading contribution to the bulk wave function  $\psi_3$  is given by

$$\begin{aligned} \psi_3(\mathbf{x}) &= \omega \int dt F^*(t) e^{i\omega t} \frac{\mathcal{C}_{\Delta_1}}{(-2\mathbf{p}_3(t) \cdot \mathbf{x} + i\epsilon)^{\Delta_1}} \\ &\simeq e^{i\omega v} F^*(v) F_3(\mathbf{w}), \end{aligned}$$

where the transverse modulation function  $F_3(\mathbf{w})$  is

$$\begin{aligned} F_3(\mathbf{w}) &= \mathcal{C}_{\Delta_1} \int dl e^{il} (2(\mathbf{x}_0 \cdot \mathbf{w})l - 2\mathbf{q} \cdot \mathbf{w} + i\epsilon)^{-\Delta_1} \\ &= i^{-\Delta_1} \frac{2\pi \mathcal{C}_{\Delta_1}}{\Gamma(\Delta_1)} (-2\mathbf{x}_0 \cdot \mathbf{w})^{-\Delta_1} \exp\left(i \frac{\mathbf{q} \cdot \mathbf{w}}{\mathbf{x}_0 \cdot \mathbf{w}}\right). \end{aligned}$$

Similarly,  $\psi_4$  has the form in (20) with

$$F_4(\bar{\mathbf{w}}) = i^{-\Delta_2} \frac{2\pi \mathcal{C}_{\Delta_2}}{\Gamma(\Delta_2)} (-2\mathbf{x}_0 \cdot \bar{\mathbf{w}})^{-\Delta_2} \exp\left(i \frac{\bar{\mathbf{q}} \cdot \bar{\mathbf{w}}}{\mathbf{x}_0 \cdot \bar{\mathbf{w}}}\right).$$

With the specific choice of wave functions just described, the AdS eikonal amplitude (22) becomes

$$\begin{aligned} A_{eik} &\simeq 2i^{-2\Delta_1} i^{-2\Delta_2} \left( \frac{8\pi^2 \omega \mathcal{C}_{\Delta_1} \mathcal{C}_{\Delta_2}}{\Gamma(\Delta_1) \Gamma(\Delta_2)} \right)^2 \int_{H_{d-1}} d\mathbf{w} d\bar{\mathbf{w}} (-2\mathbf{x}_0 \cdot \mathbf{w})^{-2\Delta_1} (-2\mathbf{x}_0 \cdot \bar{\mathbf{w}})^{-2\Delta_2} \\ &\exp\left( i \frac{\mathbf{q} \cdot \mathbf{w}}{\mathbf{x}_0 \cdot \mathbf{w}} + i \frac{\bar{\mathbf{q}} \cdot \bar{\mathbf{w}}}{\mathbf{x}_0 \cdot \bar{\mathbf{w}}} + \frac{ig^2}{2} (2\omega)^{2j-2} \frac{\Pi_{\perp}(\mathbf{w}, \bar{\mathbf{w}})}{((\mathbf{x}_0 \cdot \mathbf{w})(\mathbf{x}_0 \cdot \bar{\mathbf{w}}))^{j-1}} \right). \end{aligned} \quad (33)$$

By construction, the above expression should approximate, in the limit of large  $\omega$ , the CFT correlator  $\hat{A}(p, \bar{p})$  in (32) integrated against the corresponding boundary wave-functions  $\phi_i(\mathbf{p}_i)$ ,

$$A_{eik} \simeq \omega^4 \int dt_1 \cdots dt_4 F(t_1) F(t_2) F^*(t_3) F^*(t_4) e^{i\omega(t_3-t_1)+i\omega(t_4-t_2)} \hat{A}(p(t_i), \bar{p}(t_i)), \quad (34)$$

with

$$p(t_i) = \frac{t_3 - t_1}{2} x_0 - q, \quad \bar{p}(t_i) = \frac{t_2 - t_4}{2} x_0 + \bar{q}.$$

Before deriving the consequences of this result, we must clarify the structure of the four point correlator  $\hat{A}$  in (34). We shall devote the next three sections to this purpose and return to equations (33) and (34) only in section 4.6.

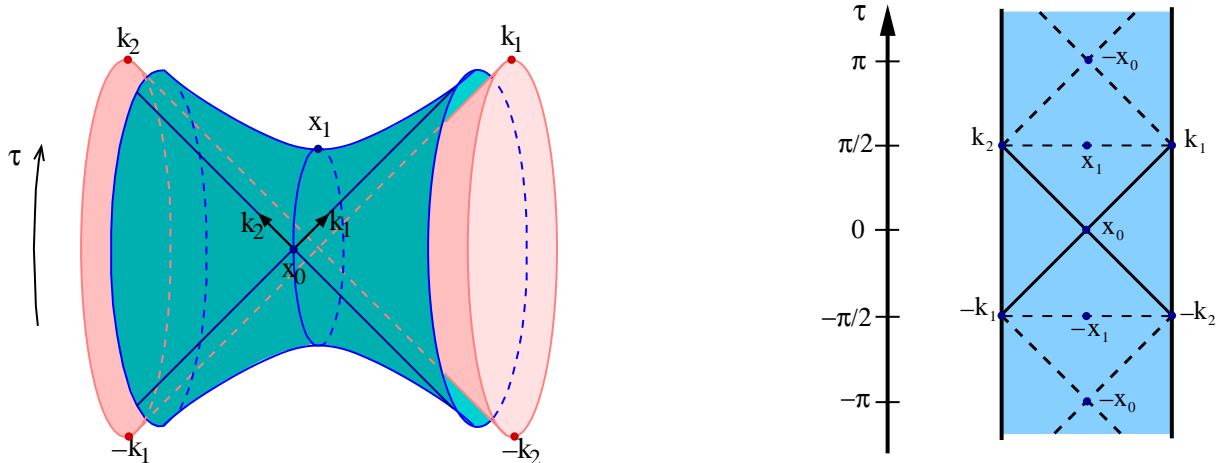

Figure 9: Unwrapping the AdS<sub>2</sub> global time circle.

### 4.3 Analytic Continuation

Let us discuss the issue of analytic continuation of the amplitude  $A(\mathbf{p}_i)$ , showing in particular how to derive (30). First note that the cross ratios  $z, \bar{z}$  as defined in (24) are invariant under rescalings  $\mathbf{p}_i \rightarrow \lambda_i \mathbf{p}_i$ , with  $\lambda_i$  arbitrary and, in particular, negative. Moreover, two different boundary points differing by a  $2\pi$  translation in AdS global time have the same embedding representation and therefore also give rise to the same values of  $z, \bar{z}$ . On the other hand, in global AdS, different sets of boundary points  $\mathbf{p}_i$  with the same values of  $z, \bar{z}$  have, in general, different reduced amplitudes  $\mathcal{A}(z, \bar{z})$  related by analytic continuation. More precisely, the amplitude  $\mathcal{A}$  is a multi-valued function of  $z, \bar{z}$  with branch points at  $z, \bar{z} = 0, 1, \infty$ , and different sets  $\{\mathbf{p}_i\}$  with the same cross ratios correspond, in general, to different sheets. The best way to understand this is to start from the Euclidean reduced four-point amplitude  $\mathcal{A}(z, \bar{z})$  and then Wick rotate to the Lorentzian setting.

We start by choosing a global time  $\tau$  in AdS. From the embedding space perspective, global time translations are rotations in a timelike plane. We choose this to be the plane generated by the normalized timelike vectors  $\mathbf{x}_0$  and  $\mathbf{x}_1$ , with  $2\omega \mathbf{x}_1 = \mathbf{k}_1 + \mathbf{k}_2$  (see Figure 9). A generic boundary point  $\mathbf{p}$  can then be written as

$$\mathbf{p} = \lambda \left[ \cos(\tau) \mathbf{x}_0 + \sin(\tau) \mathbf{x}_1 + \mathbf{n} \right],$$

where the vector  $\mathbf{n}$  belongs to the  $(d-1)$ -dimensional unit sphere embedded in the space  $\mathbb{R}^d$  orthogonal to  $\mathbf{x}_0$  and  $\mathbf{x}_1$ , and the constant  $\lambda > 0$  depends on the choice of representative  $\mathbf{p}$  for each null ray. We can then consider, for each of the boundary points under consideration, the standard Wick rotation  $\tau \rightarrow -i\tau$  parametrized by  $0 \leq \theta \leq 1$ ,

$$\mathbf{p} = \lambda \left[ \cos \left( -i\tau e^{\frac{i\pi}{2}\theta} \right) \mathbf{x}_0 + \sin \left( -i\tau e^{\frac{i\pi}{2}\theta} \right) \mathbf{x}_1 + \mathbf{n} \right],$$

where  $\theta = 0$  corresponds to the Euclidean setting and  $\theta = 1$  to the Minkowski one. Given the coordinates  $\tau_i$  and  $\mathbf{n}_i$  of the four boundary points  $\mathbf{p}_i$ , the corresponding variables  $z(\theta), \bar{z}(\theta)$

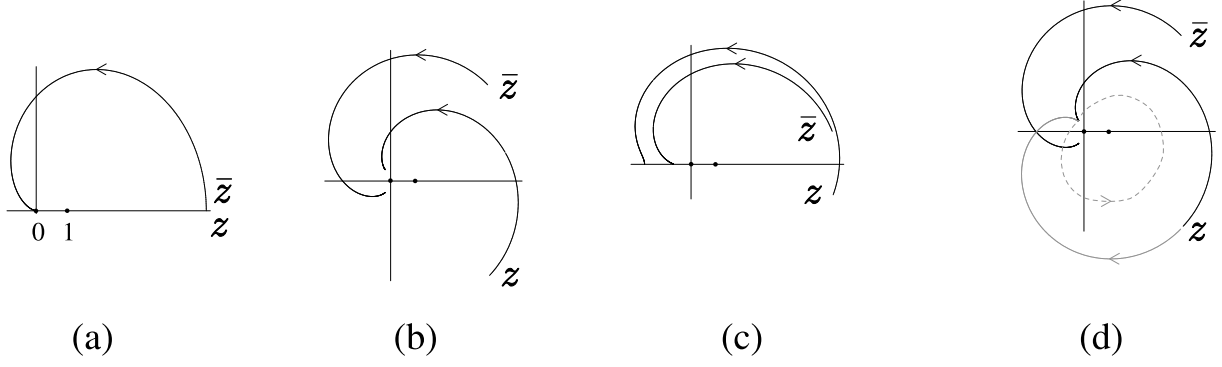

Figure 10: Figures (a), (b) and (c) show the curves  $z(\theta)$  and  $\bar{z}(\theta)$  starting from the Euclidean setting at  $\theta = 0$ , with  $z(0) = \bar{z}^*(0)$ . Plot (a) corresponds to the limiting path  $z(\theta) = \bar{z}(\theta)$  where  $t_i = 0$  and  $\mathbf{q} = \bar{\mathbf{q}} = 0$ . Plots (b) and (c) correspond to general paths. Figure (d) shows the relevant analytic continuation relating  $\hat{\mathcal{A}}$  to  $\mathcal{A}$ . Starting from path (b), the curve  $z(\theta)$ , shown in black, is equivalent to the path shown in gray, which, in turn, is composed of two parts. The continuous part, which is the complex conjugate of the curve  $\bar{z}(\theta)$ , computes  $\mathcal{A}$  on the principal sheet. The dashed part, also shown in Figure 7, rotates  $z$  counter-clockwise around the singularities at 0 and 1. Therefore  $\hat{\mathcal{A}} = \mathcal{A}^\circ$ .

define two paths in the complex plane parametrized by  $0 \leq \theta \leq 1$ . The paths  $z(\theta)$ ,  $\bar{z}(\theta)$  are explicitly obtained by replacing

$$\mathbf{p}_i \cdot \mathbf{p}_j \rightarrow \mathbf{n}_i \cdot \mathbf{n}_j - \cos \left( -i(\tau_i - \tau_j) e^{\frac{i\pi}{2}\theta} \right) ,$$

in the expressions (24). The Lorentzian amplitude  $\hat{\mathcal{A}}$  is then given by the analytic continuation of the basic Euclidean amplitude  $\mathcal{A}$  following the paths  $z(\theta)$ ,  $\bar{z}(\theta)$  from  $\theta = 0$  to  $\theta = 1$ .

In our particular case, we have

$$\begin{aligned} \tau_1 &\simeq -\frac{\pi}{2} + t_1 , & \mathbf{n}_1 &\simeq \frac{1}{2\omega} (\mathbf{k}_2 - \mathbf{k}_1) , \\ \tau_2 &\simeq -\frac{\pi}{2} + t_2 , & \mathbf{n}_2 &\simeq \frac{1}{2\omega} (\mathbf{k}_1 - \mathbf{k}_2) , \\ \tau_3 &\simeq \frac{\pi}{2} + t_3 , & \mathbf{n}_3 &\simeq \frac{1}{2\omega} \left( \mathbf{k}_1 - \mathbf{k}_2 + 2\mathbf{q} + \frac{\mathbf{q}^2}{2\omega^2} \mathbf{k}_2 \right) , \\ \tau_4 &\simeq \frac{\pi}{2} + t_4 , & \mathbf{n}_4 &\simeq \frac{1}{2\omega} \left( \mathbf{k}_2 - \mathbf{k}_1 + 2\bar{\mathbf{q}} + \frac{\bar{\mathbf{q}}^2}{2\omega^2} \mathbf{k}_1 \right) , \end{aligned}$$

in the relevant regime of  $t_i \ll 1$  and  $\mathbf{q}^2, \bar{\mathbf{q}}^2 \ll \omega^2$ . Therefore, the complex paths  $z(\theta)$ ,  $\bar{z}(\theta)$  will be small deformations of the paths

$$z(\theta) = \bar{z}(\theta) = \cos^2 \left( i e^{\frac{i\pi}{2}\theta} \pi/2 \right)$$

obtained in the special case  $t_i = 0$  and  $\mathbf{q} = \bar{\mathbf{q}} = 0$ . This limiting path is plotted in Figure 10a. We also show, in Figures 10b and 10c two generic paths, respectively with Lorentzian values

$\bar{z}(1) = z^*(1)$  and  $\text{Im } z(1) = \text{Im } \bar{z}(1) = 0$ . The equations governing the generic paths are rather cumbersome and are not important for our present purpose. At this point we notice that the paths  $z(\theta)$  in Figures 10b and 10c can be continuously deformed, without crossing any branch point, to the path complex conjugate to  $\bar{z}(\theta)$ , plus a full counter-clockwise turn around 0 and 1, as shown in Figure 10d. Thus, the Lorentzian amplitude  $\hat{\mathcal{A}}(z, \bar{z})$  is obtained from the basic Euclidean amplitude  $\mathcal{A}(z, \bar{z})$  after transporting  $z$  anti-clockwise around 0 and 1 keeping  $\bar{z}$  fixed,

$$\hat{\mathcal{A}}(z, \bar{z}) = \mathcal{A}^\circ(z, \bar{z}) .$$

## 4.4 Anomalous Dimensions as Phase Shift

As explained in sections 4.1 and 4.2, the AdS eikonal regime probes the Lorentzian amplitude  $\hat{\mathcal{A}}$  for small values of the cross ratios  $z, \bar{z}$ . Here we shall relate the behavior of  $\hat{\mathcal{A}}$  in this regime to the anomalous dimensions of the composite primary operators <sup>5</sup>,

$$\mathcal{O}_1 \partial_{\mu_1} \cdots \partial_{\mu_J} \partial^{2n} \mathcal{O}_2 ,$$

of large dimension  $E = \Delta_1 + \Delta_2 + J + 2n$  and large spin  $J$ . We shall also use the conformal dimensions  $h \geq \bar{h} \geq 0$  defined by

$$E = h + \bar{h} , \quad J = h - \bar{h} .$$

Consider the expansion of the Euclidean amplitude  $\mathcal{A}$  in  $S$ -channel conformal partial waves, corresponding to the OPE at  $z, \bar{z} \rightarrow \infty$  (or  $\mathbf{p}_1 \rightarrow \mathbf{p}_2$ ). Following [2], we shall assume that the  $S$ -channel decomposition of the Euclidean amplitude  $\mathcal{A}$  at large  $h, \bar{h}$  is dominated by the  $\mathcal{O}_1 \mathcal{O}_2$  composites. Denoting their anomalous dimensions by  $2\Gamma(h, \bar{h})$ , we can write

$$\mathcal{A}(z, \bar{z}) \simeq \sum_{h \geq \bar{h}} (1 + R(h, \bar{h})) \mathcal{S}_{h+\Gamma(h, \bar{h}), \bar{h}+\Gamma(h, \bar{h})}(z, \bar{z}) , \quad (35)$$

where  $\mathcal{S}_{h, \bar{h}}$  are the partial waves corresponding to the  $S$ -channel exchange of a primary field with conformal dimensions  $h, \bar{h}$ . The coefficient  $R(h, \bar{h})$  encodes the three point coupling between  $\mathcal{O}_1, \mathcal{O}_2$  and the exchanged composite primary field. The sum is over the lattice

$$h, \bar{h} \in \frac{\Delta_1 + \Delta_2}{2} + \mathbb{N}_0 , \quad \frac{\Delta_1 + \Delta_2}{2} \leq \bar{h} \leq h .$$

In [2] we introduced an impact parameter representation  $\mathcal{I}_{h, \bar{h}}$  for the  $S$ -channel partial waves  $\mathcal{S}_{h, \bar{h}}$ , which approximates the latter for small  $z, \bar{z}$ . Moreover, we showed that in the regime of small  $z, \bar{z}$  one can replace the sum over  $S$ -channel partial waves in (35) by an integral over their impact parameter representation,

$$\mathcal{A}(z, \bar{z}) \simeq \int dh d\bar{h} (1 + R(h, \bar{h})) \mathcal{I}_{h+\Gamma(h, \bar{h}), \bar{h}+\Gamma(h, \bar{h})}(z, \bar{z}) .$$

---

<sup>5</sup>We will use this schematic notation to represent the primary composite operators of spin  $J$  and conformal dimension  $E$ , avoiding the rather cumbersome exact expression.

Expanding in powers of  $\Gamma$  and dropping the explicit reference to  $h, \bar{h}$ , this equation reads

$$\begin{aligned} \mathcal{A}(z, \bar{z}) &\simeq \int dh d\bar{h} (1 + R) \left( 1 + \Gamma \partial + \frac{1}{2} \Gamma^2 \partial^2 + \frac{1}{3!} \Gamma^3 \partial^3 + \dots \right) \mathcal{I}_{h, \bar{h}}(z, \bar{z}) \\ &\simeq \int dh d\bar{h} \left[ 1 - (\partial \Gamma - R) + \partial(\Gamma(\partial \Gamma - R)) - \frac{1}{2} \partial^2 (\Gamma^2(\partial \Gamma - R)) + \dots \right] \mathcal{I}_{h, \bar{h}}(z, \bar{z}) , \end{aligned}$$

where  $\partial$  denotes  $\partial_h + \partial_{\bar{h}}$  and in the second equation we have integrated by parts inside the integral over conformal weights  $h, \bar{h}$ . On one hand, the standard OPE guarantees that the Euclidean amplitude  $\mathcal{A}$  is regular for small values of  $z, \bar{z}$ . As shown in [2], this implies that the coefficients of the above S-channel partial wave expansion vanish for large  $h, \bar{h}$ . On the other hand, the coefficients  $R$  and the anomalous dimensions  $\Gamma$  are computed in perturbation theory with a leading contribution at order  $g^2$ . Therefore, the consecutive terms in the last expression have increasing leading order in the coupling  $g^2$  and can not cancel among themselves. We then conclude that <sup>6</sup>

$$R \simeq \partial \Gamma ,$$

to all orders in the coupling  $g^2$ .

In order to explore the consequences of the results of the previous sections, we must analytically continue equation (35) to find the partial wave expansion of the Lorentzian amplitude  $\hat{\mathcal{A}} = \mathcal{A}^\circ$ . Using the perturbative form,

$$\mathcal{A}(z, \bar{z}) \simeq \sum (1 + \partial \Gamma) \left( 1 + \Gamma \partial + \frac{1}{2} \Gamma^2 \partial^2 + \frac{1}{3!} \Gamma^3 \partial^3 + \dots \right) \mathcal{S}_{h, \bar{h}}(z, \bar{z}) ,$$

of equation (35), we just need to compute the analytic continuation

$$[(\partial_h + \partial_{\bar{h}})^n \mathcal{S}_{h, \bar{h}}(z, \bar{z})]^\circ .$$

This can be easily determined using the OPE expansion

$$\mathcal{S}_{h, \bar{h}}(z, \bar{z}) = z^{\frac{\Delta_1 + \Delta_2}{2} - h} \bar{z}^{\frac{\Delta_1 + \Delta_2}{2} - \bar{h}} \sum_{n, \bar{n} \geq 0} z^{-n} \bar{z}^{-\bar{n}} c_{n, \bar{n}}(h, \bar{h}) + (z \leftrightarrow \bar{z}) ,$$

of the S-channel partial waves around  $z, \bar{z} \sim \infty$  (see [2]). The differential operator

$$\tilde{\partial} = z^{-h} \bar{z}^{-\bar{h}} \partial z^h \bar{z}^{\bar{h}} = \partial + \ln(z\bar{z}) ,$$

acting on  $\mathcal{S}_{h, \bar{h}}$  for  $h, \bar{h} \in (\Delta_1 + \Delta_2)/2 + \mathbb{N}_0$ , is invariant under the analytic continuation  $\circ$ . Therefore,

$$\begin{aligned} [\partial^n \mathcal{S}]^\circ &= \left[ \left( \tilde{\partial} - \ln(z\bar{z}) \right)^n \mathcal{S} \right]^\circ \\ &= \left( \tilde{\partial} - \ln(e^{2\pi i} z\bar{z}) \right)^n \mathcal{S} \\ &= (\partial - 2\pi i)^n \mathcal{S} . \end{aligned}$$

---

<sup>6</sup>More precisely,  $R - \partial \Gamma$  has to go to zero, for  $h, \bar{h} \rightarrow \infty$ , at least as fast as  $(h\bar{h})^{(2-d)/2}$ , which corresponds to the exchange of the state of lowest dimension allowed by the unitarity bound.

The Lorentzian amplitude  $\hat{\mathcal{A}} = \mathcal{A}^\odot$  is then given by

$$\hat{\mathcal{A}}(z, \bar{z}) \simeq \sum (1 + \partial\Gamma) \left( 1 + \Gamma(\partial - 2\pi i) + \frac{1}{2}\Gamma^2(\partial - 2\pi i)^2 + \frac{1}{3!}\Gamma^3(\partial - 2\pi i)^3 + \dots \right) \mathcal{S}_{h, \bar{h}}(z, \bar{z}) .$$

Focusing in the small  $z, \bar{z}$  regime we can write

$$\hat{\mathcal{A}}(z, \bar{z}) \simeq \int dh d\bar{h} \left( 1 - 2\pi i\Gamma + \frac{2\pi i}{2}(2\pi i + \partial)\Gamma^2 - \frac{2\pi i}{3!}(2\pi i + \partial)^2\Gamma^3 + \dots \right) \mathcal{I}_{h, \bar{h}}(z, \bar{z}) ,$$

where we have integrated by parts inside the integral over conformal dimensions  $h, \bar{h}$ . In the large  $h, \bar{h}$  limit we can neglect the derivative  $\partial = \partial_h + \partial_{\bar{h}}$  with respect to the constant  $2\pi i$ , obtaining

$$\hat{\mathcal{A}}(z, \bar{z}) \simeq \int dh d\bar{h} e^{-2\pi i\Gamma(h, \bar{h})} \mathcal{I}_{h, \bar{h}}(z, \bar{z}) . \quad (36)$$

Hence, in the impact parameter representation of the reduced Lorentzian amplitude  $\hat{\mathcal{A}}$ , the anomalous dimensions  $2\Gamma$  play the role of a phase shift.

## 4.5 Impact Parameter Representation

Now we wish to find an explicit form of the impact parameter representation for the Lorentzian amplitude  $\hat{\mathcal{A}}$  in (32). First we recall a basic result derived in [2]. For  $p, \bar{p}$  in the past Milne wedge  $-M$ , the impact parameter partial wave  $\mathcal{I}_{h, \bar{h}}$  admits the integral representation <sup>7</sup> over the future Milne wedge  $M$

$$\begin{aligned} \mathcal{I}_{h, \bar{h}} = & \mathcal{N}_{\Delta_1} \mathcal{N}_{\Delta_2} (-p^2)^{\Delta_1} (-\bar{p}^2)^{\Delta_2} \int_M \frac{dx}{|x|^{d-2\Delta_1}} \frac{d\bar{x}}{|\bar{x}|^{d-2\Delta_2}} e^{-2p \cdot x - 2\bar{p} \cdot \bar{x}} \\ & 4h\bar{h} \delta(2x \cdot \bar{x} + h^2 + \bar{h}^2) \delta(x^2 \bar{x}^2 - h^2 \bar{h}^2) , \end{aligned}$$

where the cross ratios  $z, \bar{z}$  are related to  $p, \bar{p}$  as in (29) and the constant  $\mathcal{N}_\Delta$  is given by

$$\mathcal{N}_\Delta = \frac{2\pi^{1-\frac{d}{2}}}{\Gamma(\Delta) \Gamma(1 + \Delta - \frac{d}{2})} = \frac{4\pi \mathcal{C}_\Delta}{\Gamma(\Delta)^2} .$$

Expression (36) for the reduced amplitude becomes then

$$\hat{\mathcal{A}} \simeq \mathcal{N}_{\Delta_1} \mathcal{N}_{\Delta_2} (-p^2)^{\Delta_1} (-\bar{p}^2)^{\Delta_2} \int_M \frac{dx}{|x|^{d-2\Delta_1}} \frac{d\bar{x}}{|\bar{x}|^{d-2\Delta_2}} e^{-2p \cdot x - 2\bar{p} \cdot \bar{x}} e^{-2\pi i\Gamma(h, \bar{h})} , \quad (37)$$

where  $\Gamma(h, \bar{h})$  depends on  $x, \bar{x}$  through

$$h^2 \bar{h}^2 = x^2 \bar{x}^2 , \quad h^2 + \bar{h}^2 = -2x \cdot \bar{x} . \quad (38)$$

---

<sup>7</sup> The impact parameter representation derived in this section is valid in general for  $p = p_3$  and  $\bar{p} = p_2$ , with  $p_1 = p_4 = 0$ . The general case is then related by a conformal transformation, whose precise form is rather cumbersome, but reduces to  $p \simeq p_3 - p_1$  and  $\bar{p} \simeq p_2 - p_4$  for the case of interest  $|p_i^a| \ll 1$ .

The fact that  $\hat{\mathcal{A}}$  is uniquely a function of the cross-ratios  $z, \bar{z}$ , translates into the fact that the phase shift  $\Gamma$  depends only on  $x^2 \bar{x}^2$  and  $-2x \cdot \bar{x}$ .

To write the impact parameter representation for the full Lorentzian amplitude  $\hat{A}$ , consider first the boundary propagators in (32). For  $p, \bar{p}$  in the past Milne wedge  $-M$  we have

$$(p^2 + i\epsilon_p)^{-\Delta_1} = i^{2\Delta_1} (-p^2)^{-\Delta_1} , \quad (\bar{p}^2 - i\epsilon_{\bar{p}})^{-\Delta_2} = i^{-2\Delta_2} (-\bar{p}^2)^{-\Delta_2} ,$$

where we recall that  $\epsilon_p = \epsilon \text{sign}(-x_0 \cdot p)$  with  $x_0 \in M$ . Rotating the radial part of the  $x, \bar{x}$  integrals over the Milne wedges in (37), so that  $x \rightarrow ix$  and  $\bar{x} \rightarrow -i\bar{x}$ , (32) becomes

$$\hat{A}(p, \bar{p}) \simeq (2\omega i)^{-2\Delta_1 - 2\Delta_2} \mathcal{C}_{\Delta_1} \mathcal{C}_{\Delta_2} \mathcal{N}_{\Delta_1} \mathcal{N}_{\Delta_2} \int_M \frac{dx}{|x|^{d-2\Delta_1}} \frac{d\bar{x}}{|\bar{x}|^{d-2\Delta_2}} e^{2ip \cdot x - 2i\bar{p} \cdot \bar{x}} e^{-2\pi i \Gamma(h, \bar{h})} . \quad (39)$$

Although this representation was derived assuming  $p, \bar{p}$  in the past Milne wedge we claim it is valid for generic  $p, \bar{p} \in \mathbb{M}^d$ . In fact, for the  $\Gamma = 0$  non-interacting amplitude, we recover the boundary propagators from the Fourier transform (which we recall in appendix B)

$$\mathcal{N}_{\Delta} \int_M \frac{dx}{|x|^{d-2\Delta}} e^{\pm 2ip \cdot x} = \frac{1}{(p^2 \pm i\epsilon_p)^{\Delta}} . \quad (40)$$

## 4.6 Anomalous Dimensions of Double Trace Operators

We are now in position to use the AdS/CFT prediction given by equations (33) and (34) to determine the phase shift in the impact parameter representation (39) and therefore to compute the anomalous dimension of double trace primary operators. First replace (39) in (34)

$$\begin{aligned} A_{eik} &\simeq \omega^4 (2\omega i)^{-2\Delta_1 - 2\Delta_2} \mathcal{C}_{\Delta_1} \mathcal{C}_{\Delta_2} \mathcal{N}_{\Delta_1} \mathcal{N}_{\Delta_2} \\ &\int dt_1 \cdots dt_4 F(t_1) F(t_2) F^*(t_3) F^*(t_4) e^{i\omega(t_3 - t_1) + i\omega(t_4 - t_2)} \\ &\int_M \frac{dx}{|x|^{d-2\Delta_1}} \frac{d\bar{x}}{|\bar{x}|^{d-2\Delta_2}} e^{i(t_3 - t_1)x_0 \cdot x + i(t_4 - t_2)x_0 \cdot \bar{x} - 2iq \cdot x - 2i\bar{q} \cdot \bar{x}} e^{-2\pi i \Gamma(h, \bar{h})} . \end{aligned}$$

At high energy  $\omega$ , we have  $t_1 \sim t_3$  and  $t_2 \sim t_4$ . Hence, the integrals over the time sums  $\frac{1}{2} \int d(t_1 + t_3) F(t_1) F^*(t_3)$  and  $\frac{1}{2} \int d(t_2 + t_4) F(t_2) F^*(t_4)$  give an overall factor of 2 from the normalization (21). We are then left with the integrals over the differences, which give

$$(2\pi)^2 \delta(x_0 \cdot x + \omega) \delta(x_0 \cdot \bar{x} + \omega) .$$

It is easy to see that the integral in  $x$  in the future Milne wedge  $M$  at fixed time component  $x_0 \cdot x$  is equivalent to the integral over points  $w$  in the hyperboloid  $H_{d-1}$ , with the change of coordinates

$$\begin{aligned} x &= -\frac{\omega}{x_0 \cdot w} w , \\ \int_M dx \delta(x_0 \cdot x + \omega) &= 2^d \omega^{d-1} \int_{H_{d-1}} \frac{dw}{(-2x_0 \cdot w)^d} . \end{aligned}$$

We then get

$$A_{eik} \simeq 2(2\pi\omega)^2 i^{-2\Delta_1-2\Delta_2} \mathcal{C}_{\Delta_1} \mathcal{C}_{\Delta_2} \mathcal{N}_{\Delta_1} \mathcal{N}_{\Delta_2} \int_{H_{d-1}} \frac{d\mathbf{w}}{(-2x_0 \cdot \mathbf{w})^{2\Delta_1}} \frac{d\bar{\mathbf{w}}}{(-2x_0 \cdot \bar{\mathbf{w}})^{2\Delta_2}} \exp\left(2i\omega \frac{\mathbf{q} \cdot \mathbf{w}}{x_0 \cdot \mathbf{w}} + 2i\omega \frac{\bar{\mathbf{q}} \cdot \bar{\mathbf{w}}}{x_0 \cdot \bar{\mathbf{w}}} - 2\pi i \Gamma(h, \bar{h})\right), \quad (41)$$

where  $\Gamma(h, \bar{h})$  depends on  $\mathbf{w}, \bar{\mathbf{w}}$  through

$$4h\bar{h} = \frac{(2\omega)^2}{(x_0 \cdot \mathbf{w})(x_0 \cdot \bar{\mathbf{w}})}, \quad \frac{\bar{h}}{h} + \frac{h}{\bar{h}} = -2\mathbf{w} \cdot \bar{\mathbf{w}}.$$

We conclude that a double trace primary operator with large  $h, \bar{h}$  can be described in AdS by two particles approximately following two null geodesics as in Figure 1, with impact parameter  $r = \log(h/\bar{h})$  and momenta  $\mathbf{k}$  and  $\bar{\mathbf{k}}$  satisfying  $s = -2\mathbf{k} \cdot \bar{\mathbf{k}} = 4h\bar{h}$ .

Finally, reverting equation (41) to the embedding space notation, by replacing  $\mathbf{w}, \bar{\mathbf{w}}, x_0, 2\omega\mathbf{q}, 2\omega\bar{\mathbf{q}}$  with  $\mathbf{w}, \bar{\mathbf{w}}, \mathbf{x}_0, \mathbf{q}, \bar{\mathbf{q}}$ , we recover (33), with a prediction for the large  $h, \bar{h}$  behavior of the anomalous dimensions due to the AdS exchange of a spin  $j$  particle of dimension  $\Delta$ ,

$$2\Gamma(h, \bar{h}) \simeq -\frac{g^2}{2\pi} (4h\bar{h})^{j-1} \Pi_{\perp}(h/\bar{h}).$$

The transverse propagator  $\Pi_{\perp}$  is the Euclidean scalar propagator on  $H_{d-1}$  with dimension  $\Delta-1$ . Its explicit form in terms of the hypergeometric function is

$$\begin{aligned} \Pi_{\perp}(h, \bar{h}) &= \frac{1}{2\pi^{\frac{d}{2}-1}} \frac{\Gamma(\Delta-1)}{\Gamma(\Delta-\frac{d}{2}+1)} \left(\frac{(h-\bar{h})^2}{h\bar{h}}\right)^{1-\Delta} \\ &F\left(\Delta-1, \frac{2\Delta-d+1}{2}, 2\Delta-d+1, -\frac{4h\bar{h}}{(h-\bar{h})^2}\right). \end{aligned}$$

In particular, in dimensions  $d=2$  and  $d=4$  the above expression simplifies to

$$\begin{aligned} \Pi_{\perp}(h, \bar{h}) &= \frac{1}{2(\Delta-1)} \left(\frac{h}{\bar{h}}\right)^{1-\Delta} & (d=2), \\ &= \frac{1}{2\pi} \frac{h^2}{h^2-\bar{h}^2} \left(\frac{h}{\bar{h}}\right)^{1-\Delta} & (d=4). \end{aligned}$$

The anomalous dimensions just obtained are exactly the same<sup>8</sup> we obtained in [2], where we only considered tree level interactions based on a shock wave computation in AdS [1]. In other words, the loop corrections to the anomalous dimensions of primary operators with large  $h, \bar{h}$  are subleading with respect to the tree level contribution. This is reminiscent of the flat space statement that the loop corrections to the phase shift of large spin partial waves are subleading with respect to the tree level contribution. We must therefore retract the conjecture we put forward in [2], which included contributions from all orders in perturbation theory to the anomalous dimensions in the large  $h, \bar{h}$  limit.

<sup>8</sup>In [1, 2] a different convention for the coupling constant  $g_{\text{here}}^2 = 4^{3-j} 2\pi G_{\text{there}}$  was used.



We emphasize that, for large  $h, \bar{h}$ , the anomalous dimensions are dominated by the AdS particles with highest spin. Moreover, when  $h \gg \bar{h}$  the lightest particle of maximal spin determines  $\Gamma$ , since in this limit the propagator  $\Pi_{\perp} \sim (h/\bar{h})^{1-\Delta}$ . In theories with a gravitational description, this particle is *the graviton*. This yields a universal prediction for CFT's with AdS duals in the gravity limit

$$2\Gamma(h, \bar{h}) \simeq -16Gh\bar{h} \Pi_{\perp}(h/\bar{h}) \quad (h \sim \bar{h} \rightarrow \infty, \quad h \gg \bar{h}, \quad \Delta = d) \quad , \quad (42)$$

where  $\Pi_{\perp}$  is the Euclidean scalar propagator in  $H_{d-1}$  with mass squared  $d-1$ .

Recall [2] that the impact parameter distance  $r$  is given by  $r = \ell \ln(h/\bar{h})$ . Keeping in mind the canonical example of the duality between strings on  $\text{AdS}_5 \times S^5$  and  $\mathcal{N} = 4$  SYM theory, we expect (42) to be valid for large  $r \gg \ell$ . Corrections to (42), due to massive KK modes of the graviton, will start to be relevant at  $r \sim \ell$ . These corrections are computable with an extension of the methods of this paper, which includes the sphere  $S^5$  in the transverse space. More complex, as in flat space, are the corrections due to string effects [17, 18]. As in flat space, particles of all spins are exchanged, resulting in an effective reggeon interaction of spin approximately 2 for large string tension. As recalled in [18], in flat space the leading corrections to the pure gravity result occur due to tidal forces which excite internal modes of the scattering strings. These effects start to be relevant at impact parameters of the order of  $\ell_{\text{Planck}} (\mathcal{E} \ell_s)^{2/(d-1)}$ , where  $\ell_{\text{Planck}}$  is Planck length in the  $(d+1)$ -dimensional spacetime, and where  $\mathcal{E}$  is the energy of the process. Translating into  $\text{AdS}_5$  variables, we then expect tidal string excitations to play a role at  $r \lesssim G^{1/3} \ell^{1/3} \ell_s^{2/3} (h\bar{h})^{1/3}$ , i. e. at  $\ln(h/\bar{h}) \lesssim (h\bar{h})^{1/3} N^{-2/3} \lambda^{-1/6}$ , where  $\lambda = (\ell/\ell_s)^4$  is the 't Hooft coupling of the YM theory. We shall discuss these effects extensively in a forthcoming publication [10].

## 5 Future Work

In this paper we have derived the eikonal approximation for high energy interactions in Anti-de Sitter spacetime. We have been working uniquely in the supergravity approximation, but we plan to extend these results by including string effects [10]. Discussing, for concreteness, the duality between strings on  $\text{AdS}_5 \times S^5$  and  $\mathcal{N} = 4$  SYM theory, we shall address the following issues

- At large 't Hooft coupling  $\lambda = (\ell/\ell_s)^4$ , the leading correction to graviton exchange will come from the contributions of the leading Regge trajectory. The effective spin  $j$  of the exchanged particle will now depend on the transverse momentum transfer. This requires an extension of Regge theory to conformal field theories which is quite natural in our formalism, with results which reproduce and extend those of [19].
- At weak coupling  $\lambda$ , high energy interactions are dominated by Pomeron exchange. Following the initial results of [19], we shall relate our formalism to that of BFKL [20, 21, 22],

describing hard pomeron exchange at weak coupling, including the non-trivial transverse dependence relevant at non-vanishing momentum transfer.

- The relation of phase shift and anomalous dimension suggests an extension of the results of this paper to the weak coupling  $\lambda \rightarrow 0$  regime, following the ideas of Amati, Ciafaloni and Veneziano [17] on high energy string scattering. The phase shift  $\Gamma$  will become an operator acting on two-string states, which will include both an orbital part as well as a contribution from the internal excitation of the two scattering strings. A natural candidate for  $\Gamma$  will be a generalization, to double trace operators, of the dilatation operator [23] which has played a crucial role in analyzing the spectrum of single trace states in  $\mathcal{N} = 4$  SYM theory.

## Acknowledgments

We would like to thank N. Gromov, J. Maldacena, G. Veneziano and P. Vieira for discussions and comments. Our research is supported in part by INFN, by the MIUR-COFIN contract 2003-023852, by the EU contracts MRTN-CT-2004-503369, MRTN-CT-2004-512194, by the INTAS contract 03-51-6346, by the NATO grant PST.CLG.978785 and by the FCT contract POCI/FP/63904/2005. LC is supported by the MIUR contract “Rientro dei cervelli” part VII. JP is funded by the FCT fellowship SFRH/BD/9248/2002. *Centro de Física do Porto* is partially funded by FCT through the POCTI program. MC and LC have been partially supported by the Galileo Institute for Theoretical Physics, during the program *String and M theory approaches to particle physics and cosmology*, where part of this work was completed.

## A General Spin $j$ Interaction

We wish to extend to result  $G(\mathbf{w} \cdot \bar{\mathbf{w}}) = \Pi_{\perp}(\mathbf{k}, \bar{\mathbf{k}})$ , derived in section 3.3, to the case of general  $j$ . To this end we use equation (16), contracting both sides with

$$(-2)^j \mathbf{k}_{\alpha_1} \cdots \mathbf{k}_{\alpha_j} \bar{\mathbf{k}}_{\beta_1} \cdots \bar{\mathbf{k}}_{\beta_j}$$

and integrating against

$$\int_{-\infty}^{\infty} dud\bar{v} = \frac{(2\omega)^2}{(\mathbf{x}_0 \cdot \mathbf{w})^2 (\bar{\mathbf{x}}_0 \cdot \bar{\mathbf{w}})^2} \int_{-\infty}^{\infty} d\lambda d\bar{\lambda} .$$

Using the explicit form of the  $\delta$ -function in the  $\{u, v, \mathbf{w}\}$  coordinate system give in section 3.3, the RHS reduces to

$$2i (2\omega)^{2j} \frac{(1 + v\bar{u}/4)^{2j-2}}{(\mathbf{x}_0 \cdot \mathbf{w})^{2j+2}} \delta_{H_{d-1}}(\mathbf{w}, \bar{\mathbf{w}}) . \quad (43)$$

Next we consider the LHS of (16). First we note that the non-vanishing components of the covariant derivatives of  $\mathbf{k}$  are given by

$$\nabla_v \mathbf{k}_v = -\frac{\omega u}{2} , \quad \nabla_v \mathbf{k}_\chi = \nabla_\chi \mathbf{k}_v = \frac{\omega}{\chi} ,$$

where we explicitly parametrize the metric on  $H_{d-1}$  as in section 3.3. Using these facts, together with the explicit form of the metric and with

$$\square_{\text{AdS}} \mathbf{k}_\alpha = -d \cdot \mathbf{k}_\alpha , \quad \nabla_\gamma \mathbf{k}_\alpha , \nabla^\gamma \mathbf{k}_\beta = \frac{\chi^2 - 1}{\chi^2} \mathbf{k}_\alpha \mathbf{k}_\beta ,$$

we conclude, after a tedious but straightforward computation, that

$$\begin{aligned} & (-2)^j \mathbf{k}_{\alpha_1} \cdots \mathbf{k}_{\alpha_j} \bar{\mathbf{k}}_{\beta_1} \cdots \bar{\mathbf{k}}_{\beta_j} \square_{\text{AdS}} \Pi_{\Delta}^{\alpha_1, \dots, \alpha_j, \beta_1, \dots, \beta_j} = \\ & = \square_{\text{AdS}} \Pi_{\Delta}^{(j)} + j \left[ 2 \frac{\chi^2 - 1}{\chi} \partial_\chi + (d + j - 1) - \frac{j + 1}{\chi^2} \right] \Pi_{\Delta}^{(j)} + \partial_u(\dots) \\ & = \left[ \square_{H_{d-1}} + 2(j + 1) \frac{\chi^2 - 1}{\chi} \partial_\chi + j(d + j - 1) - \frac{j(j + 1)}{\chi^2} \right] \Pi_{\Delta}^{(j)} + \partial_u(\dots) , \end{aligned}$$

where we do not show the explicit terms of the form  $\partial_u(\dots)$  since they will vanish once integrated along the two geodesics. Note that the terms in  $\dots$  contain also other components of the spin- $j$  propagator aside from  $\Pi_{\Delta}^{(j)}$ . We conclude that (43) must be equated to

$$-2i (2\omega)^{2j} \left( 1 + \frac{v\bar{u}}{4} \right)^{2j-2} \left[ \square_{H_{d-1}} - (\Delta + j)(\Delta - d - j) + 2(j + 1) \frac{\chi^2 - 1}{\chi} \partial_\chi - \frac{j(j + 1)}{\chi^2} \right] \frac{G(\mathbf{w}, \bar{\mathbf{w}})}{(\chi\bar{\chi})^{j+1}} .$$

Using the fact that

$$[\square_{H_{d-1}}, \chi^{-1-j}] = \frac{j + 1}{\chi^{1+j}} \left( -2 \frac{\chi^2 - 1}{\chi} \partial_\chi + (j - d + 3) - \frac{j + 2}{\chi^2} \right) ,$$

we deduce again that

$$[\square_{H_{d-1}} + 1 - d - \Delta(\Delta - d)] G(\mathbf{w} \cdot \bar{\mathbf{w}}) = -\delta(\mathbf{w}, \bar{\mathbf{w}}) .$$

and therefore the function  $G$  is given by  $\Pi_{\perp}$ .

## B Some Relevant Fourier Transforms

Start by recalling the standard generalized Feynman propagator

$$\frac{1}{\pi^d} \int_{\mathbb{M}^d} \frac{dp}{(p^2 \mp i\epsilon)^\Delta} e^{2ix \cdot p} = \pm \frac{\pi^{-\frac{d}{2}} \Gamma\left(\frac{d}{2} - \Delta\right)}{\Gamma(\Delta)} \frac{i}{(x^2 \pm i\epsilon)^{\frac{d}{2} - \Delta}}.$$

We now wish to consider the Fourier transform of interest

$$f(x) = \frac{1}{\pi^d} \int_{\mathbb{M}^d} \frac{dp}{(p^2 - i\epsilon_p)^\Delta} e^{2ix \cdot p}$$

We consider first the case  $x^0 = -x \cdot x_0 < 0$ . In this case  $f(x)$  vanishes since we can deform the  $p^0$  contour in the upper complex plane  $\text{Im } p^0 > 0$ . By Lorentz invariance,  $f(x)$  also vanishes whenever  $x$  is spacelike, and  $f(x)$  is therefore supported only in the future Milne wedge  $M$ , where it is proportional to  $|x|^{2\Delta-d}$ . To find the constant of proportionality, we note that, when  $x^0 > 0$  we may deform the  $p^0$  contours in the lower complex plane and show that

$$f(x) = \frac{1}{\pi^d} \int_{\mathbb{M}^d} \left[ \frac{dp}{(p^2 + i\epsilon)^\Delta} + \frac{dp}{(p^2 - i\epsilon)^\Delta} \right] e^{2ix \cdot p}. \quad (x^0 > 0)$$

We then deduce that

$$\begin{aligned} f(x) &= -i \frac{\pi^{-\frac{d}{2}} \Gamma\left(\frac{d}{2} - \Delta\right)}{\Gamma(\Delta)} (i^{2\Delta} - i^{-2\Delta}) |x|^{2\Delta-d} \\ &= \frac{2\pi^{1-\frac{d}{2}}}{\Gamma(\Delta) \Gamma\left(1 + \Delta - \frac{d}{2}\right)} |x|^{2\Delta-d} \quad (x \in M) \end{aligned}$$

and  $f(x) = 0$  for  $x \notin M$ , thus proving equation (40).

## References

- [1] L. Cornalba, M. S. Costa, J. Penedones and R. Schiappa, *Eikonal approximation in AdS/CFT: From shock waves to four-point functions*, [arXiv:hep-th/0611122].
- [2] L. Cornalba, M. S. Costa, J. Penedones and R. Schiappa, *Eikonal Approximation in AdS/CFT: Conformal Partial-Waves and Finite N Four-Point Functions*, [arXiv:hep-th/0611123].
- [3] J. M. Maldacena, *The Large N Limit of Superconformal Field Theories and Supergravity*, Adv. Theor. Math. Phys. **2** (1998) 231, [arXiv:hep-th/9711200].
- [4] S. S. Gubser, I. R. Klebanov and A. M. Polyakov, *Gauge Theory Correlators from Non-Critical String Theory*, Phys. Lett. **B428** (1998) 105, [arXiv:hep-th/9802109].
- [5] E. Witten, *Anti-de Sitter Space and Holography*, Adv. Theor. Math. Phys. **2** (1998) 253, [arXiv:hep-th/9802150].
- [6] O. Aharony, S. S. Gubser, J. M. Maldacena, H. Ooguri and Y. Oz, *Large N Field Theories, String Theory and Gravity*, Phys. Rept. **323** (2000) 183, [arXiv:hep-th/9905111].
- [7] E. D'Hoker and D. Z. Freedman, *Supersymmetric Gauge Theories and the AdS/CFT Correspondence*, [arXiv:hep-th/0201253].
- [8] M. Levy and J. Sucher, *Eikonal Approximation in Quantum Field Theory*, Phys. Rev. **186** (1969) 1656.
- [9] G. 't Hooft, *Graviton Dominance in Ultrahigh-Energy Scattering*, Phys. Lett. **B198** (1987) 61.
- [10] L. Cornalba, M. S. Costa, J. Penedones, *To appear*.
- [11] E. Eichten and R. Jackiw, *Failure of the eikonal approximation for the vertex function in a boson field theory*, Phys. Rev. D **4**, 439 (1971).
- [12] D. Kabat and M. Ortiz, *Eikonal Quantum Gravity and Planckian Scattering*, Nucl. Phys. **B388** (1992) 570, [arXiv:hep-th/9203082].  
D. Kabat, *Validity of the Eikonal approximation*, Comments Nucl. Part. Phys. **20**, 325 (1992) [arXiv:hep-th/9204103].
- [13] F. A. Dolan and H. Osborn, *Conformal Partial Waves and the Operator Product Expansion*, Nucl. Phys. **B678** (2004) 491, [arXiv:hep-th/0309180].
- [14] F. A. Dolan and H. Osborn, *Conformal Four-Point Functions and the Operator Product Expansion*, Nucl. Phys. **B599** (2001) 459, [arXiv:hep-th/0011040].

- [15] D. Z. Freedman, S. D. Mathur, A. Matusis and L. Rastelli, *Correlation Functions in the  $CFT_d/AdS_{d+1}$  Correspondence*, Nucl. Phys. **B546** (1999) 96, [arXiv:hep-th/9804058].
- [16] I. R. Klebanov and E. Witten, *AdS/CFT Correspondence and Symmetry Breaking*, Nucl. Phys. **B556** (1999) 89, [arXiv:hep-th/9905104].
- [17] D. Amati, M. Ciafaloni and G. Veneziano, *Superstring Collisions at Planckian Energies*, Phys. Lett. **B197** (1987) 81.
- [18] S. B. Giddings, D. J. Gross and A. Maharana, *Gravitational effects in ultrahigh-energy string scattering*, arXiv:0705.1816 [hep-th].
- [19] R. C. Brower, J. Polchinski, M. J. Strassler and C. I. Tan, *The Pomeron and Gauge/String Duality*, [arXiv:hep-th/0603115].  
J. Polchinski and M. J. Strassler, *Hard Scattering and Gauge/String Duality*, Phys. Rev. Lett. **88** (2002) 031601, [arXiv:hep-th/0109174].
- [20] M. T. Grisaru, H. J. Schnitzer and H. S. Tsao, *Reggeization of elementary particles in renormalizable gauge theories - vectors and spinors*, Phys. Rev. D **8** (1973) 4498.  
L. N. Lipatov, *Reggeization of the Vector Meson and the Vacuum Singularity in Nonabelian Gauge Theories*, Sov. J. Nucl. Phys. **23** (1976) 642–656  
V. S. Fadin, E. A. Kuraev and L. N. Lipatov, *On The Pomeron Singularity In Asymptotically Free Theories*, Phys. Lett. **B60** (1975) 50–52  
E. A. Kuraev, L. N. Lipatov and V. S. Fadin, *Multi-Reggeon Processes in the Yang-Mills Theory*, Sov. Phys. JETP **44** (1976) 443–450  
E. A. Kuraev, L. N. Lipatov and V. S. Fadin, *The Pomeron Singularity in Nonabelian Gauge Theories*, Sov. Phys. JETP **45** (1977) 199–204  
Ya. Ya. Balitsky and L. N. Lipatov, *The Pomeron Singularity in Quantum Chromodynamics*, Sov. J. Nucl. Phys. **28** (1978) 822–829.
- [21] L. N. Lipatov, *The Bare Pomeron In Quantum Chromodynamics*, Sov. Phys. JETP **63**, 904 (1986) [Zh. Eksp. Teor. Fiz. **90**, 1536 (1986)].
- [22] L. N. Lipatov, *Small- $x$  physics in perturbative QCD*, Phys. Rept. **286**, 131 (1997) [arXiv:hep-ph/9610276].
- [23] N. Beisert, *The dilatation operator of  $N = 4$  super Yang-Mills theory and integrability*, Phys. Rept. **405**, 1 (2005) [arXiv:hep-th/0407277].