

EtabFDC: an η_b event generator in hadroproduction at LHC

Cong-Feng Qiao^{a,c}, Jian Wang^a, Jian Xiong Wang^b,
Yangheng Zheng^a

^a*Graduate University of Chinese Academy of Sciences, Beijing, 100049, China*

^b*Institute of High Energy Physics, CAS, Beijing 100049, China*

^c*Theoretical Physics Center for Science Facilities, CAS, Beijing 100049, China*

Abstract

The EtabFDC is a matrix-element event generator package for η_b hadroproduction at LHC. It generates $pp \rightarrow \eta_b X$ events for all possible parton-level $2 \rightarrow 2$ leading-order processes with three commonly used η_b decay channels being implemented. The PYTHIA interface is used for parton-shower and hadronization to obtain the hadronic events. The FORTRAN codes of this package are generated by FDC (Feynman Diagram Calculation) system automatically.

Key words: Event generator, FDC, Etab

PACS: 02.70-c, 11.55.Hx

Program summary

Program Title: EtabFDC (Version 1.01)

Keywords: Event generator, FDC, Etab

PACS: 02.70-c; 11.55.Hx

Operating system: Linux (with GNU FORTRAN 77 compiler)

Programming language: FORTRAN 77

External libraries: CERNLIB 2001 (or CERNLIB 2003)

Distribution format: tar gzip file

Size of the compressed distribution file: 17.1M Bytes.

Classification: 11.1

Nature of physical problem: This package generates $pp \rightarrow \eta_b X$ events for partonic $2 \rightarrow 2$ tree-level processes with implementing three η_b decay channels. It then interfaces with PYTHIA for parton-shower and hadronization to obtain the hadronic events.

Method of solution: The FORTRAN codes of this package are generated by FDC system[10] automatically.

Typical running time: To generate 1,000 events on a 3.2G Intel-P4 CPU platform (with hyper-technology), it will take approximate 20, 30 and 300 seconds for decay channel $\eta_b \rightarrow J/\psi\gamma$, $\eta_b \rightarrow J/\psi J/\psi$ and $\eta_b \rightarrow J/\psi c\bar{c}$ respectively.

1 Introduction

As the $b\bar{b}$ ground state, η_b has been a focus in high energy physics since it had not been found experimentally for more than thirty years. Many theoretical models[1,2,3,4,5,6,7,8,9] estimated the properties of η_b . The commissioning LHC experiments will provide a excellent opportunity to search for the signal of η_b . Thus, an event generator software, that simulates the η_b production and decays, is necessary to understand the reconstructed signal and backgrounds in the pp collision environment. In this work, we just present such a package, named EtabFDC, that can generate $pp \rightarrow \eta_b X$ events from leading-order (LO) processes (Fig. 4 and Fig. 5) at parton-level. Here, the total cross-section of the η_b production is calculated to be $9.3 \times 10^7 \text{ Pb}$. Three η_b decay modes, that may be reconstructed by the LHC experiments, are included in this package. They are: $\eta_b \rightarrow J/\psi\gamma$ [12], $\eta_b \rightarrow J/\psi J/\psi$ and $\eta_b \rightarrow J/\psi c\bar{c}$ [13]. If the branching-ratio is provided, we can estimate the number of produced η_b events of a specific decay channel in LHC for a given luminosity. For example, the theoretical prediction of the branching-ratio of channel $\eta_b \rightarrow J/\psi J/\psi$ is 5×10^{-8} . And considering the 1 fb^{-1} data collected by the LHC detector in the first year, the number of $\eta_b \rightarrow J/\psi J/\psi$ events produced is about 4650. Under current software framework, more decay channels can be added as the independent modules by the future demand.

Feynman Diagram Calculation package (FDC) [10,11] is one of the projects which aimed at calculationg Feynman diagram automatically. It can conveniently implement physical models from the first principle, then construct

their *Lagrangians*, deduce the Feynman rules and generate FORTRAN codes for calculations of physical quantities such as decay width, cross-section and matrix-element. EtabFDC is a FDC application and its FORTRAN codes for the calculation of the η_b production processes are generated by FDC automatically. And the three decay modes of η_b are added by manual work. In this way, many careless errors can be systematically checked and debugged. EtabFDC has interface with PYTHIA to generating the hadronic events.

As a test, we plot the 2-initial-partons' centre of mass (c.m.) energy (Fig. 1) and the transverse-momentum p_t (Fig. 2) distributions with generating 20-million η_b events. Here, we put the pp collisions energy at $\sqrt{s} = 14$ TeV. And the η_b mass value is set to be 9.3 GeV. In Fig. 1, the peak at 9.3 GeV corresponds to the $g + g \rightarrow \eta_b$ process, where the c.m. energy of the two initial gluons has to be equal to the mass of η_b . Please also note that, in Fig. 2, a bump around 3 GeV is produced for the fragmentation processes. The cross-section shortfall below 3 GeV is caused by a transverse-momentum cut, $p_t > 3$ GeV, on the fragmented parton b or g , which then form the η_b . We obtained the expected results from the simulation output.

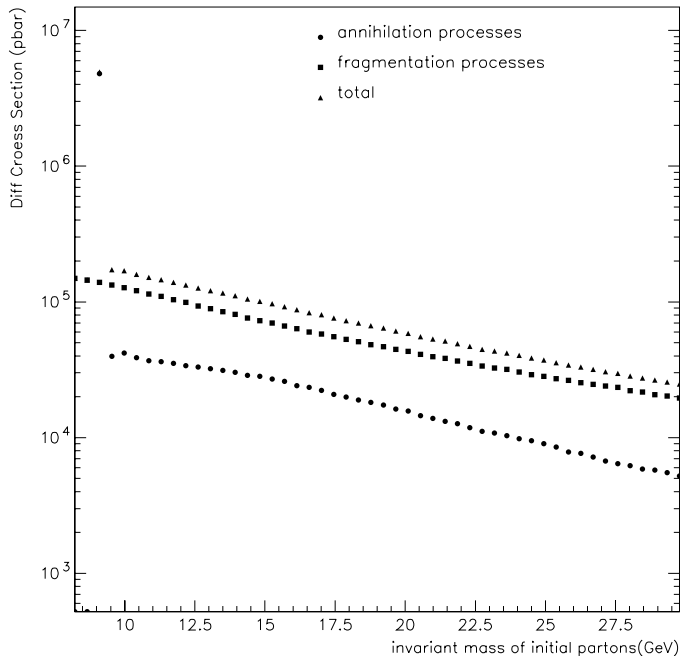

Fig. 1. Differential cross-section of η_b production vs c.m. energy of the 2 initial partons for the $2 \rightarrow 2$ tree-level processes

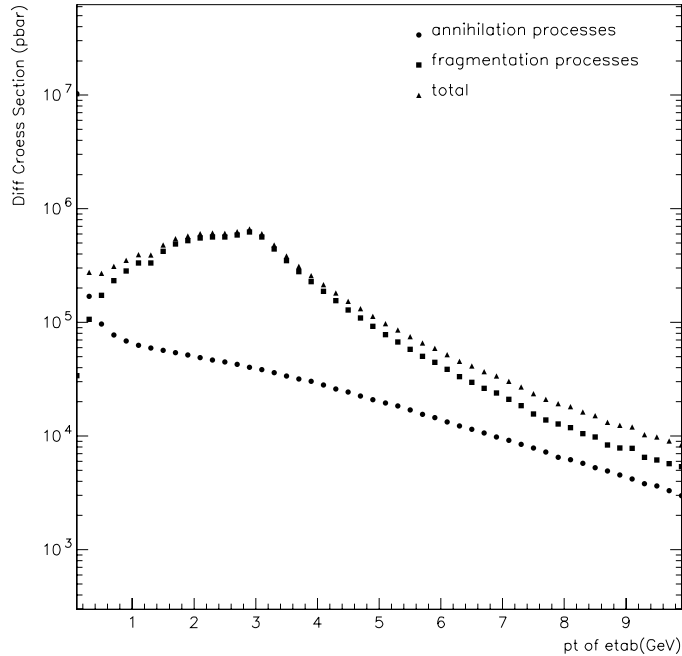

Fig. 2. η_b production cross-section vs transverse momentum p_t

This paper is organized as follows: The installation procedures and the directory structures are described in Section 2. In Section 3, we describe the details of the implementation of EtabFDC package. Section 4 presents the usage manual. Sections 5 describes the interface and format of the output files. The summary is presented in Section 6.

2 Installation and the directory structures

2.1 Installation

The EtabFDC runs under Linux system and GNU FORTRAN 77 compiler is required (other FORTRAN compilers are not tested). The necessary PYTHIA library files are included in the package for convenience. The CERN program Library 2001 or 2003 is also required, but not included with this package to avoid possible platform and compiler incompatibility. The package is distributed in a compressed file named `etabfdc.taz` and can be downloaded from FDC homepage:

http://www.ihep.ac.cn/lunwen/wjx/public_html/genpack/genpack.html

The installation steps are given below and for convenience we assume that ¹ :

1. the current user account is `user`;
2. the current directory is `/home/user`;
3. it is assumed that the user use "csh" ; if not , the user should execute "chsh useraccount" or "ypchsh useraccount" to change the shell class to cshell ;
4. CERN library should be CERN2001.

For the installation, user first need to decompress the downloaded gzip file by typing the following command.

```
"tar -xzvf etabfdc.taz"
```

then home directory "etabfdc" is generated. Secondly, get into it by "cd etabfdc" and set the correct path of CERN library in env.csh,then execute:

```
"source env.csh" and "installlib".
```

It will do the installation.

2.2 Directory structures

After the successful decompression and setting up the environment, user can find six sub-directories (see Fig. 3) in the installation directory. They are `basev5.1`, `etab-generator`, `f77`, `ggetab1`, `ggetab2` and `ggetab3`. The directory `basev5.1` stores BASES libraries used for Monte-Carlo calculation of the cross-section integral. The directory `f77` are the common-shared computational tools for η_b decay processes and the directory `etab-generator` contains the η_b production information.

`ggetab1`,`ggetab2` and `ggetab3` are three important directories that contain the parton-level annihilation and fragmentation channels, and correspond to three different η_b decay channels: $\eta_b \rightarrow J/\psi\gamma$, $\eta_b \rightarrow J/\psi J/\psi$ and $\eta_b \rightarrow J/\psi c\bar{c}$, respectively. All the compiled executable programs and the input files for each decay channel are stored here. Fully installed package substructure are shown in Fig. 3, based on which the EtabFDC package is constructed into three running levels.

Many generators (such as PYTHIA) are programmed in such a way that all implemented processes are packed into a single FORTRAN file and some variables are used to enable or disable these processes. Nevertheless, EtabFDC works in a different way. There are three running levels for generating $pp \rightarrow \eta_b X$ events. And each running level consists of a series of stand-alone executable programs and input-files which are stored in different sub-directories.

¹ Users can substitute the paths with their own working directory while installing the EtabFDC package.

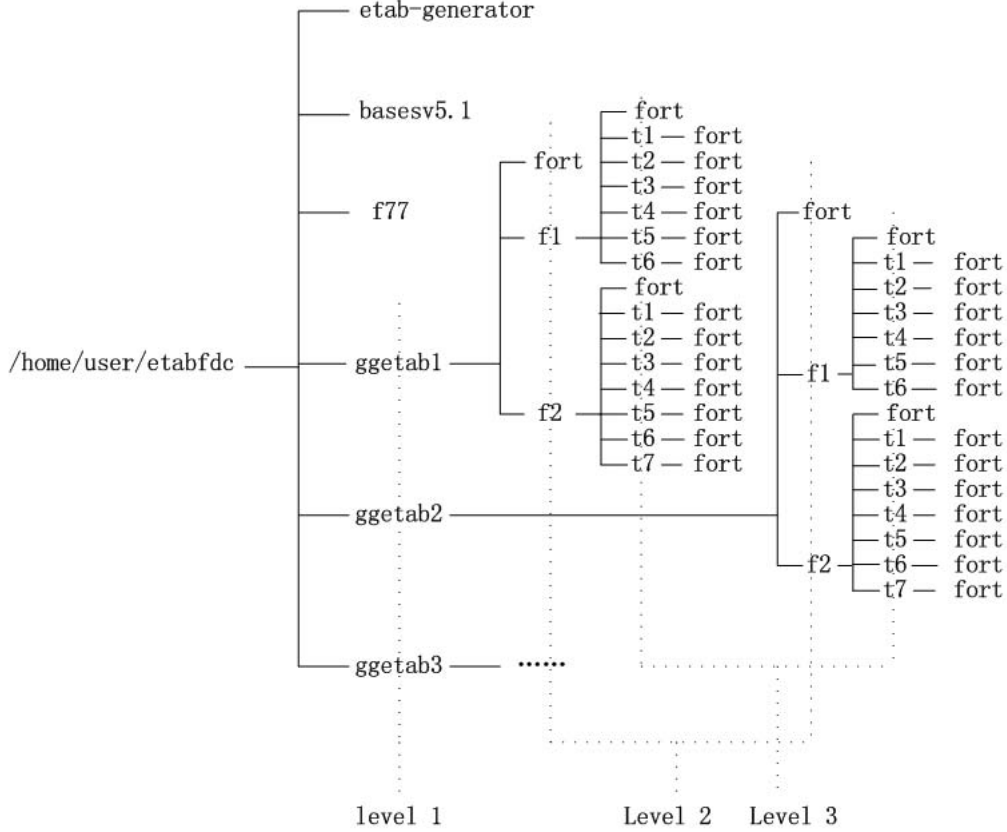

Fig. 3. Directory structure of EtabFDC

The introduction to the running levels and the details of substructure of the directories will be given in the following section.

3 Implementation

In EtabFDC, the cross section of each LO process is calculated by using BASES[15] package) at first and these cross sections are used as the weight for each processes. The spring in BASES is used to generate parton-level η_b events for each processes. and then the parton-level η_b events are passed to PYTHIA [17] by Les Houches Interface Standard[18] for partonic showering and hadronization. The interface with PYTHIA is shown in Fig. 6, and will be described in section 3.5.

We implement the EtabFDC in such a flexible way that users have options to select on generating events from three running levels.

3.1 Generality about running levels

As shown in Fig. 3, There is a set of stand-alone programs to generate events at each running level as, for all processes at running level 1, for a certain class, annihilation or fragmentation, of processes at running level 2, or for a specific process at running level 3.

For the three η_b decay channels, the programs for “level 1” are stored in `ggetab1/fort`, `ggetab2/fort` and `ggetab3/fort` respectively. The directories `f1` and `f2` under `ggetab1`(or `ggetab2,ggetab3`) are called **f-directories**, which contain the stand-alone programs for “level 2”. These programs are stored in `fn/fort`. `f1` or `f1` contains the annihilation or the fragmentation processes. The directories `t1`, `t2` and etc under f-directories are called **t-directories** for “level 3”. These programs are stored in `tn/fort` and can generate unweighted events for each specific process.

In the following, the symbol “ q ” is used to represent “ u, d, s ” quarks. The **t-directories** under `f1` for annihilation processes is :

$$t1 : q + \bar{q} \rightarrow \eta_b + \gamma$$

$$t2 : g + s \rightarrow \eta_b + s$$

$$t3 : g + d \rightarrow \eta_b + d$$

$$t4 : g + u \rightarrow \eta_b + u$$

$$t5 : g + g \rightarrow \eta_b + g$$

$$t6 : g + g \rightarrow \eta_b.$$

The Feynman diagrams are shown in Fig. 4 (u quark is used as example for q here).

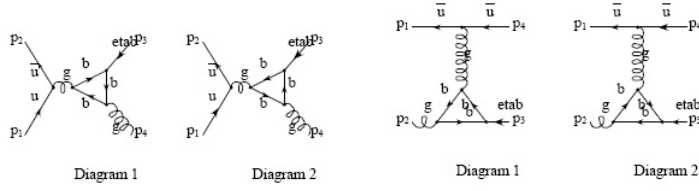

(a) $q + \bar{q} \rightarrow \eta_b + \gamma$ (b) $g + q \rightarrow \eta_b + q$

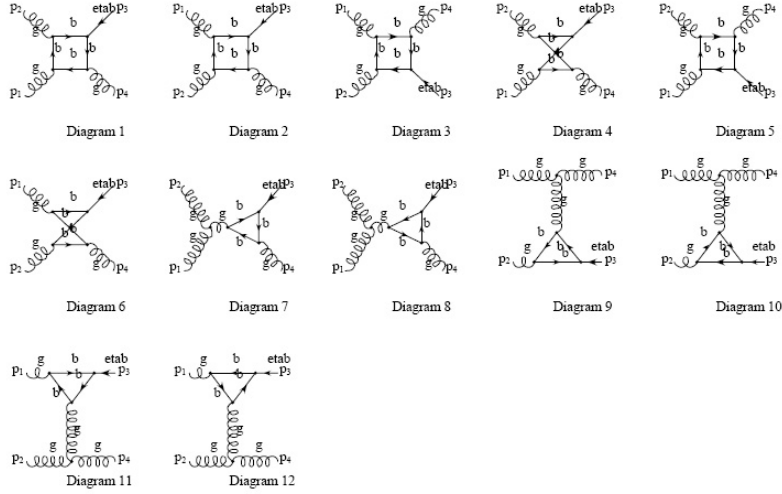

(c) $g + g \rightarrow \eta_b + g$

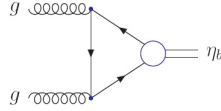

(d) $g + g \rightarrow \eta_b$

Fig. 4. Feynman diagrams for the leading-order annihilation processes in the η_b generation.

Similarly, the **t-directories** under **f2** for the fragmentation processes is:

- t1 : $q + \bar{q} \rightarrow g + g$
- t2 : $g + s \rightarrow g + s$
- t3 : $g + d \rightarrow g + d$
- t4 : $g + u \rightarrow g + u$
- t5 : $g + g \rightarrow g + g$
- t6 : $q + \bar{q} \rightarrow b + \bar{b}$
- t7 : $g + g \rightarrow b + \bar{b}$,

Where the gluon and b or \bar{b} can fragment into η_b . The Feynman diagrams are shown in Fig. 5 (u quark is used as example for q here).

For each process, the value of cross-section is saved in the file **fresult.dat** in **fort** directory under the directory of the process.

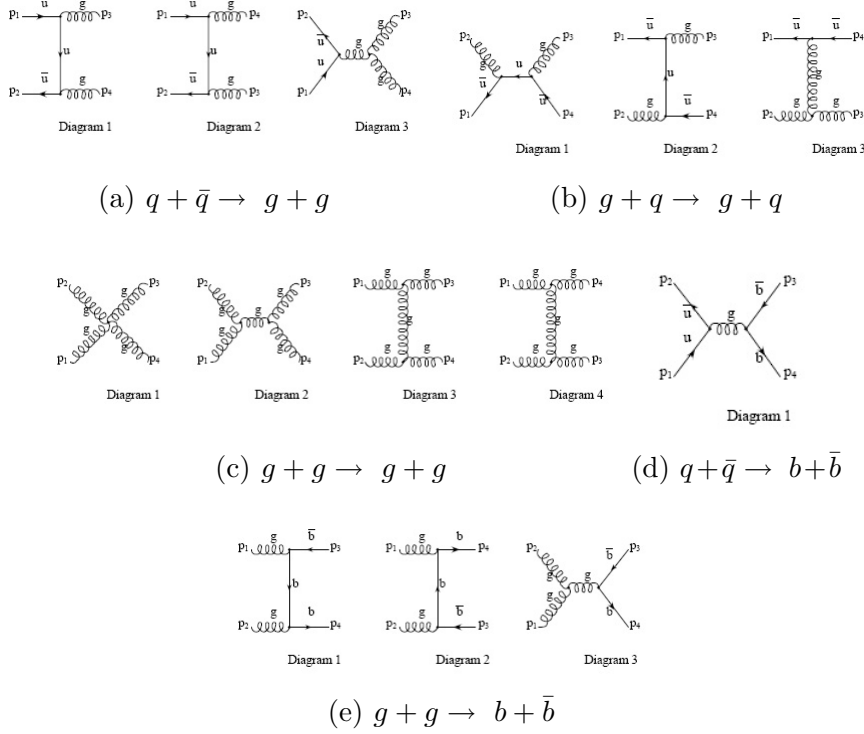

Fig. 5. Feynman diagrams for the leading-order fragmentation processes in the η_b generation.

Among the three running levels, only level 3 interfaces with PYTHIA directly, while level 1 and 2 interface with PYTHIA through level 3. Interfacing details will be described in section 3.5.

3.2 Running level 3

When EtabFDC runs at level 3, it first generates unweighted matrix-element events and then interfaces with PYTHIA for parton-showering and hadronization to obtain hadronic events. In this running level, each **t-directory** contains a specific parton-level process. There are three executable programs and one input-file stored in **ggetabn/tn/fort**. They are listed in table 1.

The programs **int** and **gevent** can be called by **fdcpythia** automatically. The program **fdcpythia** reads **parameter.input** for the initial parameters. The format of **parameter.input** is described as: each parameter occupies one line; in each line, the parameter name and value are separated by a equal sign (i.e. “=”) like:

Table 1
Executable programs in level 3

<code>int</code>	calculates and stores the cross-section in file <code>fort/fresult.dat</code>
<code>gevent</code>	generates and stores parton-level events with η_b being decayed in file <code>fort/pdata1.dat</code>
<code>fdcpythia</code>	interfaces with PYTHIA and stores the final hadronic events in file <code>fort/pyresult.dat</code>
<code>parameter.input</code>	input-file in which users can specify initial parameters such as running level and number of events

`parameter = value;`

the line which begins with a number sign (i.e. “#”) is recognized as the comment. All parameters used by EtabFDC in `parameter.input` of running level 3 are listed with brief explanation as:

`RUNNINGLEVEL(=1,2,3)` : To specify the running level. When EtabFDC runs at level 3, it should be set to 3 by users. Otherwise it will be set automatically.

`EVNTNUM` : To specify the number of the generated hadronic events.

`PARTONEVNTNUM` : The number of the generated parton-level events. Since PYTHIA can reject some parton-level events, we need to set this number greater than the final event number. Typically, it should be set at least 20 percent more than `EVNTNUM`.

`PRESENTEVNTNUM` : The number of generated hadronic events in the last run. It is set automatically and should not be modified by users.

`RESET` : To control the program `fdcpythia` to run in two different modes – **Re-generation** mode and **Appending** mode. In EtabFDC package, we only use the **Re-generation** mode (`=1`), since all the generated events are erased, and new parton-level events and hadronic events are generated.

3.3 Running level 2

When EtabFDC runs at level 2, it generates either annihilation or fragmentation class of parton-level events. For each class, the cross-section of each parton-level process are used as weight of the total generated number of events. In this level, each class of the processes corresponds to an f-directory. There are six programs for each class of processes which are stored in `ggetabn/fn/fort` and listed in table 2

Table 2
Executable programs for level 2

<code>int</code>	call <code>int</code> of every t-directory of the current class and stores the total cross-section in file <code>fort/fresult.dat</code>
<code>gevent</code>	generates and stores parton-level η_b events of current class in file <code>fort/pdata1.dat</code>
<code>fdcpythia</code>	generates hadronic events of the current class using cross-section of each process as weight and stores in file <code>fort/pyresult.dat</code>
<code>parameter.input</code>	input-file in which users can specify intimal parameters for the current run level
<code>pararefresh1</code>	pass parameter RESET in level 2 to level 3 and overwrite its value in level 3
<code>pararefresh2</code>	pass parameter RUNNINGLEVEL in level 2 to level 3 and overwrite its value in level 3
<code>pararefresh3</code>	pass parameter PARTONEVNTNUM in level 2 to level 3 and overwrite its value in level 3

The program `fdcpythia` uses cross-section as weight to determine the number of events for each process in the current class. And then each process calls its own `fdcpythia` for the event generation. After executed `fdcpythia`, user should go back to `ggetabn/fn` to execute `mmdir` to generate the hbook document for the annihilation or fragmentation process

The content of the configuration-file `parameter.input` is the same as the one at level 3 except the parameter `RUNNINGLEVEL` should be set to 2.

3.4 *Running level 1*

When EtabFDC runs at level 1, both annihilation and fragmentation processes are enabled in the event generation. There are six programs `int`, `gevent`, `fdcpythia`, `pararefresh1`, `pararefresh2` and `pararefresh3` stored in directory `ggetabn/fort` and function similarly as their counterparts at level 2. After executed `fdcpythia`, user should also go back to `ggetabn` to execute `mmdir` to generate the hbook document. The input-file `parameter.input` is also kept in `ggetabn/fort`, and its content is the same as the one at level 2 except that the parameter `RUNNINGLEVEL` should be set to 1.

3.5 Interface with PYTHIA

The EtabFDC generates parton-level events which consists of four-momenta and color flow information of all particles involved in a process. The event data are then stored in file `pdata1.dat` in corresponding directory `tn/fort` (see section 5 for the format of `pdata1.dat`). In turn, like many other matrix element generators such as AMEGIC++ [14] and AcerMC [16], EtabFDC interfaces with PYTHIA for parton showering and hadronization. This interface complies with PYTHIA standard and users can refer to PYTHIA manual[17]. Figure 6 shows the general procedures of the interface, and the source codes below is the event loop part in program `fdcpythia`

```
C... Event loop
      DO IEV=1,NEVNT
        CALL PYEVNT()
        CALL PYEDIT(1)
        IRECS=PYLIST_FDC(IFU2,IRECNO)
        IRECNO=IRECNO+IRECS
      ENDDO
```

A hadronic event is generated in a single run of the event loop. First, the PYTHIA subroutine `PYEVNT` calls another subroutine `UPEVNT` (which is provided by EtabFDC) to input a parton-level event. Then `PYEVNT` showers and hadronizes the parton-level event and stores the consequent hadronic event in common block `COMMON/PYJETS/`. Next, another PYTHIA subroutine `PYEDIT` is called to remove from the event record the jets or particles that have fragmented or decayed. Finally, a function `PYLIST_FDC`, which is a modified version of PYTHIA subroutine `PYLIST`, writes the `COMMON/PYJETS/` into file `pyresult.hbk` in `ntuple` mode.

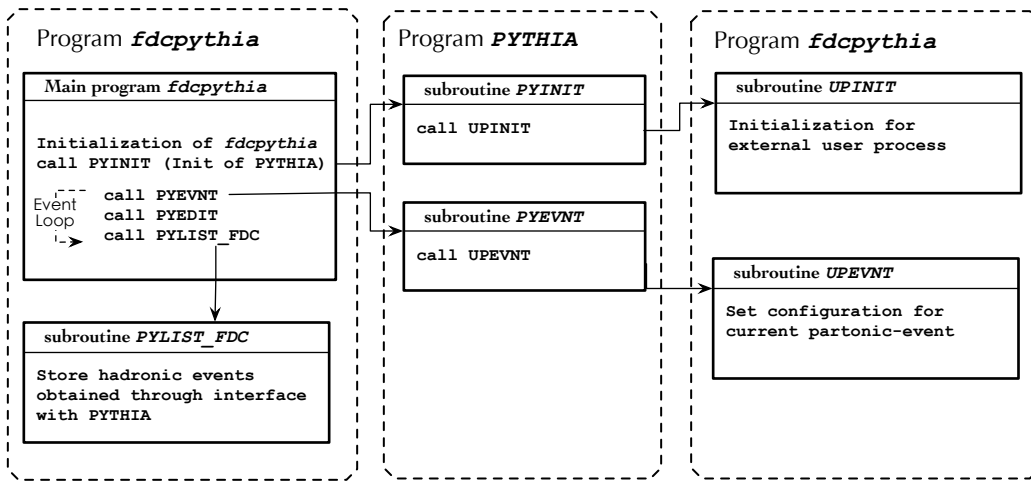

Fig. 6. Interface with PYTHIA

4 Usage

Users can choose the running level accordingly to their own needs. Instructions for running EtabFDC at the three running levels are given below.

4.1 For running level 3

It will be relatively convenient to add new physical processes in the future as well.

In this running level, EtabFDC can generate events for a specific process. To do this, follow the steps below:

- (1) Decide the physical process for which EtabFDC will generate events;
- (2) change current directory to the sub-directory `fort` under it (eg. `ggetab1/f2/t1/fort`);
- (3) Execute program `make clean` to remove old links;
- (4) Execute program `./make` to link and `./int` to calculate the cross-section;
- (5) Edit `parameter.input` and set parameters:
 - `RUNNINGLEVEL=3`;
 - `PARTONEVNTNUM` and `EVNTNUM` according to users' needs;
- (6) Execute program `./fdcpythia`.

With the steps above, `EVNTNUM` hadronic events are then stored in file `pyresult.hbk`.

4.2 For running level 2

In this running level, EtabFDC can generate events for either annihilation or fragmentation class of processes. To do this, follow the steps below:

- (1) Decide which class of process EtabFDC will generate events for and change current directory to the `f`-directory (eg. `ggetab2/f2`);
- (2) Execute program `./mkclean` to remove old links;
- (3) Execute program `./domake` to link and `./doint` to calculate the cross-section;
- (4) Change current directory to `ggetab2/f2/fort`
- (5) Edit `parameter.input` in current directory:
 - `RUNNINGLEVEL=2`;
 - `PARTONEVNTNUM` and `EVNTNUM` according to users' needs; and then execute `./pararefresh1`, `./pararefresh2` and `./pararefresh3` in directory `ggetab2/f2/fort`.
- (6) Execute `./fdcpythia` for hadronic events.

- (7) Go back to `ggetab2/f2` and execute `./mmdir` to get hbook document for the fragmentation processes.

With the above steps, the exact number of generated hadronic events in this run is given on screen and the data for these hadronic events are then stored in `f2.hbk` under `ggetab2/f2` directory.

4.3 For running level 1

In this running level, EtabFDC can generate events for all the implemented LO $2 \rightarrow 2$ processes for $pp \rightarrow \eta_b X$. To do this, follow the steps below:

- (1) Change the current directory to the sub-directory `fort` under it (eg. `ggetab2`);
- (2) Execute program `./mkclean` to cancel old links;
- (3) Execute program `./domake` to link and `./doimt` to calculate the cross-section;
- (4) Change current directory to `ggetab2/fort`
- (5) Edit `parameter.input` in current directory:
 - `RUNNINGLEVEL=1`;
 - `PARTONEVNTNUM` and `EVNTNUM` according to users' needs; and then execute `./pararefresh1`, `./pararefresh2` and `./pararefresh3` in directory `ggetab2/fort`.
- (6) Execute `./fdcpythia` for hadronic events.
- (7) Go back to `/ggetab2` and execute `./mmdir` to get hbook document for all LO $2 \rightarrow 2$ processes for $pp \rightarrow \eta_b + X$.

With steps above, the exact number of generated hadronic events in this run is given on screen and the data for these hadronic events are then stored in `ggetab2.hbk` under `ggetab2` directory.

5 Output files

As described above, the EtabFDC interfaces with PYTHIA directly at level 3. The partonic events information are kept in files named `pdata1.dat` of the corresponding directories `tn/fort` in ASCII format, and the hadronic events information are in file `pyresult.dat` in BINARY format in the same directory.

5.1 Format of *pdata1.dat*

File *pdata1.dat* is generated by program *gevent*. In this file, parton-level events are recorded in ASCII format sequentially. For a $2 \rightarrow n$ process, each partonic event in the file *pdata1.dat* occupies $2 + n$ lines (if not colored) or $2 + n + 1$ lines (if colored). The first $2 + n$ lines are four-momenta (\vec{p}, E) of initial and final particles. The $(2+n+1)$ th line is the coefficients of color bases, which are used as weight when there is a color-flow multiplicity. The color-flow assignment complies with the PYTHIA standard and users can refer to PYTHIA manual[17]. In this version of EtabFDC, no subroutines are provided for accessing to the parton-level events. The `FORMAT` statements which are used in *gevent* to output the four-momenta and the coefficients of color-flow bases is given below

```
FORMAT(2X,4(F14.8,1X))  
FORMAT(2X, $\mathcal{N}$ (F14.8,1X))
```

where \mathcal{N} is the number of color bases.

5.2 Format of *pyresult.hbk*

File *pyresult.hbk* is created by *fdcpythia*. As described in section 3.5, PYTHIA stores the hadronized events in a common block as below:

```
INTEGER N, NPAD, K  
DOUBLE PRECISION P, V  
COMMON/PYJETS/N, NPAD, K(4000,5), P(4000,5), V(4000,5)
```

Program *fdcpythia* then writes them into *pyresult.hbk* in ntuple format. If running level 1 or level 2, after executed `./fdcpythia`, the user should go back to `ggetabn` (for level 1) or `ggetabn/fn` (for level 2) and execute `./mvdirc` to get the hbook document for level 1 or level 2 separately. The hbook document could be read by *paw* directly.

6 Summary

We have presented a FORTRAN program package EtabFDC which is a matrix element event generator for simulating the production and the decays of η_b . It has implemented all possible leading-order $2 \rightarrow 2$ processes and can generate parton-level events through three running levels, and then interfaces with PYTHIA to obtain hadronic events, which are stored in the binary files and can be accessed by the provided FORTRAN subroutines. This package has been tested with setting the pp collisions energy at $\sqrt{s} = 14$ TeV and the mass of η_b to be 9.3 GeV. One of the attractive features of this package is that all its FORTRAN codes are generated by FDC with full automation. With this feature, the errors caused by carelessness can be systematically avoided.

Acknowledgments

This work was supported in part by NSFC under Grant No: 10491306,10521003,10775179, in part by the Scientific Research Fund of GUCAS with number 055101BM03 and 110200M202.

References

- [1] G.S. Bali, Phys. Rep. **343**, 1 (2001).
- [2] E.S. Ackleh, T. Barnes, Phys. Rev. D **45**, 232 (1992).
- [3] S. Godfrey, J.L. Rosner, Phys. Rev. D **64**, 074011 (2001).
- [4] L. Marcantonio et al., Nucl. Phys. (Proc. Suppl.) **94**, 363 (2001).
- [5] G.S. Bali, K. Schilling, A. Wachter, Phys. Rev. D **56**, 2566 (1997).
- [6] N. Brambilla, Y. Sumino, A. Vairo, Phys. Lett. B **513**, 381 (2001).
- [7] S. Narison, Phys. Lett. B **387**, 162 (1996).
- [8] E.J. Eichten, C. Quigg, Phys. Rev. D **49**, 5845 (1994).
- [9] D. Ebert, R.N. Faustov, V.O. Galkin, hep-ph/0006186.
- [10] J.X. Wang, Nucl. Instrum. Meth. A **534**, 241 (2004) [arXiv:hep-ph/0407058].
- [11] J. X. Wang, Prepared for 6th Accelerator and Particle Physics Institute (APPI 2001), Morioka, Japan, 20-23 Feb 2001. Published in Appi 2001, "Accelerator and particle physics," 108-121

- [12] Gang Hao, Yu Jia, Cong-Feng Qiao, Peng Sun, JHEP **0702** 057(2007).
- [13] Gang Hao, Cong-Feng Qiao, Peng Sun, Phys. Rev. D **76**, 125013 (2007).
- [14] F. Krauss, R. Kuhn and G. Soff, JHEP **0202**, 044 (2002) [arXiv:hep-ph/0109036].
- [15] S. Kawabata, Computer Phys. Commun. **88**, 309 (1995).
- [16] B. P. Kersevan and E. Richter-Was, arXiv:hep-ph/0405247.
- [17] T. Sjöstrand, *et al.*, Computer Physics Commun. **135** (2001) 238.
- [18] E. Boos, *et al.*, “Generic User Process Interface for Event Generators”, arXiv:hep-ph/0109068.

Appendix : Usage Illustrations

Users can choose the running level for their own purposes.

Following examples will be used to explain the usage of EtabFDC for 3 running levels.

.1 Level 3

In this level, user can generate events for a specific process.

It is supposed to generate 1,000 hadronic events for process $q+\bar{q} \rightarrow g+\eta_b(q = uds)$, $\eta_b \rightarrow J/\psi J/\psi$.

For this purpose, following steps are needed.

- 1) This process corresponds to directory `ggetab2/f1/t1`.
- 2) Change current directory to `ggetab2/f1/t1/fort`.
- 3) Edit `parameter.input` and set
 `EVNTNUM = 1000,`
 `RUNNINGLEVEL = 3,`
 `RESET = 1.`
- 4) Execute `./int` for cross-section. (optional)
- 5) Execute `./fdcpythia` for hadronic events.

Remarks:

- 1) The step 4 is optional since the events are generated unweighted in level 3. Therefore, if users do not want to know the cross-section, they can omit this step.
- 2) When `./int` runs successfully, it will give no message on screen. However, if the mass of final-particles are greater than that of initial particles, which means the process is prohibited by current energy configuration, `./int` prints a message, “The center mass energy < the sum of all final mass”. When this message appears, users should not execute `./fdcpythia` or `./gevent`.
- 3) As mentioned in section 3, the parton-level events are generated by `./gevent`. However, as shown in steps above, `./gevent` is not used explicitly. That is because `./fdcpythia` can execute `./gevent` automatically according to parameters set in `parameter.input`. Of course, if users are only interested in the parton-level events, they can execute `./gevent` manually instead of `./fdcpythia`.
- 4) Parton-level and hadronic events are stored in `pdata1.dat` and `pyresult.hbk`

respectively in the directory `ggetabn/f1/t1/fort`. The access to them is formulated in section 5.

.2 Level 2

In this level, users can generate events for the annihilation or fragmentation processes followed by which η_b decays in certain channel.

As an example, we take annihilation-`etab`-generating processes decay as $\eta_b \rightarrow J/\psi + J/\psi$. It is assumed to generate 5,000 hadronic events. For this purpose, users need to go through steps below.

- 1) The annihilation-`etab`-generating processes correspond to `ggetab2/f1`, then go into this directory.
- 2) Execute shell script `./doint`.
- 3) Change current directory to `ggetab2/f1/fort`
- 4) Edit `parameter.input` in current directory and set
 `EVNTNUM = 5000,`
 `RUNNINGLEVEL = 2,`
 `RESET = 1.`
and then execute `./pararefresh1`, `./pararefresh2` and `./pararefresh3` in directory `ggetab2/f1/fort`.
- 5) Execute `./fdcpythia` for hadronic events.
- 6) Go back to `ggetab2/f1` and execute `./mmdir` to get the `hbook` document

Remarks:

- 1) Users should notice that in level 2 (also in level 1), shell scripts should be used instead of executable programs `./int`.
- 2) In level 2 (also in level 1), the execution of `./doint` is a necessary step since the generator needs the cross-section as weight to determine the number of events for each specific process.
- 3) As in level 3, parton-level events are stored in sub-directory `fort` of corresponding `t`-directories under `ggetab2/f1`. The access to them has been described in section 5.

.3 Level 1

In this level, users can generate events for all processes. We take the $\eta_b \rightarrow J/\psi\gamma$ decay channel as an example. It is assumed that 10,000 hadronic events are generated. For this purpose, following steps are necessary.

- 1) Change current directory to `ggetab1`.
- 2) Execute shell script `./doimt`.
- 3) Change current directory to `ggetab1/fort`
- 4) Edit `parameter.input` in current directory. Set
 `EVNTNUM = 10000,`
 `RUNNINGLEVEL = 1,`
 `RESET = 1.`
and then execute `./pararefresh1`, `./pararefresh2` and `./pararefresh3`
in directory `ggetab1/fort`.
- 5) Execute `./fdcpythia` for hadronic events.
- 6) Go back to `ggetab1` and execute `./mmdir` to get the hbook document.

Remark:

Except the directory, everything is the same as in level 2. The parton-level event files are also kept in `fort` of corresponding t-directories.