

Quantum fields with classical perturbations

Jan Dereziński
Dept. of Math. Methods in Phys.,
Faculty of Physics, University of Warsaw
Hoza 74, 00-682 Warszawa, Poland
email Jan.Derezinski@fuw.edu.pl

September 13, 2018

Abstract

The main purpose of these notes is a review of various models of Quantum Field Theory involving quadratic Lagrangians. We discuss scalar and vector bosons, spin $\frac{1}{2}$ fermions, both neutral and charged. Beside free theories, we study their interactions with classical perturbations, called, depending on the context, an external linear source, mass-like term, current or electromagnetic potential. The notes may serve as a first introduction to QFT.

Contents

0	Introduction	7
1	Basic concepts	11
1.1	Minkowski space	11
1.1.1	Coordinates in Minkowski space	11
1.1.2	Causal structure	12
1.1.3	Fourier transform	12
1.1.4	Lorentz and Poincaré groups	13
1.1.5	Double coverings of Lorentz and Poincaré groups	13
1.1.6	Complex Lorentz groups	15
1.2	General concepts of quantum field theory	16
1.2.1	Quantum mechanics	16
1.2.2	Time reversal	16
1.2.3	Relativistic quantum mechanics	18
1.2.4	Haag-Kastler axioms for observable algebras	19
1.2.5	Haag-Kastler axioms for field algebras	20
1.2.6	Global symmetries	21

1.2.7	Neutral quantum fields	21
1.2.8	Wightman axioms for neutral fields	22
1.2.9	Relationship between Haag-Kastler and Wightman axioms	23
1.2.10	Global symmetries in the Wightman formalism	23
1.2.11	Charged fields	24
1.2.12	Wightman axioms for neutral and charged fields	25
1.2.13	$U(1)$ symmetry	26
1.2.14	Charge conjugation	26
1.2.15	Parity invariance	27
1.2.16	Time reversal invariance	27
1.2.17	The CPT Theorem	28
1.2.18	The CPT Theorem in a P and T -invariant theory	28
1.2.19	N -point Wightman and Green's functions	29
1.3	General scattering theory	30
1.3.1	Time ordered exponential	30
1.3.2	Heisenberg picture	31
1.3.3	Time-dependent perturbations	32
1.3.4	Time ordered Green's functions	33
1.3.5	Adiabatic switching and the energy shift	34
1.3.6	Adiabatic switching and Green's functions	37
1.3.7	Adiabatic scattering theory	38
2	Neutral scalar bosons	39
2.1	Free neutral scalar bosons	40
2.1.1	Special solutions and Green's functions	40
2.1.2	Space of solutions	42
2.1.3	Classical fields	44
2.1.4	Poisson brackets	45
2.1.5	Smeared fields	45
2.1.6	Lagrangian formalism	46
2.1.7	Stress-energy tensor	47
2.1.8	Diagonalization of the equations of motion	48
2.1.9	Plane waves	49
2.1.10	Positive frequency space	50
2.1.11	Quantization	51
2.1.12	Quantization in terms of smeared fields	53
2.1.13	Quantization in terms of C^* -algebras	54
2.1.14	Two-point functions	54
2.2	Neutral scalar bosons with a linear source	55
2.2.1	Classical fields	55
2.2.2	Lagrangian and Hamiltonian formalism	56
2.2.3	Quantization	57
2.2.4	Operator valued source	58
2.2.5	Scattering operator	59
2.2.6	Green's functions	60
2.2.7	Path integral formulation	61

2.2.8	Feynman rules	62
2.2.9	Vacuum energy	63
2.2.10	Problems with the scattering operator	63
2.2.11	Energy shift and scattering theory for a stationary source	64
2.2.12	Travelling source	65
2.2.13	Scattering cross-sections	68
2.2.14	Inclusive cross-section	68
2.3	Neutral scalar bosons with a mass-like perturbation	70
2.3.1	Classical fields	70
2.3.2	Lagrangian and Hamiltonian formalism	71
2.3.3	Dynamics in the interaction picture	71
2.3.4	Quantization	72
2.3.5	Quantum Hamiltonian	73
2.3.6	Path integral formulation	74
2.3.7	Feynman rules	74
2.3.8	Vacuum energy	76
2.3.9	Pauli-Villars renormalization	77
2.3.10	Renormalization of the vacuum energy	78
2.3.11	Method of dispersion relations	79
2.3.12	Wick rotation	80
2.3.13	Dimensional renormalization	81
2.3.14	Energy shift	82
3	Massive photons	83
3.1	Free massive photons	84
3.1.1	Space of solutions	84
3.1.2	Classical 4-potentials	84
3.1.3	Poisson brackets	85
3.1.4	Smeared 4-potentials	86
3.1.5	Lagrangian formalism and stress-energy tensor	86
3.1.6	Diagonalization of the equations of motion	88
3.1.7	Plane waves	91
3.1.8	Positive frequency space	91
3.1.9	Spin averaging	92
3.1.10	Quantization	92
3.2	Massive photons with an external 4-current	94
3.2.1	Classical 4-potentials	94
3.2.2	Lagrangian and Hamiltonian formalism	95
3.2.3	Quantization	96
3.2.4	Causal propagators	98
3.2.5	Feynman rules	99
3.2.6	Path integral formulation	99
3.2.7	Energy shift	101
3.3	Alternative approaches	102
3.3.1	Classical 4-potentials without the Lorentz condition	102
3.3.2	The Lorentz condition	103

3.3.3	Diagonalization of the equations of motion	104
3.3.4	Positive frequency space	106
3.3.5	“First quantize, then reduce”	107
3.3.6	Quantization without reduction on a positive definite Hilbert space	107
3.3.7	The Gupta-Bleuler approach	108
4	Massless photons	109
4.1	Free massless photons	110
4.1.1	Space of solutions and the gauge invariance	110
4.1.2	Classical 4-potentials	112
4.1.3	Smeared 4-potentials	113
4.1.4	Lagrangian formalism and the stress-energy tensor	113
4.1.5	Diagonalization of the equations of motion	114
4.1.6	Positive frequency space	115
4.1.7	Spin averaging	116
4.1.8	Quantization	116
4.1.9	Quantization in terms of C^* -algebras	118
4.2	Massless photons with an external 4-current	118
4.2.1	Classical fields	118
4.2.2	Lagrangian and Hamiltonian formalism	120
4.2.3	Quantization	121
4.2.4	Causal propagators	122
4.2.5	Path integral formulation	122
4.2.6	The $m \rightarrow 0$ limit	123
4.2.7	Current produced by a travelling particle	124
4.2.8	Energy shift	125
4.3	Alternative approaches	125
4.3.1	Manifestly Lorentz covariant formalism	125
4.3.2	The Lorentz condition	126
4.3.3	Positive frequency space	127
4.3.4	“First quantize, then reduce”	128
4.3.5	Quantization with a subsidiary condition	128
4.3.6	The Gupta-Bleuler approach	129
5	Charged scalar bosons	129
5.1	Free charged scalar bosons	130
5.1.1	Classical fields	130
5.1.2	Smeared fields	131
5.1.3	Lagrangian formalism	132
5.1.4	Classical 4-current	133
5.1.5	Stress-energy tensor	134
5.1.6	Diagonalization of the equations of motion	134
5.1.7	Plane waves	136
5.1.8	Positive and negative frequency subspace	137
5.1.9	Quantization	138

5.1.10	Quantum 4-current	140
5.1.11	Quantization in terms of smeared fields	142
5.2	Charged scalar bosons in an external 4-potential	143
5.2.1	Classical fields	143
5.2.2	Lagrangian and Hamiltonian formalism	144
5.2.3	Classical discrete symmetries	145
5.2.4	Quantization	146
5.2.5	Quantum Hamiltonian	147
5.2.6	Quantized discrete symmetries	147
5.2.7	$2N$ -point Green's functions	149
5.2.8	Path integral formulation	150
5.2.9	Feynman rules	150
5.2.10	Vacuum energy	152
5.2.11	Pauli-Villars renormalization	153
5.2.12	Renormalization of the vacuum energy	156
5.2.13	Method of dispersion relations	157
5.2.14	Dimensional renormalization	157
5.2.15	Abstract gauge covariance	158
5.2.16	Ward identities	159
5.2.17	Energy shift	161
6	Dirac fermions	161
6.1	Free Dirac fermions	162
6.1.1	Dirac spinors	162
6.1.2	Special solutions and Green's functions	163
6.1.3	Space of solutions	164
6.1.4	Classical fields	166
6.1.5	Smeared fields	166
6.1.6	Diagonalization of the equations of motion	166
6.1.7	Plane wave functionals	168
6.1.8	Positive and negative frequency subspaces	168
6.1.9	Spin averaging	169
6.1.10	Quantization	170
6.1.11	Quantization in terms of smeared fields	171
6.1.12	Dirac sea quantization	172
6.1.13	Fermionic Hamiltonian formalism	173
6.1.14	Fermionic Lagrangian formalism	174
6.1.15	Classical 4-current	175
6.1.16	Quantum 4-current	176
6.2	Dirac fermions in an external 4-potential	178
6.2.1	Dirac equation in an external 4-potential	178
6.2.2	Lagrangian and Hamiltonian formalism	179
6.2.3	Classical discrete symmetries	179
6.2.4	Quantization	181
6.2.5	Quantum Hamiltonian	181
6.2.6	Quantized discrete symmetries	182

6.2.7	2N-point Green's functions	183
6.2.8	Path integral formulation	184
6.2.9	Feynman rules	184
6.2.10	Vacuum energy	185
6.2.11	Pauli-Villars renormalization	186
6.2.12	Method of dispersion relations	187
6.2.13	Dimensional renormalization	188
6.2.14	Energy shift	189
7	Majorana fermions	190
7.1	Free Majorana fermions	190
7.1.1	Charge conjugation	190
7.1.2	Space of solutions	190
7.1.3	Smearred fields	191
7.1.4	Plane waves	191
7.1.5	Quantization	192
7.1.6	Quantization in terms of smeared fields	193
7.2	Majorana fermions with a mass-like perturbation	193
7.2.1	Classical fields	193
7.2.2	Lagrangian and Hamiltonian formalism	194
7.2.3	Quantum fields	194
7.2.4	Path integral formulation	195
7.2.5	Vacuum energy	195
7.2.6	Renormalization of the vacuum energy	195
7.2.7	Pauli-Villars renormalization of the 2nd order term	196
A	Appendix	197
A.1	Second quantization	197
A.1.1	Fock spaces	197
A.1.2	Creation/annihilation operators	198
A.1.3	Weyl/antisymmetric and Wick quantization	199
A.1.4	Second quantization of operators	201
A.1.5	Implementability of Bogoliubov translations	201
A.1.6	Implementability of Bogoliubov rotations	202
A.1.7	Infimum of a van Hove Hamiltonian	202
A.1.8	Infimum of a Bogoliubov Hamiltonian	203
A.2	Miscellanea	204
A.2.1	Identities for Feynman integrals	204
A.2.2	Identities for the dimensional regularization	205
A.2.3	Operator identities	206
A.2.4	Coulomb and Yukawa potential	206
A.2.5	Vector fields	206
A.2.6	Dispersion relations	207

0 Introduction

In these notes we discuss various models of Quantum Field Theory in 1+3 dimensions involving quadratic Lagrangians or, equivalently, quadratic Hamiltonians.

First of all, we describe basic types of *free fields*:

- (1) *neutral scalar bosons*,
- (2) *neutral massive vector bosons* (“*massive photons*”),
- (3) *neutral massless vector bosons* (“*massless photons*”),
- (4) *charged scalar bosons*,
- (5) (charged) *Dirac fermions*,
- (6) (neutral) *Majorana fermions*.

We also consider free fields perturbed by a linear or quadratic perturbation involving a classical (*c*-number) function.

- (1) neutral scalar bosons interacting with a *linear source*,
- (2) neutral scalar bosons interacting with a *mass-like perturbation*,
- (3) massive photons interacting with a *classical 4-current*,
- (4) massless photons interacting with a *classical 4-current*,
- (5) charged scalar bosons interacting with an *electromagnetic 4-potential*,
- (6) Dirac fermions interacting with an *electromagnetic 4-potential*,
- (7) Majorana fermions interacting with a *mass-like perturbation*.

All the above models are (or at least can be) well understood in the non-perturbative sense. Perturbation theory is not necessary to compute their *scattering operators* and *Green's functions*, which is not the case (at least so far) of truly interacting models.

Quantum fields interacting with classical perturbations is a topic with many important applications to realistic physical systems. Therefore, the formalism developed in our text is well motivated physically.

Clearly, many important issues of quantum field theory are outside of the scope of free fields interacting with classical perturbations. However, surprisingly many difficult topics can be discussed already on this level. Therefore, we believe that our text has pedagogical value, as a kind of an introduction to full quantum field theory.

In our text we stress the deductive character of quantum field theory. Models that we discuss are quite rigid and built according to strict principles. Among these principles let us mention the *Poincaré covariance*, the *Einstein causality* and the *boundedness of the Hamiltonian from below*. Some of these principles are encoded in the *Haag-Kastler* and *Wightman axioms*. Even if these axioms are often too restrictive, they provide useful guidelines.

The only known models for Haag-Kastler or Wightman axioms in 1+3 dimensions are free theories. Their scattering theory is trivial. To obtain interesting

physical information one needs *interacting theories*. Unfortunately, interacting theories are known only perturbatively.

Free theories are the quantizations of covariant 2nd order linear hyperbolic equations on the Minkowski space. These equations can be perturbed by 0th or 1st order terms involving an arbitrary space-time functions called, depending on the context, a classical (=external) linear source, mass-like term, 4-current or electromagnetic 4-potential. We can consider the quantization of the perturbed equation. Such a theory is still essentially exactly solvable, since the Hamiltonian is quadratic. It has no Poincaré covariance. However, it still gives rise to a net of observable algebras satisfying the Einstein causality.

In our discussion we always start from the study of a *classical theory*, which we discuss from the Hamiltonian and Lagrangian point of view. Then we discuss its quantization. Even though in all the cases we consider the Hamiltonian is quadratic, its quantization often has various subtle points. In some cases, especially for vector fields, there are several natural approaches to quantization, which in the end lead to the same physical results. We try to discuss various possible approaches. In our opinion, the existence of seemingly different formalisms for the same physical system constitutes one of the most confusing aspects of quantum field theory.

Classical perturbations that we consider are usually described by smooth space-time functions that decay fast both in space and time. In particular, their dynamics is typically described by *time-dependent Hamiltonians*. This is a certain minor difficulty, which is often ignored in the literature. We discuss how to modify the usual formalism in order to deal with this problem.

The models that we discuss illustrate many problems of interacting theories, such as the *ultraviolet problem*, the *infrared problem* and the *gauge invariance*.

The ultraviolet problem means that when we try to define a theory in a naive way some integrals are divergent for large momenta. In the context of our paper this is never due to classical perturbations, which we always assume to be smooth – the source of ultraviolet divergences is the behavior of propagators.

The ultraviolet problem is already visible when we consider neutral fields with a masslike perturbation or charged fields with a classical electromagnetic 4-potential. In these systems classical dynamics exists under rather weak assumptions. However there are problems with the quantum dynamics.

In some cases the quantum dynamics cannot be implemented on a Hilbert space. This is the case of charged particles (bosons or fermions) in the presence of variable spatial components of the 4-potential. On the other hand, the scattering operator exists under rather weak assumptions for 4-potential going to zero in the past and future.

Even if we are able to implement the classical dynamics or the classical scattering operator, we encounter another unpleasant surprise. The only quantity that is not fixed by the classical considerations is the phase factor of the scattering operator, written as $e^{-i\mathcal{E}/\hbar}$, where \mathcal{E} is usually called the *vacuum energy*. Computed naively, it often turns out to be divergent. In order to make this phase factor finite it is necessary to renormalize the naive expression. This divergence appears in low order vacuum energy diagrams. It was first successfully

studied by Heisenberg and Euler in the 30's. A quantity closely related to this phase factor is the *effective action*, which for a constant field was computed exactly by Schwinger.

The infrared problem means that in the naive theory some integrals are divergent for small momenta. This problem appears already in non-relativistic quantum mechanics – in scattering theory with *Coulomb forces*. These forces are *long-range*, which makes the usual definition of the scattering operator impossible [14]. Its another manifestation is the appearance of *inequivalent representations of canonical commutation relations*, when we consider scattering of photons against a classical 4-current that has a different direction in the past and in the future [13, 15]. Thus, even in these toy non-relativistic situations the usual scattering operator is ill-defined. Therefore, it is not surprising that (much bigger) problems are present eg. in the full QED. One can cope with the infrared problem by approximating massless photons with massive ones and restricting computations only to *inclusive cross-sections* justified by an *imperfect resolution* of the measuring device [58, 27, 56].

The expression *gauge invariance* has in the context of quantum field theory several meanings.

- (1) The most common meaning, discussed already in the context of classical electrodynamics, is the fact that if a *total derivative* is added to a 4-potential solving the Maxwell equation, then it still solves the Maxwell equations. Of course, this no longer holds for the *Proca equations* – the massive generalization of the Maxwell equations. Therefore, it is often stressed that gauge invariance implies that the photons are massless.
- (2) There exists another meaning of gauge invariance: we can multiply *charged fields* by a *space-time dependent phase factor* and compensate it by changing the external potentials.
 1. and 2. go together in the full QED, which is invariant with respect to these two gauge transformations applied simultaneously.
- (3) One often uses the term “gauge invariance” in yet another meaning: To compute the scattering operator we can use various (*free*) *photon propagators*. Equivalently, we have the freedom of choosing a Lagrangian in the path integral formalism. This meaning applies both to massive and massless photons. Some of these propagators are distinguished, such as the *propagator in the Feynman or the Coulomb gauge*. (Note, however, that time-ordered N -point Green's functions depend on the choice of the propagator).

All these three meanings of gauge invariance can be illustrated with models that we consider.

The paper is most of the time rigorous mathematically. In the places where it is not, we believe that many readers can quite easily make it rigorous. We try to make the presentation of various models parallel by applying, if possible, coherent notation and formalism. This makes our text sometimes repetitious – we believe that this helps the reader to understand small but often confusing

differences between distinct models.

Mathematical language that we use is most of the time elementary. Sometimes we use some mathematical concepts and facts that are, perhaps, less commonly known, such as C^* -algebras, von Neumann algebras, the Schwartz Kernel Theorem. The readers unfamiliar with them should not be discouraged – their role in the article is minor.

Most of the material of this work has been considered in one way or another in the literature. Let us give a brief and incomplete review of references.

On the formal level examples of quantum fields with classical perturbations are discussed in most textbooks on quantum field theory, see eg. [26, 27, 47, 51, 56, 55, 5].

Linear hyperbolic equations is a well established domain of partial differential equations, see eg [3].

Axioms of quantum field theory are discussed in [53, 23, 22].

A necessary and sufficient condition for the implementability of Bogoliubov transformation was given by Shale for bosons [49] and by Shale and Stinespring for fermions [50], see also [15]

Problems with implementability of the dynamics of charged particles in external potentials was apparently first noticed on a heuristic level in [46]. It was studied rigorously by various authors. In particular, charged bosons were studied in [48, 36, 37, 38, 25, 1] and charged fermions in [41, 30, 29, 44, 12]. Rigorous discussion of the smeared out local charge for charged fermions is contained in [33].

The renormalization of the vacuum energy goes back to pioneering work of [24]. In the mathematically rigorous literature it leads to the concept of a causal phase discussed in the fermionic case in [45, 21].

The infrared problem goes back to [7, 28], see also [13].

The Gupta-Bleuler method of quantization of photon fields goes back to [19, 6]. The C^* -algebraic formulation of the subsidiary condition method is discussed in [54].

Rigorous study of vacuum energy for Dirac fermions in a stationary potential is given in [18].

A topic that not included in these notes are *anomalies* in QFT, which to a large extent can be treated in the context of external classical perturbations [20, 32, 10]

The notes also treat only dimension 1+3. Note, however, that related problems can be considered in other dimensions. Of particular importance is the case of 1+1 dimension with a large literature, eg. [11, 34]

Acknowledgements The origins of these notes go back to a lecture course on QED at LMU, Munich, which I prepared at the request of H.Siedentop. The course, with some modifications, was then repeated at IHP, Paris, at the request of M.Lewin, at the Copenhagen University at the request of J.P.Solovej, at Warsaw University, and at CRM, Montreal, at the request of V.Jaksic and R.Seiringer. I am grateful to the colleagues who invited me to give these courses for their support and advice. Remarks of participants of my courses, among

them of P.Majewski, E.Stockmeier, P.Pickl, D.-A.Deckert, P.Duch and M.Duch are also appreciated. I profited also from the criticism of E.Langmann and anonymous referees.

I am grateful to the experts in quantum field theory, K.Pachucki, I.B.Białynicki-Birula, K.Meissner, V.Shabaev and P.Chankowski, who answered my various questions.

Last but not least, I profited greatly from my long time collaboration with C.G erard.

My research was supported in part by the National Science Center (NCN) grant No. 2011/01/B/ST1/04929.

1 Basic concepts

1.1 Minkowski space

1.1.1 Coordinates in Minkowski space

The coordinates of the *Minkowski space* $\mathbb{R}^{1,3}$ will be typically denoted by x^μ , $\mu = 0, 1, 2, 3$. By definition, the Minkowski space is the vector space \mathbb{R}^4 equipped with the canonical pseudo-Euclidean form of signature $(-+++)$

$$g_{\mu\nu}x^\mu x^\nu = -(x^0)^2 + \sum_{i=1}^3 (x^i)^2.$$

(Throughout these notes the velocity of light has the value 1 and we use the *Einstein summation convention*). We use metric tensor $[g_{\mu\nu}]$ to lower indices and its inverse $[g^{\mu\nu}]$ to raise indices:

$$x_\mu = g_{\mu\nu}x^\nu, \quad x^\mu = g^{\mu\nu}x_\nu.$$

For a function $\mathbb{R}^{1,3} \ni x \mapsto f(x)$, we will sometimes use various kind of notation for partial derivatives:

$$\frac{\partial f(x)}{\partial x^\mu} = \partial_{x^\mu} f(x) = \partial_\mu f(x) = f_{,\mu}(x).$$

Writing \mathbb{R}^3 we will typically denote the *spatial part* of the Minkowski space obtained by setting $x^0 = 0$. If $x \in \mathbb{R}^{1,3}$, then \vec{x} will denote the projection of x onto \mathbb{R}^3 . Latin letters i, j, k will sometimes denote the spatial indices of a vector. Note that $x_i = x^i$.

ϵ^{ijk} denotes the 3-dimensional Levi-Civita tensor (the fully antisymmetric tensor satisfying $\epsilon^{123} = 1$).

For a vector field $\mathbb{R}^3 \ni \vec{x} \mapsto \vec{A}(\vec{x})$ we define its *divergence* and *rotation* in the standard way:

$$\operatorname{div} \vec{A} = \partial_i A^i, \quad (\operatorname{rot} \vec{A})^i = \epsilon^{ijk} \partial_j A_k.$$

We write $\vec{\partial A}$ as the shorthand for the tensor $\partial_i A_j$, moreover,

$$(\vec{\partial A})^2 := \sum_{ij} (\partial_i A_j)^2.$$

On $\mathbb{R}^{1,3}$ we have the standard Lebesgue measure denoted dx . The notation $d\vec{x}$ will be used for the Lebesgue measure on $\mathbb{R}^3 \subset \mathbb{R}^{1,3}$.

We will often write t for $x^0 = -x_0$. The time derivative will be often denoted by a dot:

$$\dot{f}(t) = \frac{\partial f(t)}{\partial t} = \partial_t f(t) = \frac{\partial f(x^0)}{\partial x^0} = \partial_0 f(x^0) = f_{,0}(x^0).$$

$\theta(t)$ will denote the Heaviside function. We set $|t|_+ := \theta(t)|t|$.

1.1.2 Causal structure

A nonzero vector $x \in \mathbb{R}^{1,3}$ is called

$$\begin{aligned} \textit{timelike} & \text{ if } x_\mu x^\mu < 0, \\ \textit{causal} & \text{ if } x_\mu x^\mu \leq 0, \\ \textit{lightlike} & \text{ if } x_\mu x^\mu = 0, \\ \textit{spacelike} & \text{ if } x_\mu x^\mu > 0. \end{aligned}$$

A causal vector x is called

$$\begin{aligned} \textit{future oriented} & \text{ if } x^0 > 0, \\ \textit{past oriented} & \text{ if } x^0 < 0. \end{aligned}$$

The set of future/past oriented causal vectors is called the *future/past light cone* and denoted J^\pm . We set $J := J^+ \cup J^-$.

If $\mathcal{O} \subset \mathbb{R}^{1,3}$, its *causal shadow* is defined as $J(\mathcal{O}) := \mathcal{O} + J$. We also define its *future/past shadow* $J^\pm(\mathcal{O}) := \mathcal{O} + J^\pm$.

Let $\mathcal{O}_i \subset \mathbb{R}^{1,3}$, $i = 1, 2$. We will write $\mathcal{O}_1 \times \mathcal{O}_2$ iff $J(\mathcal{O}_1) \cap \mathcal{O}_2 = \emptyset$, or equivalently, $\mathcal{O}_1 \cap J(\mathcal{O}_2) = \emptyset$. We then say that \mathcal{O}_1 and \mathcal{O}_2 are *spatially separated*.

A function on $\mathbb{R}^{1,3}$ is called *space-compact* iff there exists a compact $K \subset \mathbb{R}^{1,3}$ such that $\text{supp} f \subset J(K)$. It is called *future/past space-compact* iff there exists a compact $K \subset \mathbb{R}^{1,3}$ such that $\text{supp} f \subset J^\pm(K)$.

The set of space-compact smooth functions will be denoted $C_{\text{sc}}^\infty(\mathbb{R}^{1,3})$. The set of future/past space-compact smooth functions will be denoted $C_{\pm\text{sc}}^\infty(\mathbb{R}^{1,3})$.

1.1.3 Fourier transform

The definition of the Fourier transform of $\mathbb{R}^3 \ni \vec{x} \mapsto f(\vec{x})$ will be standard:

$$\mathcal{F}f(\vec{k}) := \int e^{-i\vec{k}\cdot\vec{x}} f(\vec{x}) d\vec{x}.$$

Often, we will drop \mathcal{F} – the name of the variable will indicate whether we use the position or momentum representation:

$$f(\vec{k}) = \int e^{-i\vec{k}\cdot\vec{x}} f(\vec{x}) d\vec{x}, \quad f(\vec{x}) = \frac{1}{(2\pi)^3} \int e^{i\vec{k}\cdot\vec{x}} f(\vec{k}) d\vec{k}.$$

For the time variable (typically t) we reverse the sign in the Fourier transform:

$$f(\varepsilon) = \int e^{i\varepsilon t} f(t) dt, \quad f(t) = \frac{1}{2\pi} \int e^{-i\varepsilon t} f(\varepsilon) d\varepsilon.$$

1.1.4 Lorentz and Poincaré groups

The pseudo-Euclidean group $O(1, 3)$ is called the *full Lorentz group*. Its connected component of unity is denoted $SO^\uparrow(1, 3)$ and called the *connected Lorentz group*.

The full Lorentz group contains special elements: the time reversal T and the space inversion (the parity) P and the space-time inversion $X := PT$:

$$T(x^0, \vec{x}) = (-x^0, \vec{x}), \quad P(x^0, \vec{x}) = (x^0, -\vec{x}), \quad Xx = -x.$$

It consists of four connected components

$$SO^\uparrow(1, 3), \quad T \cdot SO^\uparrow(1, 3), \quad P \cdot SO^\uparrow(1, 3), \quad X \cdot SO^\uparrow(1, 3).$$

$O(1, 3)$ has three subgroups of index two: the *special Lorentz group* (preserving the spacetime orientation), the *orthochronous Lorentz group* (preserving the forward light cone) and the *chiral Lorentz group* (preserving the parity):

$$SO(1, 3) = SO^\uparrow(1, 3) \cup X \cdot SO^\uparrow(1, 3), \quad (1.1)$$

$$O^\uparrow(1, 3) = SO^\uparrow(1, 3) \cup P \cdot SO^\uparrow(1, 3), \quad (1.2)$$

$$O^{\text{chir}}(1, 3) = SO^\uparrow(1, 3) \cup T \cdot SO^\uparrow(1, 3). \quad (1.3)$$

The affine extension of the full Lorentz group $\mathbb{R}^{1,3} \rtimes O(1, 3)$ is called the *full Poincaré group*. Its elements will be typically written as (y, Λ) . We will often write y instead of $(y, \mathbb{1})$ and Λ instead of $(0, \Lambda)$. It is the full symmetry group of the Minkowski space.

Quantum field theory models are often not invariant wrt the full Poincaré group but one of its subgroups: the *connected*, *special*, *orthochronous* or *chiral Poincaré group*, which have the obvious definitions.

1.1.5 Double coverings of Lorentz and Poincaré groups

The full Poincaré group or one of its subgroups discussed above is sufficient to describe spacetime symmetries on the level observables. On the level of the Hilbert space one needs to replace it by one of its double coverings.

There exists a unique, up to an isomorphism, connected group $Spin^\uparrow(1, 3)$ such that the following short exact sequence is true:

$$\mathbb{1} \rightarrow \mathbb{Z}_2 \rightarrow Spin^\uparrow(1, 3) \rightarrow SO^\uparrow(1, 3) \rightarrow \mathbb{1}. \quad (1.4)$$

We say that $Spin^\uparrow(1, 3)$ is a *connected double covering of $SO^\uparrow(1, 3)$* . The group $Spin^\uparrow(1, 3)$ happens to be isomorphic to $SL(2, \mathbb{C})$.

Unfortunately, the theory of double coverings of the group $O(1, 3)$ is relatively complicated. $O(1, 3)$ has 8 non-isomorphic double coverings that extend (1.4), that is groups G such that the following diagram with exact rows and columns commutes:

$$\begin{array}{ccccccc}
& & \mathbb{1} & & \mathbb{1} & & \mathbb{1} \\
& & \downarrow & & \downarrow & & \downarrow \\
\mathbb{1} & \rightarrow & \mathbb{Z}_2 & \rightarrow & Spin^\uparrow(1, 3) & \rightarrow & SO^\uparrow(1, 3) & \rightarrow & \mathbb{1} \\
& & \downarrow & & \downarrow & & \downarrow & & \\
\mathbb{1} & \rightarrow & \mathbb{Z}_2 & \rightarrow & G & \rightarrow & O(1, 3) & \rightarrow & \mathbb{1}, \\
& & \downarrow & & \downarrow & & \downarrow & & \\
& & \mathbb{1} & \rightarrow & \mathbb{Z}_2 \times \mathbb{Z}_2 & \rightarrow & \mathbb{Z}_2 \times \mathbb{Z}_2 & \rightarrow & \mathbb{1} \\
& & & & \downarrow & & \downarrow & & \\
& & & & \mathbb{1} & & \mathbb{1} & &
\end{array} \tag{1.5}$$

([52] Sect. 3.10). Indeed, let us fix elements \tilde{P} , \tilde{T} and \tilde{X} that cover P , T , X . We can independently demand that

$$\tilde{P}^2 = \pm \mathbb{1}, \quad \tilde{T}^2 = \pm \mathbb{1}, \quad \tilde{X}^2 = \pm \mathbb{1}. \tag{1.6}$$

To obtain these double coverings we need to take the group G generated by $Spin^\uparrow(1, 3)$ and \tilde{P} , \tilde{T} and \tilde{X} with the relations (1.6) and $\tilde{X} := \tilde{P}\tilde{T}$. (This defines (1.5) uniquely). Clearly, (1.6) gives $2 \cdot 2 \cdot 2 = 8$ possibilities.

Among them one has two distinguished double coverings $G = Pin_\pm(1, 3)$ with the relations

$$\tilde{T}_\pm^2 = \pm \mathbb{1}, \quad \tilde{P}_\pm^2 = \pm \mathbb{1}, \quad \tilde{X}_\pm^2 = -\mathbb{1}.$$

The elements \tilde{P}_\pm , \tilde{T}_\pm and \tilde{X}_\pm anticommute among themselves. In what follows we will drop \pm from \tilde{P}_\pm , \tilde{T}_\pm and \tilde{X}_\pm .

Later on we will need the homomorphism $\theta : Pin_\pm(1, 3) \rightarrow \mathbb{Z}_2 = \{1, -1\}$, which is $\theta(\tilde{\Lambda}) = 1$ for orthochronous $\tilde{\Lambda}$ and $\theta(\tilde{\Lambda}) = -1$ for non-orthochronous $\tilde{\Lambda}$. It is called the *time orientation*.

Each group (1.1), (1.2) and (1.3) has two non-isomorphic double coverings extending (1.4). In particular, we have

$$\begin{array}{ccccccc}
& & \mathbb{1} & & \mathbb{1} & & \mathbb{1} \\
& & \downarrow & & \downarrow & & \downarrow \\
\mathbb{1} & \rightarrow & \mathbb{Z}_2 & \rightarrow & Spin^\uparrow(1, 3) & \rightarrow & SO^\uparrow(1, 3) & \rightarrow & \mathbb{1} \\
& & \downarrow & & \downarrow & & \downarrow & & \\
\mathbb{1} & \rightarrow & \mathbb{Z}_2 & \rightarrow & Spin(1, 3) & \rightarrow & SO(1, 3) & \rightarrow & \mathbb{1}, \\
& & \downarrow & & \downarrow & & \downarrow & & \\
& & \mathbb{1} & \rightarrow & \mathbb{Z}_2 & \rightarrow & \mathbb{Z}_2 & \rightarrow & \mathbb{1} \\
& & & & \downarrow & & \downarrow & & \\
& & & & \mathbb{1} & & \mathbb{1} & &
\end{array} \tag{1.7}$$

The group $Spin(1,3)$ is contained in both $Pin_+(1,3)$ and $Pin_-(1,3)$. It is obtained from $Spin^\uparrow(1,3)$ by adjoining \tilde{X} satisfying $\tilde{X}^2 = -\mathbb{1}$. (The other double covering, obtained by adjoining \tilde{X} satisfying $\tilde{X}^2 = \mathbb{1}$ will not play a role in our considerations).

We also have two double coverings of $O^\uparrow(1,3)$ extending (1.4), one contained in $Pin_+(1,3)$, the other in $Pin_-(1,3)$:

$$\begin{array}{ccccccccc}
& & \mathbb{1} & & \mathbb{1} & & \mathbb{1} & & \\
& & \downarrow & & \downarrow & & \downarrow & & \\
\mathbb{1} & \rightarrow & \mathbb{Z}_2 & \rightarrow & Spin^\uparrow(1,3) & \rightarrow & SO^\uparrow(1,3) & \rightarrow & \mathbb{1} \\
& & \downarrow & & \downarrow & & \downarrow & & \\
\mathbb{1} & \rightarrow & \mathbb{Z}_2 & \rightarrow & Pin_\pm^\uparrow(1,3) & \rightarrow & O^\uparrow(1,3) & \rightarrow & \mathbb{1}, \\
& & \downarrow & & \downarrow & & \downarrow & & \\
& & \mathbb{1} & \rightarrow & \mathbb{Z}_2 & \rightarrow & \mathbb{Z}_2 & \rightarrow & \mathbb{1} \\
& & & & \downarrow & & \downarrow & & \\
& & & & \mathbb{1} & & \mathbb{1} & &
\end{array} \tag{1.8}$$

$Pin_\pm^\uparrow(1,3)$ is obtained by adjoining \tilde{P} satisfying $\tilde{P}^2 = \pm\mathbb{1}$.

Finally, we have two double coverings of $O^{\text{chir}}(1,3)$ extending (1.4), one contained in $Pin_+(1,3)$, the other in $Pin_-(1,3)$:

$$\begin{array}{ccccccccc}
& & \mathbb{1} & & \mathbb{1} & & \mathbb{1} & & \\
& & \downarrow & & \downarrow & & \downarrow & & \\
\mathbb{1} & \rightarrow & \mathbb{Z}_2 & \rightarrow & Spin^\uparrow(1,3) & \rightarrow & SO^\uparrow(1,3) & \rightarrow & \mathbb{1} \\
& & \downarrow & & \downarrow & & \downarrow & & \\
\mathbb{1} & \rightarrow & \mathbb{Z}_2 & \rightarrow & Pin_\pm^{\text{chir}}(1,3) & \rightarrow & O^{\text{chir}}(1,3) & \rightarrow & \mathbb{1}, \\
& & \downarrow & & \downarrow & & \downarrow & & \\
& & \mathbb{1} & \rightarrow & \mathbb{Z}_2 & \rightarrow & \mathbb{Z}_2 & \rightarrow & \mathbb{1} \\
& & & & \downarrow & & \downarrow & & \\
& & & & \mathbb{1} & & \mathbb{1} & &
\end{array} \tag{1.9}$$

$Pin_\pm^{\text{chir}}(1,3)$ is obtained by adjoining \tilde{T} satisfying $\tilde{T}^2 = \pm\mathbb{1}$.

Clearly, $\mathbb{R}^{1,3} \rtimes Pin_\pm(1,3)$ is a double covering of the full Poincaré group. Its elements will be often written as $(y, \tilde{\Lambda})$ and then the corresponding element of $\mathbb{R}^{1,3} \rtimes O(1,3)$ will be denoted by (y, Λ) .

1.1.6 Complex Lorentz groups

The complexification of $Spin^\uparrow(1,3)$ is called $Spin(4, \mathbb{C})$. It is a connected group isomorphic to $SL(2, \mathbb{C}) \times SL(2, \mathbb{C})$. We have the embedding

$$Spin^\uparrow(1,3) \simeq SL(2, \mathbb{C}) \ni \tilde{\Lambda} \mapsto (\tilde{\Lambda}, \overline{\tilde{\Lambda}}) \in SL(2, \mathbb{C}) \times SL(2, \mathbb{C}) \simeq Spin(4, \mathbb{C}).$$

The group $Spin(1,3)$ is contained in $Spin(4, \mathbb{C})$. In particular, the two elements covering the spacetime inversion are represented as follows:

$$\begin{aligned}
Spin(1,3) \ni \tilde{X} &\mapsto (\mathbb{1}, -\mathbb{1}) \in Spin(4, \mathbb{C}), \\
Spin(1,3) \ni -\tilde{X} &\mapsto (-\mathbb{1}, \mathbb{1}) \in Spin(4, \mathbb{C}).
\end{aligned}$$

Every finite dimensional representation of $Spin^\uparrow(1,3)$ extends uniquely by holomorphic continuation to a representation of the connected complex group $Spin(4, \mathbb{C})$. This representation can be restricted to a representation of $Spin(1,3)$. Thus every finite dimensional representation of $Spin^\uparrow(1,3)$ has a natural extension to a representation of $Spin(1,3)$.

The complexification of $Pin_-(1,3)$ coincides with the complexification of $Pin_+(1,3)$. It is denoted $Pin(4, \mathbb{C})$.

It will also be useful to introduce a group that we will call $Pin_{\text{ext}}(1,3)$. It is the real subgroup of $Pin(4, \mathbb{C})$ that is generated by $Pin_-(1,3)$ and $i\mathbb{1}$, and also by $Pin_+(1,3)$ and $i\mathbb{1}$. We have

$$\begin{array}{ccccccc}
& & \mathbb{1} & & \mathbb{1} & & \mathbb{1} \\
& & \downarrow & & \downarrow & & \downarrow \\
\mathbb{1} & \rightarrow & \mathbb{Z}_2 & \rightarrow & Spin^\uparrow(1,3) & \rightarrow & SO^\uparrow(1,3) & \rightarrow & \mathbb{1} \\
& & \downarrow & & \downarrow & & \downarrow & & \\
\mathbb{1} & \rightarrow & \mathbb{Z}_4 & \rightarrow & Pin_{\text{ext}}(1,3) & \rightarrow & O(1,3) & \rightarrow & \mathbb{1} \\
& & \downarrow & & \downarrow & & \downarrow & & \\
\mathbb{1} & \rightarrow & \mathbb{Z}_2 & \rightarrow & \mathbb{Z}_2 \times \mathbb{Z}_2 \times \mathbb{Z}_2 & \rightarrow & \mathbb{Z}_2 \times \mathbb{Z}_2 & \rightarrow & \mathbb{1} \\
& & \downarrow & & \downarrow & & \downarrow & & \\
& & \mathbb{1} & & \mathbb{1} & & \mathbb{1} & &
\end{array} \tag{1.10}$$

1.2 General concepts of quantum field theory

1.2.1 Quantum mechanics

Pure quantum states are described by normalized vectors in a Hilbert space. In typical situations the dynamics is generated by a bounded from below self-adjoint operator called the *Hamiltonian*. It does not affect any physical predictions if we subtract from the Hamiltonian the infimum of its spectrum. The Hamiltonian has often a ground state. The ground state is typically nondegenerate.

It will be convenient to formalize these properties.

Definition 1.1 *We will say that \mathcal{H}, H, Ω satisfy the standard requirements of quantum mechanics (QM) if*

- (1) \mathcal{H} is a Hilbert space;
- (2) H is a positive self-adjoint operator on \mathcal{H} (called the Hamiltonian);
- (3) Ω is a normalized eigenvector of H with eigenvalue 0;
- (4) Ω is nondegenerate as an eigenvector of H .

1.2.2 Time reversal

If R is a unitary operator R reversing the time, that is, satisfying

$$R e^{-itH} R^{-1} = e^{itH},$$

then $RHR^{-1} = -H$. Therefore, if H is positive, then $H = 0$. Hence unitary operators are not appropriate for the time reversal invariance.

Following Wigner, by a *time reversal* operator we will mean an anti-unitary operator T satisfying

$$Te^{-itH}T^{-1} = e^{itH}.$$

We have then $THT^{-1} = H$, which is compatible with the positivity of H .

Let us review some concepts and notation related to linear and especially anti-linear operators, motivated by their applications as Wigner's time reversal. Consider the complex vector space $\mathcal{W} = \mathbb{C}^n$. Let ρ be a linear operator on \mathcal{W} . Then there exists a matrix $[\rho_{ab}]$ such that

$$(\rho w)_a = \sum_b \rho_{ab} w_b, \quad (1.11)$$

where $w = [w_a] \in \mathcal{W}$. We will call $[\rho_{ab}]$ the *matrix of ρ* . Note that it is natural to denote the operator and its matrix by the same symbol. In particular, the matrix of the product of linear operators is simply the product of their matrices.

Let κ be an antilinear operator on \mathcal{W} . Then there exists a matrix $[\kappa_{ab}]$ such that

$$(\kappa w)_a = \sum_b \kappa_{ab} \bar{w}_b, \quad (1.12)$$

where, as usual, the bar denotes the complex conjugation. We will say that $[\kappa_{ab}]$ is the *matrix of κ* . Unfortunately, it is dangerous to use the same letter for an antilinear operator and its matrix, even if we will sometimes do so, as in (1.12). The matrix of the product of two antilinear operators is in general not the product of their matrices – one needs to put the bar in an appropriate place.

Sometimes it will be convenient to denote linear transformations on \mathcal{W} by $L_1(\mathcal{W})$ instead of the usual $L(\mathcal{W})$. Then antilinear transformations will be denoted by $L_{-1}(\mathcal{W})$.

Let G be a group equipped with a homomorphism $\theta : G \rightarrow \mathbb{Z}_2 = \{1, -1\}$. It yields an obvious partition of G :

$$G = G_1 \cup G_{-1}.$$

We will say that $G \ni g \mapsto \pi(g)$ is a θ -*linear* representation on \mathcal{W} if we have a pair of maps

$$G_1 \ni g \mapsto \pi(g) \in L_1(\mathcal{W}), \quad (1.13)$$

$$G_{-1} \ni g \mapsto \pi(g) \in L_{-1}(\mathcal{W}), \quad (1.14)$$

which together form a representation of G . One can write (1.13) and (1.14) more compactly:

$$G \ni g \mapsto \pi(g) \in L_{\theta(g)}(\mathcal{W}). \quad (1.15)$$

Suppose that \mathcal{W} is equipped with a scalar product. Sometimes it will be convenient to denote unitary transformations on \mathcal{W} by $U_1(\mathcal{W})$ instead of the

usual $U(\mathcal{W})$. Then anti-unitary transformations will be denoted by $U_{-1}(\mathcal{W})$. We say that $G \ni g \mapsto \pi(g)$ is a θ -unitary representation on \mathcal{W} if we have a pair of maps

$$G_1 \ni g \mapsto \pi(g) \in U_1(\mathcal{W}), \quad (1.16)$$

$$G_{-1} \ni g \mapsto \pi(g) \in U_{-1}(\mathcal{W}), \quad (1.17)$$

which together form a representation of G . Again, (1.16) and (1.17) can be written more compactly:

$$G \ni g \mapsto \pi(g) \in U_{\theta(g)}(\mathcal{W}). \quad (1.18)$$

1.2.3 Relativistic quantum mechanics

Relativistic covariance of a quantum system described by a Hilbert space \mathcal{H} is expressed by choosing a strongly continuous unitary representation of the double cover of the connected Poincaré group

$$\mathbb{R}^{1,3} \rtimes Spin^\uparrow(1,3) \ni (y, \tilde{\Lambda}) \mapsto U(y, \tilde{\Lambda}) \in U(\mathcal{H}). \quad (1.19)$$

We will denote the self-adjoint generator of space-time translations by $P = (P^0, \vec{P})$. $P^0 = H$ is the *Hamiltonian*. \vec{P} is called the *momentum*. Thus

$$U((t, \vec{y}), \mathbb{1}) = e^{-itH + i\vec{y}\vec{P}}.$$

(We assume that the Planck constant \hbar equals 1).

Representations of $Spin^\uparrow(1,3)$ can be divided into two categories. Integer spin representations induce a representation of $SO^\uparrow(1,3)$, and half-integer representations do not. The projections

$$\frac{1}{2}(\mathbb{1} + U(0, -\mathbb{1})), \text{ resp. } \frac{1}{2}(\mathbb{1} - U(0, -\mathbb{1}))$$

project onto the spaces of representations of integer, resp. half-integer spin. We will write

$$I := U(0, -\mathbb{1}).$$

Obviously, $PI = IP$. Anticipating the connection of spin and statistics we will call I the *fermionic parity*. Denote the *-automorphism defined by $U(y, \tilde{\Lambda})$ by $\mathcal{U}_{(y, \tilde{\Lambda})}$

$$\mathcal{U}_{(y, \tilde{\Lambda})}(A) := U(y, \tilde{\Lambda})AU(y, \tilde{\Lambda})^*.$$

Restricted to the commutant of I

$$\{I\}' := \{A \in B(\mathcal{H}) : IA = AI\}$$

$\mathcal{U}_{(y, \tilde{\Lambda})} = \mathcal{U}_{(y, -\tilde{\Lambda})}$, and thus we obtain a representation of the Poincaré group:

$$\mathbb{R}^{1,3} \rtimes SO^\uparrow(1,3) \ni (y, \Lambda) \mapsto \mathcal{U}_{(y, \Lambda)} \in \text{Aut}(\{I\}').$$

Definition 1.2 *The following conditions will be called the basic requirements of relativistic quantum mechanics (RQM):*

- (1) Existence of a Poincaré invariant vacuum: *There exists a (normalized) vector Ω invariant with respect to $\mathbb{R}^{1,3} \rtimes Spin^\uparrow(1,3)$.*
- (2) Spectral condition: *The joint spectrum of the energy-momentum operator is contained in the forward light cone, that is, $sp(P) \subset J^+$.*
- (3) Uniqueness of the vacuum: *The vector Ω is unique up to a phase factor.*
- (4) Integer and half-integer spin states live in separate superselection sectors: *Observables are contained in $\{I\}'$.*

Note that conditions (1)-(3) imply the standard requirements of QM.

More precisely, (2) implies $H \geq 0$. Conversely, the Poincaré invariance and the boundedness from below of H implies (2).

(2) implies also that Ω is the *ground state* of H . (3) implies that this ground state is unique.

Obviously, $I\Omega = \Omega$.

Remark 1.3 *Sometimes the expression relativistic quantum mechanics is used for the theory of relativistic linear hyperbolic equations, such as the Klein-Gordon and Dirac equation. For the Klein-Gordon equation this is certainly incorrect. This is a classical equation – in particular, it does not have a natural interpretation in terms of a unitary dynamics on a Hilbert space. In our terminology Dirac equation is also a classical equation – its unitary dynamics is non-physical because the Hamiltonian is unbounded from below.*

1.2.4 Haag-Kastler axioms for observable algebras

We still need some postulates that express the idea of causality. In the mathematical physics literature one can find two kinds of axioms that try to formalize this concept: the *Haag-Kastler* and the *Wightman axioms*. Even though the Wightman axioms were formulated earlier, it is more natural to start with the Haag-Kastler axioms.

Definition 1.4 *We keep the basic requirements of RQM.*

In addition, to each open bounded set $\mathcal{O} \subset \mathbb{R}^{1,3}$ we associate a von Neumann algebra $\mathfrak{A}(\mathcal{O}) \subset \{I\}'$. We will say that the family $\mathfrak{A}(\mathcal{O})$, \mathcal{O} open in $\mathbb{R}^{1,3}$, is a net of observable algebras satisfying the Haag-Kastler axioms if the following conditions hold:

- (1) Isotony: $\mathcal{O}_1 \subset \mathcal{O}_2$ implies $\mathfrak{A}(\mathcal{O}_1) \subset \mathfrak{A}(\mathcal{O}_2)$.
- (2) Poincaré covariance: for $(y, \tilde{\Lambda}) \in \mathbb{R}^{1,3} \rtimes Spin^\uparrow(1,3)$, we have

$$\mathcal{U}_{(y, \tilde{\Lambda})}(\mathfrak{A}(\mathcal{O})) = \mathfrak{A}((y, \Lambda)\mathcal{O}).$$

- (3) Einstein causality: Let $\mathcal{O}_1 \times \mathcal{O}_2$. Then

$$A_i \in \mathfrak{A}(\mathcal{O}_i), \quad i = 1, 2, \quad \text{implies } A_1 A_2 = A_2 A_1.$$

Self-adjoint elements of the algebras $\mathfrak{A}(\mathcal{O})$ are supposed to describe *observables* in \mathcal{O} . This means that in principle an observer contained in \mathcal{O} can perturb the dynamics by a self-adjoint operator from $\mathfrak{A}(\mathcal{O})$, and only from $\mathfrak{A}(\mathcal{O})$.

Remark 1.5 *One can ask why von Neumann algebras are used in the Haag-Kastler axioms to describe sets of observables. We would like to argue that it is a natural choice.*

Suppose we weaken the Haag-Kastler axioms as follows: We replace the family of von Neumann algebras $\mathfrak{A}(\mathcal{O})$ by arbitrary sets $\mathfrak{B}(\mathcal{O})$ of self-adjoint elements of $B(\mathcal{H})$, and otherwise we keep the axioms unchanged. Then, if we set $\mathfrak{A}(\mathcal{O}) := \mathfrak{B}(\mathcal{O})''$ (which obviously contain $\mathfrak{B}(\mathcal{O})$), we obtain a family of von Neumann algebras satisfying the usual Haag-Kastler axioms. In particular, to see that the Einstein causality still holds, we use the following easy fact:

Let $\mathfrak{B}_1, \mathfrak{B}_2$, be two $$ -invariant subsets of $B(\mathcal{H})$ such that*

$$A_1 \in \mathfrak{B}_1, A_2 \in \mathfrak{B}_2 \quad \text{implies} \quad A_1 A_2 = A_2 A_1.$$

Set $\mathfrak{A}_1 := \mathfrak{B}_1'', \mathfrak{A}_2 := \mathfrak{B}_2''$. Then

$$A_1 \in \mathfrak{A}_1, A_2 \in \mathfrak{A}_2 \quad \text{implies} \quad A_1 A_2 = A_2 A_1.$$

1.2.5 Haag-Kastler axioms for field algebras

It is often natural to consider nets of algebras containing not only observables, but also other operators that can be useful to construct observables. They are called *field algebras* and satisfy a slightly modified version of Haag-Kastler axioms.

Definition 1.6 *We assume the basic requirements of RQM. We say that a family of von Neumann algebras $\mathfrak{F}(\mathcal{O}) \subset B(\mathcal{H})$ associated to bounded open subsets \mathcal{O} of $\mathbb{R}^{1,3}$ is a net of field algebras in the sense of Haag-Kastler axioms if the following conditions hold:*

(1)' *Isotony: $\mathcal{O}_1 \subset \mathcal{O}_2$ implies $\mathfrak{F}(\mathcal{O}_1) \subset \mathfrak{F}(\mathcal{O}_2)$.*

(2)' *Poincaré covariance: for $(y, \tilde{\Lambda}) \in \mathbb{R}^{1,3} \times Spin^\uparrow(1,3)$, we have*

$$\mathcal{U}_{(y, \tilde{\Lambda})}(\mathfrak{F}(\mathcal{O})) = \mathfrak{F}((y, \Lambda)\mathcal{O}).$$

(3)' *Twisted Einstein causality. Let $\mathcal{O}_1 \times \mathcal{O}_2$. Then*

$$A_i \in \mathfrak{F}(\mathcal{O}_i), A_i = (-1)^{j_i} I A_i I, \quad i = 1, 2, \quad \text{implies} \quad A_1 A_2 = (-1)^{j_1 j_2} A_2 A_1.$$

(4)' *Cyclicity: $\left(\bigcup_{\mathcal{O}} \mathfrak{F}(\mathcal{O})\right)\Omega$ is dense in \mathcal{H} .*

The main reason for introducing the twisted Einstein causality is the need to accommodate anticommuting fermionic fields. Clearly, if the net $\mathfrak{F}(\mathcal{O})$, $\mathcal{O} \subset$

$\mathbb{R}^{1,3}$ satisfies the Haag-Kastler axioms for field algebras, then the net of their *fermionic even subalgebras*

$$\mathfrak{F}_0(\mathcal{O}) := \{B \in \mathfrak{F}(\mathcal{O}) : IBI = B\}, \quad \mathcal{O} \subset \mathbb{R}^{1,3},$$

satisfies the Haag-Kastler axioms for observable algebras.

Note that in our formulation the decomposition $\mathcal{H} = \mathcal{H}_0 \oplus \mathcal{H}_1$ given by the operator I plays a double role.

- (1) It describes the decomposition of the Hilbert space into integer and half-integer spin representations.
- (2) In the Einstein causality axiom, block-diagonal operators have the bosonic character and block-off-diagonal operators have the fermionic character.

A priori it is not obvious that these two properties should give the same decomposition. However, one can show that it is natural to assume from the beginning that this is the case. This is the content the theorem about the *connection of the spin and statistics*, described eg. in [53].

Setting $\tilde{\Lambda} = -\mathbb{1}$ in Axiom (2)' shows that the bosonic/fermionic superselection rule is local, ie., $I\mathfrak{F}(\mathcal{O})I = \mathfrak{F}(\mathcal{O})$ for all \mathcal{O} .

1.2.6 Global symmetries

Field algebras can be used to describe *global symmetries*.

Suppose that a group G has a unitary representation on the Hilbert \mathcal{H} :

$$G \ni g \mapsto R(g) \in U(\mathcal{H})$$

We assume that $R(g)$, $g \in G$, commute with $U(y, \tilde{\Lambda})$ and leave invariant Ω . This implies that I commutes with $R(g)$. Let \mathcal{R}_g denote the automorphism defined by $R(g)$:

$$\mathcal{R}_g(A) := R(g)AR(g)^{-1}, \quad A \in B(\mathcal{H}).$$

We define the *gauge invariant subalgebras*

$$\mathfrak{F}_{\text{gi}}(\mathcal{O}) = \{B \in \mathfrak{F}_0(\mathcal{O}) : \mathcal{R}_g(B) = B, \quad g \in G\}$$

or, equivalently,

$$\mathfrak{F}_{\text{gi}}(\mathcal{O}) = \mathfrak{F}_0(\mathcal{O}) \cap \{R(g) : g \in G\}'.$$

Then the net $\mathcal{O} \mapsto \mathfrak{F}_{\text{gi}}(\mathcal{O})$ satisfies then the Haag-Kastler axioms for observable algebras.

1.2.7 Neutral quantum fields

In practical computations of quantum field theory the information is encoded in *quantum fields*. Some of these fields are (formally) Hermitian, and then they are called *neutral fields*. Some of them are not – they are usually called *charged fields*. We will first consider only neutral fields. Charged fields will be discussed later.

Neutral fields are typically denoted by $\mathbb{R}^{1,3} \ni x \mapsto \hat{\phi}_a(x)$, where $a = 1, \dots, n$ enumerates the “internal degrees of freedom”, eg. the species of particles and the value of their spin projected on a distinguished axis. Some of the fields are bosonic, some are fermionic. They commute or anticommute for spatially separated points, which is expressed by the commutation/anticommutation relations

$$[\hat{\phi}_a(x), \hat{\phi}_b(y)]_{\pm} = 0, \quad (x - y)^2 > 0.$$

One can try to interpret neutral quantum fields as “operator valued tempered distributions”, which become (possibly unbounded) self-adjoint operators when smeared out with real Schwartz test functions. We can organize the internal degrees of freedom of neutral fields into a finite dimensional vector space $\mathcal{V} = \mathbb{R}^n$. Thus for any $f = (f_a) \in \mathcal{S}(\mathbb{R}^{1,3}, \mathbb{R}^n)$ we obtain a *smeared out quantum field*, which is the operator

$$\hat{\phi}[f] := \sum_a \int f_a(x) \hat{\phi}_a(x) dx. \quad (1.20)$$

1.2.8 Wightman axioms for neutral fields

Let us now formulate the Wightman axioms for neutral fields.

Definition 1.7 *We assume that the basic requirements of RQM are satisfied.*

\mathcal{V} is a finite dimensional real vector space equipped with a representation

$$Spin^\uparrow(1, 3) \ni \tilde{\Lambda} \mapsto \sigma(\tilde{\Lambda}) \in L(\mathcal{V}). \quad (1.21)$$

We have a unique decomposition $\mathcal{V} = \mathcal{V}_0 \oplus \mathcal{V}_1$. where \mathcal{V}_0 , resp. \mathcal{V}_1 is the space of integer spin, resp. half-integer spin.

We suppose that \mathcal{D} is a dense subspace of \mathcal{H} containing Ω and we have a map

$$\mathcal{S}(\mathbb{R}^{1,3}, \mathcal{V}) \ni f \mapsto \hat{\phi}[f] \in L(\mathcal{D}) \quad (1.22)$$

satisfying the following conditions:

- (1) *Continuity: For any $\Phi, \Psi \in \mathcal{D}$,*

$$\mathcal{S}(\mathbb{R}^{1,3}, \mathcal{V}) \ni f \mapsto (\Phi | \hat{\phi}[f] \Psi) \quad (1.23)$$

is continuous.

- (2) *Poincaré covariance: for $(y, \tilde{\Lambda}) \in \mathbb{R}^{1,3} \times Spin^\uparrow(1, 3)$ we have*

$$\mathcal{U}_{(y, \tilde{\Lambda})}(\hat{\phi}[f]) = \hat{\phi} \left[\sigma(\tilde{\Lambda}) f \circ (y, \Lambda)^{-1} \right].$$

- (3) *Einstein causality: Let $\text{supp} f_1 \times \text{supp} f_2 = \emptyset$, where f_i have values in \mathcal{V}_{j_i} , $i = 1, 2$. Then*

$$\hat{\phi}[f_1] \hat{\phi}[f_2] = (-1)^{j_1 j_2} \hat{\phi}[f_2] \hat{\phi}[f_1].$$

- (4) *Cyclicity of the vacuum: Let $\mathfrak{F}^{\text{alg}}$ denote the algebra of polynomials generated by $\hat{\phi}[f]$. Then $\mathfrak{F}^{\text{alg}} \Omega$ is dense in \mathcal{H} .*

(5) Hermiticity: For any $\Phi, \Psi \in \mathcal{D}$,

$$(\Phi | \hat{\phi}[f] \Psi) = (\hat{\phi}[f] \Phi | \Psi).$$

In what follows a map (1.22) satisfying Axiom (1) will be called an *operator valued distribution*. By saying that it is cyclic we will mean that it satisfies Axiom (4).

Setting $\tilde{\Lambda} = -\mathbb{1}$ in Axiom (2), we see that $f \in \mathcal{S}(\mathbb{R}^{1,3}, \mathcal{V}_j)$ implies

$$\hat{\phi}[f] = (-1)^j I \hat{\phi}[f] I.$$

1.2.9 Relationship between Haag-Kastler and Wightman axioms

“Morally”, Wightman axioms are stronger than the Haag-Kastler axioms. In fact, let $\mathfrak{F}^{\text{alg}}(\mathcal{O})$ be the algebra of polynomials in $\hat{\phi}[f]$ with $\text{supp} f \subset \mathcal{O}$, which can be treated as a $*$ -subalgebra of $L(\mathcal{D})$. Then the family $\mathcal{O} \mapsto \mathfrak{F}^{\text{alg}}(\mathcal{O})$ is almost a net of field algebras and $\mathcal{O} \mapsto \mathfrak{F}_0^{\text{alg}}(\mathcal{O})$ is almost a net of observable algebras in the sense of the Haag-Kastler axioms. Unfortunately, elements of $\mathfrak{F}^{\text{alg}}(\mathcal{O})$ are defined only on \mathcal{D} and not on the whole \mathcal{H} , and often do not extend to bounded operators on \mathcal{H} .

We know that the fields $\hat{\phi}[f]$ are *Hermitian* on \mathcal{D} . Suppose they are *essentially self-adjoint*. Then their closures are self-adjoint operators on \mathcal{H} . We could consider the von Neumann algebra $\mathfrak{F}(\mathcal{O})$ generated by bounded functions of $\hat{\phi}[f]$, $\text{supp} f \subset \mathcal{O}$. Let $\mathfrak{F}_0(\mathcal{O})$ be its fermionic even part. Then there is still no guarantee that the net $\mathcal{O} \mapsto \mathfrak{F}_0(\mathcal{O})$ satisfies the Haag-Kastler axioms: we are not sure whether the Einstein causality holds.

To see this we recall that there are serious problems with commutation of unbounded operators [42]. One says that two self-adjoint operators commute (or strongly commute) if all their spectral projections commute. There exist however examples of pairs of two self-adjoint operators A, B and a subspace $\mathcal{D} \subset \text{Dom} A \cap \text{Dom} B$ with the following property:

- (1) A and B preserve \mathcal{D} and are essentially self-adjoint on \mathcal{D} .
- (2) A and B commute on \mathcal{D} .
- (3) A and B do not commute strongly.
- (4) \mathcal{D} is dense.

More about what is known about the relationship between the Haag-Kastler and Wightman axioms the reader can find in [2], Sect. 4.9.

1.2.10 Global symmetries in the Wightman formalism

In the Wightman formalism we can encode global symmetries. Let G be a group acting with the unitary representation $U(g)$ and let \mathcal{U}_g the corresponding $*$ -automorphism, as described in Subsect. 1.2.6. Suppose in addition that g acts on \mathcal{V} such that $\mathcal{R}_g(\hat{\phi}[f]) := \hat{\phi}[gf]$, or in the unsmearing notation

$$\mathcal{R}_g(\hat{\phi}_a(x)) = \sum_b g_{ab} \hat{\phi}_b(x),$$

where g commutes with $\sigma(\tilde{\Lambda})$.

\mathcal{R}_g can be interpreted as a $*$ -automorphism of the polynomial algebra $\mathfrak{F}^{\text{alg}}$. We set $\mathfrak{F}_{\text{gi}}^{\text{alg}}(\mathcal{O})$ to be the subalgebra of fixed points of the action of G on $\mathfrak{F}_0^{\text{alg}}(\mathcal{O})$. One could argue that this $*$ -algebra should describe observables in \mathcal{O} .

Note that what we described is a *global symmetry* and not a *local gauge invariance*. (In the older literature sometimes the former is called the *gauge invariance of the first kind* and the latter the *gauge invariance of the second kind*). Satisfactory treatment of local gauge invariance, even Abelian, in the framework of Wightman axioms seems to be problematic. In fact, a convenient description of gauge fields seems to require a space with an indefinite scalar product. This goes beyond the usual Wightman axioms and poses serious technical problems [57].

Haag-Kastler axioms seem to provide a satisfactory general framework for quantum field theory on a flat spacetime, also for theories with local gauge invariance. Their weakness is the abstractness and great generality. For instance, we do not see how to recognize that a given family of algebras satisfying Haag-Kastler axioms corresponds to a theory with local gauge invariance. (There exists, however, a beautiful theory developed by Doplicher-Haag-Roberts that allows us to recognize global symmetries.)

Wightman axioms seem more concrete. However, they have flaws. As we mentioned earlier, they seem to be incompatible with the local gauge invariance.

In any case, both Haag-Kastler and Wightman axioms are useful as guiding principles for quantum field theory.

1.2.11 Charged fields

Sometimes, instead of Hermitian fields one uses a pair of fields $\mathbb{R}^{1,3} \ni x \mapsto \hat{\psi}_a(x), \hat{\psi}_a^*(x)$, $a = 1, \dots, m$. We will call them *charged fields*. One assumes that after smearing with complex test functions

$$\begin{aligned}\hat{\psi}[h] &:= \sum_a \int \overline{h_a(x)} \hat{\psi}_a(x) dx, \\ \hat{\psi}^*[h] &:= \sum_a \int h_a(x) \hat{\psi}_a^*(x) dx,\end{aligned}$$

one obtains linear operators on \mathcal{D} Hermitian conjugate to one another.

One can organize species of charged fields into a *complex space* $\mathcal{W} = \mathbb{C}^m$.

Clearly, for any charged field ψ_a , by setting

$$\begin{aligned}\hat{\phi}_{a,\text{R}}(x) &:= \frac{1}{\sqrt{2}}(\hat{\psi}_a(x) + \hat{\psi}_a^*(x)), \\ \hat{\phi}_{a,\text{I}}(x) &:= \frac{1}{i\sqrt{2}}(\hat{\psi}_a(x) - \hat{\psi}_a^*(x))\end{aligned}$$

we obtain a pair of neutral fields. Thus introducing charged fields to the Wightman axioms is essentially only a notational change, which, as we will see, is

convenient for describing $U(1)$ symmetries.

1.2.12 Wightman axioms for neutral and charged fields

The modified Wightman axioms that admits both neutral and charged fields are very similar to the Wightman axioms for neutral fields described in Subsubsection 1.2.8. It would be boring to state them in full detail. In fact, almost all statements from the Wightman axioms for neutral fields remain a part of the new axioms. The only exception is Axiom (4) about the cyclicity of the vacuum, which needs to be replaced by a new one. Below we will list the additional elements that need to be added. We indicate by (...) the places where appropriate statements from Subsubsection 1.2.8 should be inserted.

Definition 1.8 (...) We assume that \mathcal{W} is a finite dimensional complex vector space equipped with a representation

$$\text{Spin}^\uparrow(1,3) \ni \tilde{\Lambda} \mapsto \tau(\tilde{\Lambda}) \in L(\mathcal{W}). \quad (1.24)$$

We have a unique decomposition $\mathcal{W} = \mathcal{W}_0 \oplus \mathcal{W}_1$. where \mathcal{W}_0 , resp. \mathcal{W}_1 is the space of integer spin, resp. half-integer spin.

(...) We have maps

$$\mathcal{S}(\mathbb{R}^{1,3}, \mathcal{W}) \ni h \mapsto \hat{\psi}[h], \hat{\psi}^*[h] \in L(\mathcal{D}). \quad (1.25)$$

(1) Continuity: (...)

$$\mathcal{S}(\mathbb{R}^{1,3}, \mathcal{W}) \ni h \mapsto (\Phi | \hat{\psi}[h] \Psi) \quad (1.26)$$

is continuous.

(2) Poincaré covariance: (...)

$$\mathcal{U}_{(y, \tilde{\Lambda})}(\hat{\psi}[h]) = \hat{\psi} \left[\tau(\tilde{\Lambda})h \circ (y, \Lambda)^{-1} \right].$$

(3) Einstein causality: (...) Let $\text{supp}h_1 \times \text{supp}h_2 = \emptyset$, where h_i have values in \mathcal{W}_{j_i} , $i = 1, 2$. Then (...)

$$\begin{aligned} \hat{\phi}[f_1] \hat{\psi}[h_2] &= (-1)^{j_1 j_2} \hat{\psi}[h_2] \hat{\phi}[f_1], \\ \hat{\psi}[h_1] \hat{\psi}[h_2] &= (-1)^{j_1 j_2} \hat{\psi}[h_2] \hat{\psi}[h_1], \\ \hat{\psi}[h_1] \hat{\psi}^*[h_2] &= (-1)^{j_1 j_2} \hat{\psi}^*[h_2] \hat{\psi}[h_1]. \end{aligned}$$

(4) Cyclicity of the vacuum: Let $\mathfrak{F}^{\text{alg}}$ denote the algebra of polynomials in $\hat{\phi}[f]$, $\hat{\psi}[h]$ and $\hat{\psi}^*[h]$. Then $\mathfrak{F}^{\text{alg}}\Omega$ is dense in \mathcal{H} .

(5) Hermiticity: (...)

$$(\Phi | \hat{\psi}[h] \Psi) = (\hat{\psi}^*[h] \Phi | \Psi).$$

It will be convenient to reformulate the axiom about the Poincaré invariance in terms of the unsmearred fields:

$$\mathcal{U}_{(y, \tilde{\Lambda})}(\hat{\phi}_a(x)) = \sum_b \sigma_{ab}^{-1}(\tilde{\Lambda}) \hat{\phi}_b(\Lambda x + y), \quad (1.27)$$

$$\mathcal{U}_{(y, \tilde{\Lambda})}(\hat{\psi}_a(x)) = \sum_b \tau_{ab}^{-1}(\tilde{\Lambda}) \hat{\psi}_b(\Lambda x + y). \quad (1.28)$$

1.2.13 $U(1)$ symmetry

Consider the group $U(1) = \mathbb{R}/2\pi\mathbb{Z}$. A global $U(1)$ symmetry is usually encoded by dividing fields into neutral $\hat{\phi}$ and complex $\hat{\psi}$. Let \mathcal{H}_n be the closed span of vectors of the form

$$\hat{\phi}[f_1] \cdots \hat{\phi}[f_k] \hat{\psi}^*[h_1] \cdots \hat{\phi}^*[h_p] \hat{\psi}[h'_1] \cdots \hat{\phi}[h'_q] \Omega, \quad n = p - q.$$

Note that the cyclicity of vacuum implies that the sum of \mathcal{H}_n is dense in \mathcal{H} . Assume that \mathcal{H}_n are mutually orthogonal, so that we have the decomposition $\mathcal{H} = \bigoplus_{n \in \mathbb{Z}} \mathcal{H}_n$. For $\theta \in U(1)$ we define $R(\theta) := \bigoplus_{n \in \mathbb{Z}} e^{in\theta}$. Clearly, $R(\theta)\Omega = \Omega$ and $U(1) \ni \theta \mapsto R(\theta)$ is a unitary representation commuting with $U(y, \tilde{\Lambda})$. Let \mathcal{R}_θ be the corresponding *-automorphism:

$$\mathcal{R}_\theta(A) = R(\theta)AR(-\theta).$$

We then have

$$\begin{aligned} \mathcal{R}_\theta(\hat{\phi}_a(x)) &= \hat{\phi}_a(x), \\ \mathcal{R}_\theta(\hat{\psi}_a(x)) &= e^{-i\theta} \hat{\psi}_a(x), \\ \mathcal{R}_\theta(\hat{\psi}_a^*(x)) &= e^{i\theta} \hat{\psi}_a^*(x). \end{aligned}$$

Thus we have an example of a global symmetry, as in Subsect. 1.2.10.

1.2.14 Charge conjugation

Let C be a unitary operator such that $C\Omega = \Omega$. Let \mathcal{C} be the corresponding *-automorphism:

$$\mathcal{C}(A) := CAC^{-1}.$$

We say that it is a *charge conjugation* if it satisfies

$$\mathcal{C}(\hat{\phi}_a(x)) = \sum_b \alpha_{ab}^{-1} \hat{\phi}_b(x), \quad (1.29)$$

$$\mathcal{C}(\hat{\psi}_a(x)) = \sum_b \kappa_{ab}^{-1} \hat{\psi}_b^*(x), \quad (1.30)$$

and hence

$$\mathcal{C}(\hat{\psi}_a^*(x)) = \sum_b \bar{\kappa}_{ab}^{-1} \hat{\psi}_b(x), \quad (1.31)$$

where α and κ are some matrices on \mathcal{V} and \mathcal{W} . We will also assume that

$$\alpha^4 = \mathbb{1}, \quad (\kappa \bar{\kappa})^2 = \mathbb{1}, \quad (1.32)$$

so that $C^4 = \mathbb{1}$.

We have

$$\mathcal{C}\mathcal{R}_\theta = \mathcal{R}_{-\theta}\mathcal{C},$$

which is the reason for the name charge conjugation.

Note that C is linear, even though \mathcal{C} acts on fields antilinearly.

1.2.15 Parity invariance

Recall that the Wightman axioms involve the connected Lorentz group $Spin^\uparrow(1, 3)$. In particular, we have representations

$$Spin^\uparrow(1, 3) \ni \tilde{\Lambda} \mapsto \sigma(\tilde{\Lambda}) \in L(\mathcal{V}), \quad (1.33)$$

$$Spin^\uparrow(1, 3) \ni \tilde{\Lambda} \mapsto \tau(\tilde{\Lambda}) \in L(\mathcal{W}), \quad (1.34)$$

$$\mathbb{R}^{1,3} \rtimes Spin^\uparrow(1, 3) \ni (y, \tilde{\Lambda}) \mapsto U(y, \tilde{\Lambda}) \in U(\mathcal{H}). \quad (1.35)$$

Chose $+$ or $-$. Replace the group $Spin^\uparrow(1, 3)$ in the Wightman axioms by $Pin_\pm^\uparrow(1, 3)$, so that we have the representations

$$Pin_\pm^\uparrow(1, 3) \ni \tilde{\Lambda} \mapsto \sigma(\tilde{\Lambda}) \in L(\mathcal{V}), \quad (1.36)$$

$$Pin_\pm^\uparrow(1, 3) \ni \tilde{\Lambda} \mapsto \tau(\tilde{\Lambda}) \in L(\mathcal{W}), \quad (1.37)$$

$$\mathbb{R}^{1,3} \rtimes Pin_\pm^\uparrow(1, 3) \ni (y, \tilde{\Lambda}) \mapsto U(y, \tilde{\Lambda}) \in U(\mathcal{H}). \quad (1.38)$$

The resulting set of axioms will be called the *Wightman axioms of a P -invariant theory*.

In particular, the space inversion (parity) $\tilde{P} \in Pin_\pm^\uparrow(1, 3)$ is represented in the Hilbert space by the unitary operator $P := U(\tilde{P})$. $\mathcal{P} := \mathcal{U}_{\tilde{P}}$ denotes the corresponding automorphism. It acts on the fields as follows:

$$\begin{aligned} \mathcal{P}(\hat{\phi}_a(x^0, \vec{x})) &= \sum_b \sigma_{ab}^{-1}(\tilde{P}) \hat{\phi}_b(x^0, -\vec{x}), \\ \mathcal{P}(\hat{\psi}_a(x^0, \vec{x})) &= \sum_b \kappa_{ab}^{-1}(\tilde{P}) \hat{\psi}_b(x^0, -\vec{x}). \end{aligned}$$

We have $P^2 = \mathbb{1}$ in the case $+$ and $P^4 = \mathbb{1}$ in the case $-$.

Obviously, P is linear and \mathcal{P} acts on fields linearly.

1.2.16 Time reversal invariance

Chose again $+$ or $-$. Let us replace the group $Spin^\uparrow(1, 3)$ in the Wightman axioms by $Pin_\pm^{\text{chir}}(1, 3)$. We have now representations

$$Pin_\pm^{\text{chir}}(1, 3) \ni \tilde{\Lambda} \mapsto \sigma(\tilde{\Lambda}) \in L(\mathcal{V}), \quad (1.39)$$

$$Pin_\pm^{\text{chir}}(1, 3) \ni \tilde{\Lambda} \mapsto \tau(\tilde{\Lambda}) \in L_{\theta(\tilde{\Lambda})}(\mathcal{W}), \quad (1.40)$$

$$\mathbb{R}^{1,3} \rtimes Spin^\uparrow(1, 3) \ni (y, \tilde{\Lambda}) \mapsto U(y, \tilde{\Lambda}) \in U_{\theta(\tilde{\Lambda})}(\mathcal{H}). \quad (1.41)$$

Note that we demand that (1.40) is θ -linear and (1.41) is θ -unitary. We denote by $[\tau_{ab}(\tilde{\Lambda})]$ the matrix of τ . For nonorthochronous $\tilde{\Lambda}$ we demand that (1.28) is replaced by

$$U(y, \tilde{\Lambda}) \hat{\psi}_a(x) U(y, \tilde{\Lambda})^{-1} = \sum_b \tau_{ab}^{-1}(\tilde{\Lambda}) \hat{\psi}_b^*(\Lambda x + y).$$

The resulting set of axioms will be called the *Wightman axioms of a T -invariant theory*.

In particular, the time reversal is implemented by the anti-unitary operator $T := U(\tilde{T})$. $\mathcal{T} := \mathcal{U}_{\tilde{T}}$ denotes the corresponding automorphism. The time reversal acts on the fields as follows

$$\begin{aligned}\mathcal{T}(\hat{\phi}_a(x^0, \vec{x})) &= \sum_b \sigma_{ab}^{-1}(\tilde{T}) \hat{\phi}_b(-x^0, \vec{x}), \\ \mathcal{T}(\hat{\psi}_a(x^0, \vec{x})) &= \sum_b \tau_{ab}^{-1}(\tilde{T}) \hat{\psi}_b^*(-x^0, \vec{x}).\end{aligned}$$

We have $T^2 = \mathbb{1}$ in the case $+$ and $T^4 = \mathbb{1}$ in the case $-$.

Note that T is antilinear and \mathcal{T} acts on fields antilinearly.

1.2.17 The CPT Theorem

Suppose that we have a theory satisfying the Wightman axioms (without the P and T invariance). As described in Subsubsection 1.1.6 the representations (1.33) and (1.35) possess natural extensions

$$Spin(1, 3) \ni \tilde{\Lambda} \mapsto \sigma(\tilde{\Lambda}) \in L(\mathcal{V}), \quad (1.42)$$

$$Spin(1, 3) \ni \tilde{\Lambda} \mapsto \tau(\tilde{\Lambda}) \in L(\mathcal{W}). \quad (1.43)$$

Let us stress that (1.35) is linear and not θ -linear! A deep theorem, called the *CPT Theorem*, says that we can extend the representation (1.35) to a θ -unitary representation

$$\mathbb{R}^{1,3} \rtimes Spin(1, 3) \ni (y, \tilde{\Lambda}) \mapsto U(y, \tilde{\Lambda}) \in U_{\theta(\tilde{\Lambda})}(\mathcal{H}), \quad (1.44)$$

such that (1.27) and (1.28) hold on the whole $Spin(1, 3)$.

In particular, the spacetime inversion is implemented by the anti-unitary operator $X := U(\tilde{X})$. $\mathcal{X} := \mathcal{U}_{\tilde{X}}$ denotes the corresponding automorphism. Then

$$\begin{aligned}\mathcal{X}(\hat{\phi}_a(x)) &= \sum_b \sigma_{ab}^{-1}(\tilde{X}) \hat{\phi}_b(-x), \\ \mathcal{X}(\hat{\psi}_a(x)) &= \sum_b \tau_{ab}^{-1}(\tilde{X}) \hat{\psi}_b(-x).\end{aligned}$$

Note that X is antilinear but \mathcal{X} acts on the fields linearly.

1.2.18 The CPT Theorem in a P and T -invariant theory

Let $\epsilon, \delta \in \{+, -\}$. Suppose we have a theory that satisfies the Wightman axioms with the P invariance described by the group $Pin_{\epsilon}^{\uparrow}(1, 3)$ and the T invariance described by the group $Pin_{\delta}^{\text{chir}}(1, 3)$. By the CPT Theorem the theory is also

$Spin(1, 3)$ invariant. In particular, we have the matrices $\sigma(\tilde{X})$, $\sigma(\tilde{T})$, $\sigma(\tilde{P})$, $\tau(\tilde{X})$, $\tau(\tilde{T})$ and $\tau(\tilde{P})$. We also have the operators X , T and P . Define

$$\begin{aligned}\alpha &:= \sigma(\tilde{X})\sigma(\tilde{T}^{-1})\sigma(\tilde{P}^{-1}), \\ \kappa &:= \tau(\tilde{X})\overline{\tau(\tilde{T}^{-1})}\tau(\tilde{P}^{-1}), \\ C &:= XT^{-1}P^{-1}.\end{aligned}$$

Then C is unitary and the corresponding automorphism $\mathcal{C}(A) = CAC^{-1}$ satisfies (1.29) and (1.30).

The groups $Pin_{\epsilon}^{\uparrow}(1, 3)$, $Pin_{\delta}^{\text{chir}}(1, 3)$ and $Spin(1, 3)$ can be treated as subgroups of $Pin_{\text{ext}}(1, 3)$. Let G denote the group generated by these three groups together. (Clearly, there are three possibilities: G is $Pin_{\text{ext}}(1, 3)$, $Pin_{-}(1, 3)$ or $Pin_{+}(1, 3)$). Assume that there exists representations

$$\begin{aligned}G \ni \tilde{\Lambda} &\mapsto \sigma(\tilde{\Lambda}) \in L(\mathcal{V}), \\ G \ni \tilde{\Lambda} &\mapsto \tau(\tilde{\Lambda}) \in L_1(\mathcal{W}) \cup L_{-1}(\mathcal{W}),\end{aligned}$$

that extends the representations (1.36) and (1.38) of $Pin_{\epsilon}^{\uparrow}(1, 3)$, (1.39) and (1.40) of $Pin_{\delta}^{\text{chir}}(1, 3)$ and (1.42) and (1.43) of $Spin(1, 3)$. (If such a representation exists, it is clearly unique).

Now $XT^{-1}P^{-1} \in O(1, 3)$ is the identity. Therefore, $\tilde{X}\tilde{T}^{-1}\tilde{P}^{-1} \in G$ is one of the four elements of $Pin_{\text{ext}}(1, 3)$ covering the identity. All of them raised to the fourth power are the identity. Therefore, the matrices α , κ satisfy

$$\alpha^4 = \mathbb{1}, \quad (\kappa\bar{\kappa})^2 = \mathbb{1},$$

which is the condition (1.32). Thus C is an example of a charge conjugation according to the definition of Subsubsection. 1.2.13.

Obviously, $X = CPT$. This explains the name of the CPT Theorem. (Let us stress, however, that the theorem holds also if the theory is not P and T invariant, so that we cannot write $X = CPT$).

1.2.19 N -point Wightman and Green's functions

For simplicity, in this subsection we use Wightman axioms for neutral fields. They allow us to define a multilinear map

$$\begin{aligned}\mathcal{S}(\mathbb{R}^{1,3}, \mathcal{V}) \times \cdots \times \mathcal{S}(\mathbb{R}^{1,3}, \mathcal{V}) \\ \ni (f_N, \dots, f_1) &\mapsto (\Omega|\hat{\phi}[f_N] \cdots \hat{\phi}[f_1]\Omega) \in \mathbb{C},\end{aligned}\quad (1.45)$$

which is separately continuous in its arguments. By the *Schwartz Kernel Theorem* [16, 42], (1.45) can be extended to a linear map

$$\mathcal{S}((\mathbb{R}^{1,3})^N, \mathcal{V}^{\otimes N}) \ni F \mapsto \int W(x_N, \dots, x_1)F(x_N, \dots, x_1)dx_N \cdots dx_1,$$

where $\mathbb{R}^{(1,3)N} \ni (x_N, \dots, x_1) \mapsto W(x_N, \dots, x_1)$ is a tempered distribution on $\mathbb{R}^{(1,3)N}$ with values in the space dual to $\mathcal{V}^{\otimes N}$, called the *N-point Wightman function*, so that (1.45) equals

$$\int W(x_N, \dots, x_1) f_N(x_1) \cdots f_1(x_1) dx_N \dots dx_1.$$

From the point of view of the Wightman axioms, the collection of Wightman functions W_N , $N = 0, 1, \dots$, contains all the information about a given quantum field theory. In particular,

$$\begin{aligned} & \left(\hat{\phi}[f_N] \cdots \hat{\phi}[f_1] \Omega \mid \hat{\phi}[g_M] \cdots \hat{\phi}[g_1] \Omega \right) \\ &= \int W(y_1, \dots, y_N, x_M, \dots, x_1) \\ & \quad \times f_1(x_1) \cdots f_N(x_N) g_M(y_M) \cdots g_1(y_1) dx_1 \cdots dx_N dy_M \cdots dy_1. \end{aligned}$$

This is expressed in the so called *Wightman Reconstruction Theorem* [53].

In practical computations Wightman functions are not often used. Much more frequent are the so-called (*time-ordered*) *Green's functions*. Their formal definition is as follows:

$$\begin{aligned} & \langle \hat{\phi}(x_N) \cdots \hat{\phi}(x_1) \rangle \\ &:= \sum_{\sigma \in S_N} \text{sgn}_\epsilon(\sigma) \theta(x_{\sigma(N)}^0 - x_{\sigma(N-1)}^0) \cdots \theta(x_{\sigma(2)}^0 - x_{\sigma(1)}^0) W(x_{\sigma(N)}, \dots, x_{\sigma(1)}), \end{aligned} \tag{1.46}$$

where $\text{sgn}_a(\sigma)$ is the sign of the permutation of the fermionic elements among $N, \dots, 1$.

Note that we multiply a distribution with a discontinuous function in (1.46), which strictly speaking is illegal. Disregarding this problem, Green's functions are covariant due to the commutativity/anticommutativity of fields at spacelike separations.

1.3 General scattering theory

1.3.1 Time ordered exponential

We will often use the formalism of time-dependent Hamiltonians. In this subsection we describe the main concepts of this formalism.

Assume that I is a unitary involution. (In applications, I will be the fermionic parity operator). We call an operator B *even*, resp. *odd*, if $B = \pm I B I$. Such operators will be called *of pure parity*.

Let $t \mapsto B_k(t), \dots, B_1(t)$ be time dependent operators of pure parity. Let t_n, \dots, t_1 be pairwise distinct. We define the *time-ordered product* of $B_n(t_n), \dots, B_1(t_1)$ by

$$T(B_n(t_n) \cdots B_1(t_1)) := \text{sgn}_a(\sigma) B_{\sigma_n}(t_{\sigma_n}) \cdots B_{\sigma_1}(t_{\sigma_1}),$$

where $(\sigma_1, \dots, \sigma_n)$ is the permutation such that $t_{\sigma_n} \geq \dots \geq t_{\sigma_1}$ and $\text{sgn}_a(\sigma)$ is the sign of this permutation restricted to the odd elements among B_n, \dots, B_1 .

Consider a family of self-adjoint operators

$$t \mapsto H(t). \quad (1.47)$$

We will assume that $H(t)$ are even. (1.47) will be called the *the Schrödinger picture Hamiltonian*. For $t_+ > t_-$, we define the *time-ordered exponential*

$$\begin{aligned} & \text{Texp} \left(-i \int_{t_-}^{t_+} H(t) dt \right) \\ & := \sum_{n=0}^{\infty} (-i)^n \int_{t_+ \geq t_n \geq \dots \geq t_1 \geq t_-} \dots \int H(t_n) \dots H(t_1) dt_n \dots dt_1 \\ & = \sum_{n=0}^{\infty} (-i)^n \int_{t_-}^{t_+} \dots \int_{t_-}^{t_+} \frac{1}{n!} \mathbb{T} (H(t_n) \dots H(t_1)) dt_n \dots dt_1. \end{aligned} \quad (1.48)$$

For brevity, we will write $U(t_+, t_-)$ for (1.48) and call it the *dynamics generated by $t \mapsto H(t)$* . (Of course, if $H(t)$ are unbounded, the above definition should be viewed only as a heuristic indication how to define the family of unitary operators $U(t_+, t_-)$. In general, in most of this subsection we are not very precise about the boundedness of operators, limits, etc.)

We also set $U(t_-, t_+) := U(t_+, t_-)^{-1}$.

Clearly, if $H(t) = H$, then $U(t_+, t_-) = e^{-i(t_+ - t_-)H}$.

1.3.2 Heisenberg picture

Let A be an operator. Its *evolution in the Heisenberg picture* is

$$A(t) := U(0, t)AU(t, 0). \quad (1.49)$$

Equivalently, $A(t)$ is the solution of

$$\frac{d}{dt}A(t) = i[H_{\text{HP}}(t), A(t)], \quad (1.50)$$

$$A(0) = A, \quad (1.51)$$

where the *Hamiltonian in the Heisenberg picture* is defined as

$$t \mapsto H_{\text{HP}}(t) := U(0, t)H(t)U(t, 0). \quad (1.52)$$

Thus a quantum dynamics can be described by two time-dependent Hamiltonians: (1.47) and (1.52). If they do not depend on time, they coincide.

Let us note that a similar distinction exists in classical dynamical systems. Consider a flow on \mathbb{R}^d given by the equation

$$\frac{d}{dt}x(t) = v(t, x(t)).$$

For any initial condition $x(0) = x_0 \in \mathbb{R}^d$, we obtain a solution $\mathbb{R} \ni t \mapsto x(t, x_0)$. Thus any time dependent observable F has two descriptions:

$$\mathbb{R} \times \mathbb{R}^d \ni (t, x) \mapsto F(t, x), \quad (1.53)$$

$$\mathbb{R} \times \mathbb{R}^d \ni (t, x_0) \mapsto F(t, x(t, x_0)). \quad (1.54)$$

In fluid dynamics, (1.53) is sometimes called the *Eulerian* description, and (1.54) the *Lagrangian* description.

In classical mechanics the phase space is described by coordinates $(\phi, \pi) \in \mathbb{R}^m \times \mathbb{R}^m$. The time evolution is described by the Hamilton equations

$$\begin{aligned} \dot{\phi}(t) &= \partial_\pi H(t, \phi(t), \pi(t)), \\ \dot{\pi}(t) &= -\partial_\phi H(t, \phi(t), \pi(t)). \end{aligned}$$

For any initial condition $(\phi_0, \pi_0) \in \mathbb{R}^m \times \mathbb{R}^m$, we obtain a solution of the Hamilton equations. Similarly as in the quantum case, we have two kinds of the classical Hamiltonian:

$$\mathbb{R} \times \mathbb{R}^m \times \mathbb{R}^m \ni (t, \phi, \pi) \mapsto H(t, \phi, \pi), \quad (1.55)$$

$$\mathbb{R} \times \mathbb{R}^m \times \mathbb{R}^m \ni (t, \phi_0, \pi_0) \mapsto H(t, \phi(t, \phi_0, \pi_0), \pi(t, \phi_0, \pi_0)). \quad (1.56)$$

(1.55) is the Hamiltonian in the Eulerian description and (1.56) is the Hamiltonian in the Lagrangian description. The former is the analog of the Schrödinger picture and the latter of the Heisenberg picture. If they do not depend on time, they coincide.

We will use the classical Hamiltonian in the Lagrangian description and the quantum Hamiltonian in the Schrödinger picture as the standard ones.

1.3.3 Time-dependent perturbations

Our time-dependent Hamiltonians will usually have the form

$$H(t) := H_{\text{fr}} + \lambda V(t),$$

where H_{fr} is a self-adjoint operator and $\mathbb{R} \ni t \mapsto V(t)$ is a family of self-adjoint operators. We define the *evolution in the interaction picture* and the *interaction picture Hamiltonian*:

$$\begin{aligned} U_{\text{Int}}(t_+, t_-) &:= e^{it_+ H_{\text{fr}}} U(t_+, t_-) e^{-it_- H_{\text{fr}}}, \\ H_{\text{Int}}(t) &:= \lambda e^{it H_{\text{fr}}} V(t) e^{-it H_{\text{fr}}}. \end{aligned}$$

Note that

$$U_{\text{Int}}(t_+, t_-) = \text{Texp} \left(-i\lambda \int_{t_-}^{t_+} H_{\text{Int}}(t) dt \right).$$

We define the *scattering operator* by

$$\begin{aligned} S &:= \lim_{t_+, -t_- \rightarrow \infty} U_{\text{Int}}(t_+, t_-) \\ &= \text{Texp} \left(-i \int_{-\infty}^{\infty} H_{\text{Int}}(t) dt \right). \end{aligned} \quad (1.57)$$

We also introduce the *Møller operators*

$$\begin{aligned} S^- &:= \lim_{t \rightarrow \infty} U(0, -t) e^{itH_{\text{fr}}} = \lim_{t \rightarrow \infty} U_{\text{Int}}(0, -t) \\ &= \text{Texp} \left(-i \int_{-\infty}^0 H_{\text{Int}}(t) dt \right), \end{aligned} \quad (1.58)$$

$$\begin{aligned} S^+ &:= \lim_{t \rightarrow \infty} U(0, t) e^{-itH_{\text{fr}}} = \lim_{t \rightarrow \infty} U_{\text{Int}}(0, t) \\ &= \text{Texp} \left(-i \int_0^{\infty} H_{\text{Int}}(t) dt \right)^*. \end{aligned} \quad (1.59)$$

Clearly, $S = S^+ S^-$.

For any operator A we distinguish now two Heisenberg pictures – wrt. the *full dynamics* (1.49) and wrt. the *free dynamics*:

$$A_{\text{fr}}(t) := e^{itH_{\text{fr}}} A e^{-itH_{\text{fr}}}. \quad (1.60)$$

Equivalently, $A_{\text{fr}}(t)$ is the solution of

$$\begin{aligned} \frac{d}{dt} A_{\text{fr}}(t) &= i [H_{\text{fr}}, A_{\text{fr}}(t)], \\ A_{\text{fr}}(0) &= A, \end{aligned}$$

1.3.4 Time ordered Green's functions

Assume that H_{fr} and $V(t)$ are even. Let Φ_{fr} be a fixed even vector with $H_{\text{fr}} \Phi_{\text{fr}} = 0$, which we will call the *vacuum*. (In our applications, Φ_{fr} will be always the ground state of H_{fr} .) Let A_k, \dots, A_1 be operators of fixed parity. The *free time-ordered Green's functions* are defined as

$$\begin{aligned} &\langle A_{k,\text{fr}}(t_k) \cdots A_{1,\text{fr}}(t_1) \rangle_{\text{fr}} \\ &:= (\Phi_{\text{fr}} | \text{T}(A_{k,\text{fr}}(t_k) \cdots A_{1,\text{fr}}(t_1)) \Phi_{\text{fr}}), \end{aligned} \quad (1.61)$$

where $A_{i,\text{fr}}(t)$ are A_i in the Heisenberg picture for the free dynamics (1.60).

Suppose that there exist

$$\Phi^\pm := \lim_{t \rightarrow \pm\infty} U(0, t) \Phi_{\text{fr}}. \quad (1.62)$$

The *interacting time-ordered Green's functions* are defined as

$$\begin{aligned} &\langle A_k(t_k) \cdots A_1(t_1) \rangle \\ &:= (\Phi^+ | \text{T}(A_k(t_k) \cdots A_1(t_1)) \Phi^-), \end{aligned} \quad (1.63)$$

where $A_i(t)$ are A_i in the Heisenberg picture for the full dynamics (1.49).

Let $t \mapsto f(t) = (f_1(t), \dots, f_k(t))$ be an n -tuple of functions. If A_i is even, we simply assume that $f_i(t)$ has real values, if A_i is odd, the values of $f_i(t)$ are (anticommuting) Grassmann numbers. The *generating function* is defined as

$$Z(f) = \sum_{N=0}^{\infty} \frac{(-i)^N}{N!} \sum_{i_1} \int f(t_1) dt_1 \cdots \sum_{i_N} \int f(t_N) dt_N \langle A_{i_N}(t_N) \cdots A_{i_1}(t_1) \rangle.$$

Note that the generating function is the vacuum expectation value of a certain scattering operator:

$$Z(f) = (\Phi_{\text{fr}} | S(f) \Phi_{\text{fr}}), \quad (1.64)$$

where $S(f)$ is the scattering operator (1.57) with $\lambda V(t)$ replaced by

$$\lambda V(t) + \sum_i f_i(t) A_i.$$

We can express interacting Green's functions by the free ones:

$$\begin{aligned} \langle A_k(t_k) \cdots A_1(t_1) \rangle &= \sum_{n=0}^{\infty} \frac{(-i\lambda)^n}{n!} \int_{-\infty}^{\infty} ds_n \cdots \int_{-\infty}^{\infty} ds_1 \\ &\times \langle V_{\text{fr}}(s_n, s_n) \cdots V_{\text{fr}}(s_1, s_1) A_{k,\text{fr}}(t_k) \cdots A_{1,\text{fr}}(t_1) \rangle_{\text{fr}}, \end{aligned} \quad (1.65)$$

where $V_{\text{fr}}(s, t) := e^{itH_{\text{fr}}} V(s) e^{-itH_{\text{fr}}}$.

1.3.5 Adiabatic switching and the energy shift

In most of our notes we concentrate on time dependent perturbations that decay sufficiently fast in the past and future. Such perturbations lead to a relatively simple scattering theory, described in Subsubsection 1.3.3 and 1.3.4.

One would like also to consider the case of time-independent perturbations. In fact, let V be a (time-independent) self-adjoint perturbation. In this and the following two subsections we are interested in the time-independent Hamiltonian $H := H_{\text{fr}} + \lambda V$.

It is often convenient to extract information about H from the time-dependent formalism. This can be done by introducing the so called *adiabatical switching* invented by Gell-Mann and Low.

In this subsection we describe how to compute the energy shift using adiabatic switching. We follow quite closely [40].

Let $\epsilon > 0$. We define $V_{\epsilon}(t) := e^{-\epsilon|t|} V$. We will write

$$H_{\epsilon}(t) := H_{\text{fr}} + \lambda V_{\epsilon}$$

for the corresponding time-dependent Hamiltonian. We also introduce the corresponding $H_{\epsilon\text{Int}}, U_{\epsilon}(t_+, t_-), U_{\epsilon\text{Int}}(t_+, t_-), S_{\epsilon}^{\pm}, S_{\epsilon}$.

Proposition 1.9 *We have*

$$\begin{aligned} & i\epsilon\lambda\partial_\lambda U_\epsilon(t_+, t_-) & (1.66) \\ = & \begin{cases} H_\epsilon(t_+)U_\epsilon(t_+, t_-) - U_\epsilon(t_+, t_-)H_\epsilon(t_-), & 0 \geq t_+ \geq t_-; \\ -H_\epsilon(t_+)U_\epsilon(t_+, t_-) + U_\epsilon(t_+, t_-)H_\epsilon(t_-), & t_+ \geq t_- \geq 0; \end{cases} \end{aligned}$$

$$\begin{aligned} & i\epsilon\lambda\partial_\lambda U_{\epsilon\text{Int}}(t_+, t_-) & (1.67) \\ = & \begin{cases} H_{\epsilon\text{Int}}(t_+)U_{\epsilon\text{Int}}(t_+, t_-) - U_{\epsilon\text{Int}}(t_+, t_-)H_{\epsilon\text{Int}}(t_-), & 0 \geq t_+ \geq t_-; \\ -H_{\epsilon\text{Int}}(t_+)U_{\epsilon\text{Int}}(t_+, t_-) + U_{\epsilon\text{Int}}(t_+, t_-)H_{\epsilon\text{Int}}(t_-), & t_+ \geq t_- \geq 0; \end{cases} \end{aligned}$$

$$\pm i\epsilon\lambda\partial_\lambda S_\epsilon^\pm = HS_\epsilon^\pm - S_\epsilon^\pm H_{\text{fr}}; \quad (1.68)$$

$$i\epsilon\lambda\partial_\lambda S_\epsilon = H_{\text{fr}}S_\epsilon + S_\epsilon H_{\text{fr}} - 2S_\epsilon^{+*}HS_\epsilon^-. \quad (1.69)$$

Proof. Display the dependence on λ by writing $U_{\epsilon,\lambda}(t_+, t_-)$. For $t_+ \geq t_- \geq 0$ we have

$$U_{\epsilon,\lambda}(t_+, t_-) = U_{\epsilon,\lambda e^{\theta\epsilon}}(t_+ + \theta, t_- + \theta).$$

Hence,

$$\begin{aligned} 0 &= \left. \frac{d}{d\theta} U_{\epsilon,\lambda e^{\theta\epsilon}}(t_+ + \theta, t_- + \theta) \right|_{\theta=0} \\ &= \epsilon\lambda\partial_\lambda U_{\epsilon,\lambda}(t_+, t_-) + \frac{d}{dt_+} U_{\epsilon,\lambda}(t_+, t_-) + \frac{d}{dt_-} U_{\epsilon,\lambda}(t_+, t_-) \\ &= \epsilon\lambda\partial_\lambda U_{\epsilon,\lambda}(t_+, t_-) - iH_{\epsilon,\lambda}(t_+)U_{\epsilon,\lambda}(t_+, t_-) + iU_{\epsilon,\lambda}(t_+, t_-)H_{\epsilon,\lambda}(t_-). \end{aligned}$$

This proves (1.66), from which the remaining identities follow. \square

Assume that Φ_{fr} is an eigenvector of H_{fr} with $H_{\text{fr}}\Phi_{\text{fr}} = E_{\text{fr}}\Phi_{\text{fr}}$. Set

$$\begin{aligned} \Phi_\epsilon^\pm &:= \frac{S_\epsilon^\pm \Phi_{\text{fr}}}{(\Phi_{\text{fr}} | S_\epsilon^\pm \Phi_{\text{fr}})}, \\ E_\epsilon^\pm &:= \frac{(\Phi_{\text{fr}} | HS_\epsilon^\pm \Phi_{\text{fr}})}{(\Phi_{\text{fr}} | S_\epsilon^\pm \Phi_{\text{fr}})} = (\Phi_{\text{fr}} | H \Phi_\epsilon^\pm). \end{aligned}$$

Proposition 1.10

$$(H - E_{\text{fr}} \pm i\epsilon\lambda\partial_\lambda)S_\epsilon^\pm \Phi_{\text{fr}} = 0, \quad (1.70)$$

$$\mp i\epsilon\lambda\partial_\lambda \log(\Phi_{\text{fr}} | S_\epsilon^\pm \Phi_{\text{fr}}) = E_\epsilon^\pm - E_{\text{fr}}, \quad (1.71)$$

$$(H - E_\epsilon^\pm \pm i\epsilon\lambda\partial_\lambda) \Phi_\epsilon^\pm = 0. \quad (1.72)$$

Proof. Applying (1.68) to Φ_{fr} yields (1.70). We scalar multiply it with Φ_{fr} obtaining (1.71). Combining (1.70) with (1.71) gives (1.72). \square

In the following theorem we argue that the adiabatic switching often allows us to compute an eigenvector of H and its eigenvalue.

Theorem 1.11 (1) *Assume that*

$$\text{there exist a nonzero } \lim_{\epsilon \searrow 0} \Phi_\epsilon^\pm. \quad (1.73)$$

Then there exist

$$\begin{aligned} E_{\text{GL}}^\pm &:= \lim_{\epsilon \searrow 0} E_\epsilon^\pm, \\ \Phi_{\text{GL}}^\pm &:= \lim_{\epsilon \searrow 0} |(\Phi_{\text{fr}} | S_\epsilon^\pm \Phi_{\text{fr}})| \Phi_\epsilon^\pm. \end{aligned}$$

(2) *Suppose in addition that*

$$\lim_{\epsilon \searrow 0} \epsilon \lambda \partial_\lambda \Phi_\epsilon^\pm = 0. \quad (1.74)$$

Then

$$H \Phi_{\text{GL}}^\pm = E_{\text{GL}}^\pm \Phi_{\text{GL}}^\pm.$$

Proof. (1) The existence of E_{GL}^\pm is immediate. Next we note that $(\Phi_\epsilon^\pm | \Phi_\epsilon^\pm) = |(\Phi_{\text{fr}} | S_\epsilon^\pm \Phi_{\text{fr}})|^{-2}$. Hence $\lim_{\epsilon \searrow 0} |(\Phi_{\text{fr}} | S_\epsilon^\pm \Phi_{\text{fr}})|$ exists. This implies the existence of Φ_{GL}^\pm .

By (1.72), we have

$$(H - E_{\text{GL}}^\pm) \lim_{\epsilon \searrow 0} \Phi_\epsilon^\pm = 0.$$

This implies (2). \square

In the remaining part of this subsection we assume that (1.73) and (1.74) are true.

Suppose now that for small enough $\lambda_0 > 0$ and $|\lambda| < \lambda_0$, H_λ has a unique nondegenerate eigenvalue close to E_{fr} , which we denote E_λ , depending continuously on λ , with $E_0 = E_{\text{fr}}$. If $E_{\text{GL},\lambda}^\pm$ also depends continuously on λ , then we see that $E_{\text{GL},\lambda}^+ = E_{\text{GL},\lambda}^- = E_\lambda$ and $\Phi_{\text{GL},\lambda}^+$ is proportional to $\Phi_{\text{GL},\lambda}^-$. Note that both $\Phi_{\text{GL},\lambda}^+$ and $\Phi_{\text{GL},\lambda}^-$ are normalized, hence they may differ only by a phase factor.

In what follows we simply assume that

$$E := E_{\text{GL}}^+ = E_{\text{GL}}^-, \quad \Phi := \Phi_{\text{GL}}^+ = e^{i\alpha} \Phi_{\text{GL}}^-. \quad (1.75)$$

is true (even if the argument given above does not apply).

Lemma 1.12 *Let B be an operator. Then*

$$(\Phi | B \Phi) = \lim_{\epsilon \searrow 0} \frac{(S_\epsilon^+ \Phi_{\text{fr}} | B S_\epsilon^- \Phi_{\text{fr}})}{(\Phi_{\text{fr}} | S_\epsilon \Phi_{\text{fr}})}. \quad (1.76)$$

Proof. The right hand side of (1.76) equals

$$\lim_{\epsilon \searrow 0} \frac{(S_\epsilon^+ \Phi_{\text{fr}} | B S_\epsilon^- \Phi_{\text{fr}})}{(S_\epsilon^+ \Phi_{\text{fr}} | S_\epsilon^- \Phi_{\text{fr}})} = \lim_{\epsilon \searrow 0} \frac{(\Phi_\epsilon^+ | B \Phi_\epsilon^-)}{(\Phi_\epsilon^+ | \Phi_\epsilon^-)} = \frac{(\Phi_{\text{GL}}^+ | B \Phi_{\text{GL}}^-)}{(\Phi_{\text{GL}}^+ | \Phi_{\text{GL}}^-)}.$$

□

The following theorem describes the *Sucher formula* often used in practical computations of the energy shift.

Theorem 1.13

$$E - E_{\text{fr}} = \lim_{\epsilon \searrow 0} \frac{i\epsilon\lambda}{2} \partial_\lambda \log(\Phi_{\text{fr}} | S_\epsilon \Phi_{\text{fr}}). \quad (1.77)$$

Proof. We sandwich (1.69) with Φ_{fr} and divide with $(\Phi_{\text{fr}} | S_\epsilon \Phi_{\text{fr}})$ obtaining

$$-i\epsilon\lambda \partial_\lambda \log(\Phi_{\text{fr}} | S_\epsilon \Phi_{\text{fr}}) = 2E_{\text{fr}} - 2 \frac{(S_\epsilon^+ \Phi_{\text{fr}} | H S_\epsilon^- \Phi_{\text{fr}})}{(S_\epsilon^+ \Phi_{\text{fr}} | S_\epsilon^- \Phi_{\text{fr}})}.$$

The last term, by Lemma 1.12, converges to $2E$. □

Note that the right hand side of the Sucher formula may have a nonzero imaginary part. In this case we expect that it describes a resonance close to E_{fr} .

1.3.6 Adiabatic switching and Green's functions

Recall that if A is an operator then $A(t) = e^{itH} A e^{-itH}$. To define the interacting Green's functions we fix a vector Φ , which is a bound state of H , and we set

$$\langle A_k(t_k) \cdots A_1(t_1) \rangle := (\Phi | T(A_k(t_k) \cdots A_1(t_1)) \Phi).$$

Suppose that $H = H_{\text{fr}} + \lambda V$. The *Gell-Mann and Low Theorem about Green's functions* allows us to express interacting Green's functions by the free ones:

Theorem 1.14 *Suppose that (1.73), (1.74) and (1.75) are true, so that we can apply the results of the previous subsection. Then*

$$\langle A_k(t_k) \cdots A_1(t_1) \rangle = \lim_{\epsilon \searrow 0} \frac{1}{(\Phi_{\text{fr}} | S_\epsilon \Phi_{\text{fr}})} \sum_{n=0}^{\infty} \frac{(-i\lambda)^n}{n!} \quad (1.78)$$

$$\times \int_{-\infty}^{\infty} ds_n \cdots \int_{-\infty}^{\infty} ds_1 \langle V_\epsilon(s_n) \cdots V_\epsilon(s_1) A_k(t_k) \cdots A_1(t_1) \rangle_{\text{fr}},$$

$$\begin{aligned} (\Phi_{\text{fr}} | S_\epsilon \Phi_{\text{fr}}) &= \lim_{\epsilon \searrow 0} \sum_{n=0}^{\infty} \frac{(-i\lambda)^n}{n!} \int_{-\infty}^{\infty} ds_n \cdots \int_{-\infty}^{\infty} ds_1 \\ &\quad \times \langle V_\epsilon(s_n) \cdots V_\epsilon(s_1) \rangle_{\text{fr}}. \end{aligned} \quad (1.79)$$

Proof. (1.79) follows from (1.57) applied to U_ϵ .

Let us prove (1.78). Let $t_k \geq \cdots \geq t_1$. Let $A_{i,\epsilon}(t)$ denote the operator A_i in the Heisenberg picture for the evolution U_ϵ . The left-hand side of (1.78) is

$$\begin{aligned} &(\Phi | A_k(t_k) \cdots A_1(t_1) \Phi) \\ &= \lim_{\epsilon \searrow 0} (\Phi | A_{k,\epsilon}(t_k) \cdots A_{1,\epsilon}(t_1) \Phi) \\ &= \lim_{\epsilon \searrow 0} \frac{(S_\epsilon^+ \Phi_{\text{fr}} | A_{k,\epsilon}(t_k) \cdots A_{1,\epsilon}(t_1) S_\epsilon^- \Phi_{\text{fr}})}{(\Phi_{\text{fr}} | S_\epsilon \Phi_{\text{fr}})}, \end{aligned} \quad (1.80)$$

where at the last step we used Lemma 1.12.

Let $\langle \cdots \rangle_\epsilon$ denote Green's functions for the dynamics U_ϵ . Then the numerator of (1.80) can be written as

$$\langle A_{k,\epsilon}(t_k) \cdots A_{1,\epsilon}(t_1) \rangle_\epsilon. \quad (1.81)$$

Applying (1.65) to (1.81) we arrive at (1.78). \square

Let us note that on the right of (1.78) only the free dynamics appears. One can forget about the dynamics U_ϵ , whose use can be treated as a trick. Some authors consider (1.78) as a (perturbative) definition of Green's functions, forgetting about the auxiliary nonphysical dynamics U_ϵ .

1.3.7 Adiabatic scattering theory

In our notes we concentrate on time-dependent Hamiltonians, with perturbations decaying fast as $|t| \rightarrow \infty$. For such Hamiltonians the definitions of Møller and scattering operators given in (1.57), (1.58) and (1.59) work well.

One would also like to consider scattering theory of time-independent Hamiltonians. Unfortunately, in QFT these definitions typically need to be modified.

In Quantum Mechanics the situation is much better. For (time-independent) Schrödinger Hamiltonians $H := H_{\text{fr}} + V(x)$, $H_{\text{fr}} := -\Delta$, (at least with short-range potentials) there exists a very satisfactory scattering theory based on the Møller operators

$$S^\pm := s\text{-}\lim_{t \rightarrow \pm\infty} e^{itH} e^{-itH_{\text{fr}}} \quad (1.82)$$

and the scattering operator by $S := S^{+*} S^-$.

This approach almost never works in QFT, even for simple-minded models with classical (time-independent) perturbations considered in these notes. In particular, the limit (1.82) almost never exists. One of the reasons is the existence of the ground state for H_{fr} in quantum field theory. H has essentially always a different ground state or no ground state at all. It usually has a different spectrum.

One can try to remedy this problem by introducing adiabatic switching together with a renormalization of the phase, which is divergent as $\epsilon \searrow 0$, as in the following theorem:

Theorem 1.15 *Suppose that (1.73), (1.74) and (1.75) are true.*

- (1) *Assume also that there exist the adiabatic or Gell-Mann–Low Møller operators*

$$S_{\text{GL}}^\pm := w\text{-}\lim_{\epsilon \searrow 0} \frac{|(\Phi_{\text{fr}} | S_\epsilon^\pm \Phi_{\text{fr}})|}{(\Phi_{\text{fr}} | S_\epsilon^\pm \Phi_{\text{fr}})} S_\epsilon^\pm, \quad (1.83)$$

and

$$w\text{-}\lim_{\epsilon \searrow 0} \epsilon \lambda \partial_\lambda \frac{|(\Phi_{\text{fr}} | S_\epsilon^\pm \Phi_{\text{fr}})|}{(\Phi_{\text{fr}} | S_\epsilon^\pm \Phi_{\text{fr}})} S_\epsilon^\pm = 0. \quad (1.84)$$

Then

$$S_{\text{GL}}^{\pm}(H_{\text{fr}} - E_{\text{fr}}) = (H - \text{Re}E)S_{\text{GL}}^{\pm}, \quad (1.85)$$

$$S_{\text{GL}}^{\pm}\Phi_{\text{fr}} = \Phi_{\text{GL}}^{\pm}. \quad (1.86)$$

(2) Define the adiabatic or Gell-Mann–Low scattering operator

$$S_{\text{GL}} = S_{\text{GL}}^{+*}S_{\text{GL}}^{-}. \quad (1.87)$$

Then

$$\begin{aligned} S_{\text{GL}}H_{\text{fr}} &= H_{\text{fr}}S_{\text{GL}}, \\ S_{\text{GL}}\Phi_{\text{fr}} &= e^{i\alpha}\Phi_{\text{fr}}. \end{aligned}$$

Proof. Using $\frac{|f|}{f} = \sqrt{\frac{f}{f}}$, we obtain $i\partial_{\lambda}\frac{|f|}{f} = -\frac{|f|}{f}\text{Re}\frac{i\partial_{\lambda}f}{f}$. Therefore, setting $f := (\Phi_{\text{fr}}|S_{\epsilon}^{\pm}\Phi_{\text{fr}})$ we compute

$$\begin{aligned} \mp i\epsilon\lambda\partial_{\lambda}\frac{|\langle\Phi_{\text{fr}}|S_{\epsilon}^{\pm}\Phi_{\text{fr}}\rangle|}{\langle\Phi_{\text{fr}}|S_{\epsilon}^{\pm}\Phi_{\text{fr}}\rangle} &= -\frac{|\langle\Phi_{\text{fr}}|S_{\epsilon}^{\pm}\Phi_{\text{fr}}\rangle|}{\langle\Phi_{\text{fr}}|S_{\epsilon}^{\pm}\Phi_{\text{fr}}\rangle}\text{Re}\frac{\langle\Phi_{\text{fr}}|(HS_{\epsilon}^{\pm} - S_{\epsilon}^{\pm}H_{\text{fr}})\Phi_{\text{fr}}\rangle}{\langle\Phi_{\text{fr}}|S_{\epsilon}^{\pm}\Phi_{\text{fr}}\rangle} \\ &= -\frac{|\langle\Phi_{\text{fr}}|S_{\epsilon}^{\pm}\Phi_{\text{fr}}\rangle|}{\langle\Phi_{\text{fr}}|S_{\epsilon}^{\pm}\Phi_{\text{fr}}\rangle}\text{Re}(E_{\epsilon}^{\pm} - E_{\text{fr}}). \end{aligned}$$

Therefore,

$$\begin{aligned} &\mp i\epsilon\lambda\partial_{\lambda}\frac{|\langle\Phi_{\text{fr}}|S_{\epsilon}^{\pm}\Phi_{\text{fr}}\rangle|}{\langle\Phi_{\text{fr}}|S_{\epsilon}^{\pm}\Phi_{\text{fr}}\rangle}S_{\epsilon}^{\pm} \\ &= -\frac{|\langle\Phi_{\text{fr}}|S_{\epsilon}^{\pm}\Phi_{\text{fr}}\rangle|}{\langle\Phi_{\text{fr}}|S_{\epsilon}^{\pm}\Phi_{\text{fr}}\rangle}(-HS_{\epsilon}^{\pm} + S_{\epsilon}^{\pm}H_{\text{fr}} + \text{Re}(E_{\epsilon}^{\pm} - E_{\text{fr}})S_{\epsilon}^{\pm}). \end{aligned}$$

Using $\text{Re}E_{\text{fr}} = E_{\text{fr}}$, we obtain (1.85). (1.86) follows by definition. \square

If the limit in (1.84) is strong and not only weak, S_{GL}^{\pm} are unitary. This will be the case in the examples we consider in our text. In general, they do not have to be unitary, and one needs to perform an additional *wave function renormalization*, which we will not discuss.

Remark 1.16 *Many textbooks use (1.82) as the starting point for a derivation of the rules of QFT, eg. [56]. As indicated above, this is quite far from being correct. Gell-Mann and Low invented the adiabatic switching as an attempt to make this derivation somewhat more satisfactory. This approach often works in QFT models with classical perturbations.*

2 Neutral scalar bosons

In this section we consider the *Klein-Gordon equation*

$$(-\square + m^2)\phi(x) = 0 \quad (2.1)$$

and we quantize the space of its *real solutions*. We study two kinds of interactions: an *external linear source*

$$(-\square + m^2)\phi(x) = -j(x), \quad (2.2)$$

and a *mass-like perturbation*

$$(-\square + m^2)\phi(x) = -\kappa(x)\phi(x). \quad (2.3)$$

2.1 Free neutral scalar bosons

2.1.1 Special solutions and Green's functions

Every function ζ that solves the (homogeneous) Klein-Gordon equation

$$(-\square + m^2)\zeta(x) = 0 \quad (2.4)$$

can be written as

$$\begin{aligned} \zeta(x) &= \int e^{ikx} g(k) \delta(k^2 + m^2) \frac{dk}{(2\pi)^3} \\ &= \sum_{\pm} \int \frac{d\vec{k}}{(2\pi)^3 2\sqrt{\vec{k}^2 + m^2}} g\left(\pm \sqrt{\vec{k}^2 + m^2}, \vec{k}\right) e^{\mp ix^0 \sqrt{\vec{k}^2 + m^2} + i\vec{x}\vec{k}}, \end{aligned}$$

where g is a function on the two-sheeted hyperboloid $k^2 + m^2 = 0$. A special role is played by the following 3 *special solutions* of the homogeneous Klein-Gordon equation.

- (1) The *positive frequency* or *Wightman*, resp. *negative frequency* or *anti-Wightman solution*:

$$\begin{aligned} D^{(\pm)}(x) &= \pm i \int e^{ikx} \theta(\pm k^0) \delta(k^2 + m^2) \frac{dk}{(2\pi)^3} \\ &= \pm i \int \frac{d\vec{k}}{(2\pi)^3 2\sqrt{\vec{k}^2 + m^2}} e^{\mp ix^0 \sqrt{\vec{k}^2 + m^2} + i\vec{x}\vec{k}} \\ &= \frac{1}{4\pi} \text{sgn} x^0 \delta(x^2) \\ &\quad \pm \frac{m\theta(-x^2)}{8\pi\sqrt{-x^2}} H_1^{\mp \text{sgn} x^0}(m\sqrt{-x^2}) \pm \frac{m i \theta(x^2)}{4\pi^2 \sqrt{x^2}} K_1(m\sqrt{x^2}). \end{aligned}$$

where H_1^{\pm} are the Hankel functions and K_1 is the MacDonald function of the 1st order.

- (2) The *Pauli-Jordan* or the *commutator function*:

$$\begin{aligned} D(x) &= i \int e^{ikx} \text{sgn}(k^0) \delta(k^2 + m^2) \frac{dk}{(2\pi)^3} \\ &= \int \frac{d\vec{k}}{(2\pi)^3 \sqrt{\vec{k}^2 + m^2}} e^{i\vec{x}\vec{k}} \sin\left(x^0 \sqrt{\vec{k}^2 + m^2}\right) \\ &= \frac{1}{2\pi} \text{sgn} x^0 \delta(x^2) - \frac{m \text{sgn} x^0 \theta(-x^2)}{4\pi\sqrt{-x^2}} J_1(m\sqrt{-x^2}), \end{aligned}$$

where J_1 is the Bessel function of the 1st order. $D(x)$ is the unique solution of the Klein-Gordon equation satisfying

$$D(0, \vec{x}) = 0, \quad \dot{D}(0, \vec{x}) = \delta(\vec{x}).$$

We have, $\text{supp}D \subset J$.

Solutions of

$$(-\square + m^2)\zeta(x) = \delta(x), \quad (2.5)$$

are called *Green's functions* or *fundamental solutions* of the Klein-Gordon equation. In particular, let us introduce the following 3 Green's functions.

(1) The *retarded*, resp. *advanced Green's function*:

$$\begin{aligned} D^\pm(x) &= \int \frac{e^{ikx}}{(k^2 + m^2 \mp i0\text{sgn}k^0)} \frac{dk}{(2\pi)^4} \\ &= \frac{1}{2\pi} \theta(\pm x^0) \delta(x^2) - \frac{m\theta(-x^2)\theta(\pm x^0)}{4\pi\sqrt{-x^2}} J_1(m\sqrt{-x^2}). \end{aligned}$$

We have $\text{supp}D^\pm \subset J^\pm$. In the literature, $D^+(x)$ is usually denoted $D^{\text{ret}}(x)$ and $D^-(x)$ is usually denoted $D^{\text{adv}}(x)$.

(2) The *causal* or *Feynman(-Stueckelberg) Green's function*:

$$\begin{aligned} D^c(x) &= \int \frac{e^{ikx}}{(k^2 + m^2 - i0)} \frac{dk}{(2\pi)^4} \\ &= \frac{1}{4\pi} \delta(x^2) - \frac{m\theta(-x^2)}{8\pi\sqrt{-x^2}} H_1^-(m\sqrt{-x^2}) + \frac{mi\theta(x^2)}{4\pi^2\sqrt{x^2}} K_1(m\sqrt{x^2}). \end{aligned}$$

The special solutions and Green's functions introduced above are often called *propagators*. They satisfy the following relations

$$\begin{aligned} \overline{D(x)} = D(x) = -D(-x) &= D^{(+)}(x) + D^{(-)}(x) \\ &= D^+(x) - D^-(x), \\ \overline{D^{(-)}(x)} = D^{(+)}(x) &= -D^{(-)}(-x), \\ \overline{D^+(x)} = D^+(x) = D^-(-x) &= \theta(x^0)D(x), \\ \overline{D^-(x)} = D^-(x) = D^+(-x) &= \theta(-x^0)D(x), \\ D^c(x) = D^c(-x) &= \theta(x^0)D^{(+)}(x) - \theta(-x^0)D^{(-)}(x). \end{aligned}$$

Let us prove the last identity.

$$\begin{aligned} D^c(x) &= \int \frac{e^{ikx}}{(\vec{k}^2 + m^2 - (|k^0| + i0)^2)} \frac{dk}{(2\pi)^4} \\ &= \frac{1}{(2\pi)^4} \int \frac{e^{-ik^0 x^0 + i\vec{k}\vec{x}}}{2\sqrt{\vec{k}^2 + m^2} (\sqrt{\vec{k}^2 + m^2} - |k^0| - i0)} dk \quad (2.6) \end{aligned}$$

$$+ \int \frac{e^{-ik^0 x^0 + i\vec{k}\vec{x}}}{2\sqrt{\vec{k}^2 + m^2} (\sqrt{\vec{k}^2 + m^2} + |k^0| + i0)} \frac{dk}{(2\pi)^4}. \quad (2.7)$$

In (2.7) we can replace $i0$ with $-i0$. Then the parts of (2.6) and (2.7) with $k^0 < 0$ are swapped:

$$\begin{aligned}
&= \int \frac{e^{-ik^0x^0+i\vec{k}\vec{x}}}{2\sqrt{\vec{k}^2+m^2}(\sqrt{\vec{k}^2+m^2}-k^0-i0)} \frac{d\vec{k}}{(2\pi)^4} \\
&\quad + \int \frac{e^{-ik^0x^0+i\vec{k}\vec{x}}}{2\sqrt{\vec{k}^2+m^2}(\sqrt{\vec{k}^2+m^2}+k^0-i0)} \frac{d\vec{k}}{(2\pi)^4}, \\
&= i\theta(x^0) \int \frac{e^{-i\sqrt{\vec{k}^2+m^2}x^0+i\vec{k}\vec{x}}}{2\sqrt{\vec{k}^2+m^2}} \frac{d\vec{k}}{(2\pi)^3} \\
&\quad + i\theta(-x^0) \int \frac{e^{i\sqrt{\vec{k}^2+m^2}x^0+i\vec{k}\vec{x}}}{2\sqrt{\vec{k}^2+m^2}} \frac{d\vec{k}}{(2\pi)^3} \\
&= \theta(x^0)D^{(+)}(x) - \theta(-x^0)D^{(-)}(x).
\end{aligned}$$

where in the last step we integrate wrt k^0 using

$$\int \frac{e^{-ix^0k^0}}{\varepsilon \mp k^0 - i0} dk^0 = 2\pi i e^{\mp ix^0\varepsilon} \theta(\pm x^0).$$

Let us now prove that $\text{supp}D^+ \subset J^+$. By the Lorentz invariance it suffices to prove that D^+ is zero on the lower half-plane. We write

$$\begin{aligned}
D^+(x) &= \int \frac{e^{ikx}}{(k^2+m^2-i0\text{sgn}k^0)} \frac{dk}{(2\pi)^4} \\
&= \int \frac{e^{-ik^0x^0+i\vec{k}\vec{x}}}{(\vec{k}^2+m^2-(k^0+i0)^2)} \frac{dk^0 d\vec{k}}{(2\pi)^4}.
\end{aligned}$$

Next we continuously deform the contour of integration, replacing k^0 by k^0+iR , where $R \in [0, \infty[$. We do not cross any singularities of the integrand and note that $e^{-ix^0(k^0+iR)}$ goes to zero (remember that $x^0 < 0$).

2.1.2 Space of solutions

A space-like subspace of codimension 1 will be called a *Cauchy subspace*.

Solutions of the *Cauchy problem* are uniquely parametrized by their *Cauchy data* (the value and the normal derivative on a Cauchy surface). They can be expressed by the Cauchy data with help of the Pauli-Jordan function.

Theorem 2.1 *Let $\varsigma, \vartheta \in C_c^\infty(\mathbb{R}^3)$. Then there exists a unique $\zeta \in C_{\text{sc}}^\infty(\mathbb{R}^{1,3})$ that solves*

$$(-\square + m^2)\zeta = 0 \tag{2.8}$$

with initial conditions $\zeta(0, \vec{x}) = \varsigma(\vec{x})$, $\dot{\zeta}(0, \vec{x}) = \vartheta(\vec{x})$. It satisfies $\text{supp}\zeta \subset J(\text{supp}\varsigma \cup \text{supp}\vartheta)$ and is given by

$$\zeta(t, \vec{x}) = \int_{\mathbb{R}^3} \dot{D}(t, \vec{x} - \vec{y})\varsigma(\vec{y})d\vec{y} + \int_{\mathbb{R}^3} D(t, \vec{x} - \vec{y})\vartheta(\vec{y})d\vec{y}. \tag{2.9}$$

Let \mathcal{Y}_{KG} , resp. $\mathbb{C}\mathcal{Y}_{\text{KG}}$ denote the *space of real*, resp. *complex, space-compact solutions of the Klein-Gordon equation*.

For $\zeta_1, \zeta_2 \in C^\infty(\mathbb{R}^{1,3})$ we define

$$j^\mu(x) = j^\mu(\zeta_1, \zeta_2, x) := \partial^\mu \zeta_1(x) \zeta_2(x) - \zeta_1(x) \partial^\mu \zeta_2(x). \quad (2.10)$$

We easily check that

$$\partial_\mu j^\mu(x) = (\square - m^2) \zeta_1(x) \zeta_2(x) - \zeta_1(x) (\square - m^2) \zeta_2(x),$$

Therefore, if $\zeta_1, \zeta_2 \in \mathbb{C}\mathcal{Y}_{\text{KG}}$, then

$$\partial_\mu j^\mu(x) = 0.$$

One says that $j^\mu(x)$ is a *conserved 4-current*.

The flux of j^μ across any Cauchy subspace \mathcal{S} does not depend on its choice. It defines a *symplectic form* on \mathcal{Y}_{KG}

$$\begin{aligned} \zeta_1 \omega \zeta_2 &= \int_{\mathcal{S}} j^\mu(\zeta_1, \zeta_2, x) ds_\mu(x) \\ &= \int \left(-\dot{\zeta}_1(t, \vec{x}) \zeta_2(t, \vec{x}) + \zeta_1(t, \vec{x}) \dot{\zeta}_2(t, \vec{x}) \right) d\vec{x}. \end{aligned} \quad (2.11)$$

Clearly, the form (2.11) is well defined also if only $\zeta_2 \in \mathcal{Y}_{\text{KG}}$, and ζ_1 is a distributional solution of the Klein-Gordon equation.

The Poincaré group $\mathbb{R}^{1,3} \rtimes O(1,3)$ acts on \mathcal{Y}_{KG} and $\mathbb{C}\mathcal{Y}_{\text{KG}}$ by

$$r_{(y,\Lambda)} \zeta(x) := \zeta((y, \Lambda)^{-1} x).$$

$r_{(y,\Lambda)}$ are symplectic (preserve the symplectic form) for $\Lambda \in O^\uparrow(1,3)$, otherwise they are antisymplectic (change the sign in front of the symplectic form).

The Pauli-Jordan function D can be used to construct solutions of the Klein-Gordon equation parametrized by space-time functions, which are especially useful in the axiomatic formulation of QFT.

Theorem 2.2 (1) For any $f \in C_c^\infty(\mathbb{R}^{1,3}, \mathbb{R})$, $D * f \in \mathcal{Y}_{\text{KG}}$, where

$$D * f(x) := \int D(x-y) f(y) dy.$$

(2) Every element of \mathcal{Y}_{KG} is of this form.

(3)

$$-(D * f_1) \omega(D * f_2) = \int f_1(x) D(x-y) f_2(y) dx dy. \quad (2.12)$$

(4) If $\text{supp} f_1 \times \text{supp} f_2$, then

$$(D * f_1) \omega(D * f_2) = 0.$$

The right hand side of (2.12) is sometimes called the *Peierls bracket* of f_1 and f_2 .

Let us prove (2.12). Choose time t later than $\text{supp} f_i$, $i = 1, 2$. Then we have $D * f_i = D^+ * f_i$. Now

$$\begin{aligned}
& -(D * f_1)\omega(D * f_2) \\
&= \int \left((\dot{D}^+ * f_1)(t, \vec{x})(D^+ * f_2)(t, \vec{x}) - (D^+ * f_1)(t, \vec{x})(\dot{D}^+ * f_2)(t, \vec{x}) \right) d\vec{x} \\
&= \int_{x^0 < t} \left(-(\square - m^2)(D^+ * f_1)(x)(D^+ * f_2)(x) \right. \\
&\quad \left. + (D^+ * f_1)(x)(\square - m^2)(D^+ * f_2)(x) \right) dx \\
&= \int (f_1(x)(D^+ * f_2)(x) - (D^+ * f_1)(x)f_2(x)) dx \\
&= \int (f_1(x)(D^+ * f_2)(x) - f_1(x)(D^- * f_2)(x)) dx = \int f_1(x)(D * f_2)(x) dx.
\end{aligned}$$

2.1.3 Classical fields

We will also consider the *space dual to \mathcal{Y}_{KG}* . More precisely, we can endow the space \mathcal{Y}_{KG} with the standard topology of $C_c^\infty(\mathbb{R}^3) \oplus C_c^\infty(\mathbb{R}^3)$ given by the initial conditions. The space of real, resp. complex continuous functionals on \mathcal{Y}_{KG} will be denoted by $\mathcal{Y}_{\text{KG}}^\#$, resp. by $\mathbb{C}\mathcal{Y}_{\text{KG}}^\#$. The action of $T \in \mathbb{C}\mathcal{Y}_{\text{KG}}^\#$ on $\zeta \in \mathcal{Y}_{\text{KG}}$ will be denoted by $\langle T | \zeta \rangle$, and sometimes simply by $T\zeta$.

If $T \in \mathbb{C}\mathcal{Y}_{\text{KG}}^\#$, we define $T^* \in \mathbb{C}\mathcal{Y}_{\text{KG}}^\#$ by

$$\langle T^* | \zeta \rangle := \overline{\langle T | \zeta \rangle}, \quad \zeta \in \mathcal{Y}_{\text{KG}}.$$

Note that in this context the star does not denote the Hermitian conjugation (which in our text is the standard meaning of the star).

Let us stress that the space \mathcal{Y}_{KG} is real, which reflects the fact that in this section we consider neutral fields. In the section devoted to charged fields the main role will be played by the complexification of \mathcal{Y}_{KG} , that is $\mathcal{W}_{\text{KG}} := \mathbb{C}\mathcal{Y}_{\text{KG}}$.

For $x \in \mathbb{R}^{1,3}$, $\phi(x)$, $\pi(x)$ will denote the functionals on \mathcal{Y}_{KG} given by

$$\langle \phi(x) | \zeta \rangle := \zeta(x), \quad \langle \pi(x) | \zeta \rangle := \dot{\zeta}(x).$$

They are called *classical fields*. Clearly, for any $\zeta \in \mathcal{Y}_{\text{KG}}$ we have

$$(-\square + m^2)\langle \phi(x) | \zeta \rangle = 0.$$

Thus the equation

$$(-\square + m^2)\phi(x) = 0 \tag{2.13}$$

is a tautology.

On $\mathcal{Y}_{\text{KG}}^\#$ we have the action of the Poincaré group $(y, \Lambda) \mapsto r_{(y, \Lambda)}^{\#-1}$. Note that

$$r_{(y, \Lambda)}^{\#-1}\phi(x) = \phi(\Lambda x + y).$$

Clearly, $\dot{\phi}(x) = \pi(x)$ and, by (2.9),

$$\phi(t, \vec{x}) = \int \dot{D}(t, \vec{x} - \vec{y})\phi(0, \vec{y})d\vec{y} + \int D(t, \vec{x} - \vec{y})\pi(0, \vec{y})d\vec{y}. \quad (2.14)$$

By (2.11), the symplectic form can be written as

$$\zeta_1\omega\zeta_2 = \int (-\langle \pi(t, \vec{x})|\zeta_1\rangle\langle \phi(t, \vec{x})|\zeta_2\rangle + \langle \phi(t, \vec{x})|\zeta_1\rangle\langle \pi(t, \vec{x})|\zeta_2\rangle)d\vec{x},$$

or more simply,

$$\omega = \int \phi(t, \vec{x}) \wedge \pi(t, \vec{x})d\vec{x}.$$

The conserved 4-current can be written as

$$j_\mu(x) = \phi(x) \wedge \partial_\mu\phi(x).$$

2.1.4 Poisson brackets

The symplectic structure on the space \mathcal{Y}_{KG} leads to a *Poisson bracket* on functions on \mathcal{Y}_{KG} :

$$\begin{aligned} \{\phi(t, \vec{x}), \phi(t, \vec{y})\} &= \{\pi(t, \vec{x}), \pi(t, \vec{y})\} = 0, \\ \{\phi(t, \vec{x}), \pi(t, \vec{y})\} &= \delta(\vec{x} - \vec{y}). \end{aligned} \quad (2.15)$$

The relations (2.15) can be viewed as mnemotechnic identities that yield the correct Poisson bracket for more regular functions, eg. the smeared out fields in (2.17) or (2.19) described below. Note that formally $\phi(t, \vec{x})$ and $\pi(t, \vec{x})$ generate the algebra of all functions on \mathcal{Y}_{KG} .

Using (2.14) we obtain

$$\{\phi(x), \phi(y)\} = D(x - y).$$

Therefore, the Pauli-Jordan solution is often called the *commutator function*.

2.1.5 Smeared fields

There are two basic methods to introduce *smeared fields*.

One way to smear them out is to use the *pairing given by the symplectic form*. It is convenient to allow complex smearing functions paired antilinearly. More precisely, for $\zeta \in \mathbb{C}\mathcal{Y}_{\text{KG}}$ we introduce the functional on \mathcal{Y}_{KG} given by

$$\langle \phi((\zeta))|\rho\rangle := \bar{\zeta}\omega\rho, \quad \rho \in \mathcal{Y}_{\text{KG}}.$$

Note in passing that ω can be treated as a linear map from \mathcal{Y}_{KG} to $\mathcal{Y}_{\text{KG}}^\#$, which satisfies

$$-(\omega\bar{\zeta})\rho = \bar{\zeta}\omega\rho.$$

Therefore, a possible alternative notation for $\phi((\zeta))$ is $-\omega\bar{\zeta}$.

Clearly,

$$\phi((\zeta)) = \int \left(-\overline{\dot{\zeta}(t, \vec{x})} \phi(t, \vec{x}) + \overline{\zeta(t, \vec{x})} \pi(t, \vec{x}) \right) d\vec{x}. \quad (2.16)$$

Note that

$$\{\phi((\zeta_1)), \phi((\zeta_2))\} = \bar{\zeta}_1 \omega \bar{\zeta}_2. \quad (2.17)$$

We can also smear fields *with space-time functions*. For $f \in C_c^\infty(\mathbb{R}^{1,3}, \mathbb{R})$, we set

$$\phi[f] := \int f(x) \phi(x) dx.$$

We have

$$\phi[f] = \phi((-D * f)), \quad (2.18)$$

$$\{\phi[f_1], \phi[f_2]\} = \int \int f_1(x) D(x-y) f_2(y) dx dy. \quad (2.19)$$

To see (2.18), write an element of \mathcal{Y}_{KG} as $D * g$ for some $g \in C_c^\infty(\mathbb{R}^{1,3}, \mathbb{R})$:

$$\begin{aligned} \langle \phi((-D * f)) | D * g \rangle &= (D * f) \omega(D * g) = \int f(x) D(x-y) g(y) dx dy \\ &= \int f(x) \langle \phi(x) | D * g \rangle dx = \langle \phi[f] | D * g \rangle. \end{aligned}$$

2.1.6 Lagrangian formalism

In classical mechanics we have the *Hamiltonian formalism*, where the basic object is the phase space equipped with a symplectic form, and the *Lagrangian formalism*, where we start from the configuration space. In classical field theory we can also use both formalisms.

In this context, the Hamiltonian approach is often called the *on-shell formalism*. This means that the field $\phi(x)$ acts on the space of solutions of the equations of motion. In other words, the field $\phi(x)$ that we use in the Hamiltonian formalism satisfies the equation (2.13) – one says that it is *on-shell*.

In the Lagrangian formalism one also uses a classical field, which we will denote by $\phi(x)$, as before. But now, this field is *off-shell*. This means, we do not enforce any equation on $\phi(x)$. One can interpret $\phi(x)$ as the functional on, say, $C^\infty(\mathbb{R}^{1,3})$ or $C_{\text{sc}}^\infty(\mathbb{R}^{1,3})$ such that $\langle \phi(x) | f \rangle := f(x)$.

Using $\phi(x)$ in the off-shell formalism, introduce the *Lagrangian density*

$$\mathcal{L}(x) = -\frac{1}{2} \partial_\mu \phi(x) \partial^\mu \phi(x) - \frac{1}{2} m^2 \phi(x)^2. \quad (2.20)$$

The *Euler-Lagrange equation*

$$\partial_\phi \mathcal{L} - \partial_\mu \frac{\partial \mathcal{L}}{\partial \phi_{,\mu}} = 0 \quad (2.21)$$

yields the Klein-Gordon equation (2.1).

When we go from the Lagrangian to Hamiltonian formalism, we enforce the *on-shell* condition, that is, the Euler-Lagrange equation, and we introduce the variable conjugate to $\phi(x)$:

$$\pi(x) := \frac{\partial \mathcal{L}}{\partial \phi_{,0}(x)} = \phi_{,0}(x).$$

Then we express everything in terms of $\phi(x)$ and $\pi(x)$.

2.1.7 Stress-energy tensor

We can also introduce the *stress-energy tensor*

$$\begin{aligned} \mathcal{T}^{\mu\nu}(x) &:= -\frac{\partial \mathcal{L}(x)}{\partial \phi_{,\mu}(x)} \phi^{,\nu}(x) + g^{\mu\nu} \mathcal{L}(x) \\ &= \partial^\mu \phi(x) \partial^\nu \phi(x) - g^{\mu\nu} \frac{1}{2} (\partial_\alpha \phi(x) \partial^\alpha \phi(x) + m^2 \phi(x)^2). \end{aligned} \quad (2.22)$$

It is easy to check that the stress-energy tensor is conserved for a solution of the Klein-Gordon equation (on shell)

$$\partial_\mu \mathcal{T}^{\mu\nu}(x) = 0.$$

We express the stress-energy tensor in terms of $\phi(x)$ and $\pi(x)$. Its components with the first temporal coordinate are called the *Hamiltonian density* and *momentum density*:

$$\begin{aligned} \mathcal{H}(x) &:= \mathcal{T}^{00}(x) = \frac{1}{2} \left(\pi(x)^2 + (\vec{\partial} \phi(x))^2 + m^2 \phi(x)^2 \right), \\ \mathcal{P}^i(x) &:= \mathcal{T}^{0i}(x) = -\pi(x) \partial^i \phi(x). \end{aligned}$$

They are examples of quadratic functionals on \mathcal{Y}_{KG} :

$$\begin{aligned} \langle \mathcal{H}(x) | \zeta \rangle &= \frac{1}{2} \left(\dot{\zeta}(x)^2 + (\vec{\partial} \zeta(x))^2 + m^2 \zeta(x)^2 \right), \\ \langle \mathcal{P}^i(x) | \zeta \rangle &= -\dot{\zeta}(x) \partial^i \zeta(x). \end{aligned}$$

We introduce the (*total*) *Hamiltonian* and *momentum*:

$$\begin{aligned} H &:= \int_{\mathcal{S}} \mathcal{T}^{\mu 0}(x) ds_\mu(x) = \int \mathcal{H}(t, \vec{x}) d\vec{x}, \\ P^i &:= \int_{\mathcal{S}} \mathcal{T}^{\mu i}(x) ds_\mu(x) = \int \mathcal{P}^i(t, \vec{x}) d\vec{x}. \end{aligned} \quad (2.23)$$

where \mathcal{S} is any Cauchy subspace.

H and \vec{P} are the generators of the time and space translations:

$$\begin{aligned} \dot{\phi}(x) &= \{\phi(x), H\}, \quad \dot{\pi}(x) = \{\pi(x), H\}, \\ \vec{\partial} \phi(x) &= -\{\phi(x), \vec{P}\}, \quad \vec{\partial} \pi(x) = -\{\pi(x), \vec{P}\}. \end{aligned}$$

The observables H , P^1 , P^2 and P^3 are in involution. (This means that the Poisson bracket of every pair among these observables vanishes).

2.1.8 Diagonalization of the equations of motion

For $\vec{k} \in \mathbb{R}^3$, set $\varepsilon = \varepsilon(\vec{k}) := \sqrt{\vec{k}^2 + m^2}$ and $k := (\varepsilon(\vec{k}), \vec{k})$. $k \in \mathbb{R}^{1,3}$ of this form will be called *on shell*. Define

$$\begin{aligned}\phi_t(\vec{k}) &:= \int \phi(t, \vec{x}) e^{-i\vec{k}\vec{x}} d\vec{x}, \\ \pi_t(\vec{k}) &:= \int \pi(t, \vec{x}) e^{-i\vec{k}\vec{x}} d\vec{x}.\end{aligned}$$

Clearly,

$$\begin{aligned}\phi_t^*(\vec{k}) &= \phi_t(-\vec{k}), \\ \pi_t^*(\vec{k}) &= \pi_t(-\vec{k}), \\ \{\phi_t^*(\vec{k}), \phi_t(\vec{k}')\} &= \{\pi_t^*(\vec{k}), \pi_t(\vec{k}')\} = 0, \\ \{\phi_t^*(\vec{k}), \pi_t(\vec{k}')\} &= (2\pi)^3 \delta(\vec{k} - \vec{k}').\end{aligned}$$

The equations of motion are

$$\begin{aligned}\dot{\phi}_t(\vec{k}) &= \pi_t(\vec{k}), \\ \dot{\pi}_t(\vec{k}) &= -\varepsilon^2(\vec{k})\phi_t(\vec{k}).\end{aligned}$$

For k on shell we set

$$\begin{aligned}a_t(k) &= \frac{1}{\sqrt{(2\pi)^3}} \left(\sqrt{\frac{\varepsilon(\vec{k})}{2}} \phi_t(\vec{k}) + \frac{i}{\sqrt{2\varepsilon(\vec{k})}} \pi_t(\vec{k}) \right), \\ a_t^*(k) &= \frac{1}{\sqrt{(2\pi)^3}} \left(\sqrt{\frac{\varepsilon(\vec{k})}{2}} \phi_t^*(\vec{k}) - \frac{i}{\sqrt{2\varepsilon(\vec{k})}} \pi_t^*(\vec{k}) \right).\end{aligned}$$

We have the equations of motion

$$\begin{aligned}\dot{a}_t(k) &= -i\varepsilon(\vec{k})a_t(k), \\ \dot{a}_t^*(k) &= i\varepsilon(\vec{k})a_t^*(k).\end{aligned}$$

We will usually write $a(k)$, $a^*(k)$ instead of $a_0(k)$, $a_0^*(k)$, so that

$$a(k) := \int \frac{d\vec{x}}{\sqrt{(2\pi)^3}} e^{-i\vec{k}\vec{x}} \left(\sqrt{\frac{\varepsilon(\vec{k})}{2}} \phi(0, \vec{x}) + \frac{i}{\sqrt{2\varepsilon(\vec{k})}} \pi(0, \vec{x}) \right), \quad (2.24)$$

$$a^*(k) := \int \frac{d\vec{x}}{\sqrt{(2\pi)^3}} e^{i\vec{k}\vec{x}} \left(\sqrt{\frac{\varepsilon(\vec{k})}{2}} \phi(0, \vec{x}) - \frac{i}{\sqrt{2\varepsilon(\vec{k})}} \pi(0, \vec{x}) \right). \quad (2.25)$$

Thus

$$\begin{aligned} a_t(k) &= e^{-it\varepsilon(\vec{k})}a(k), \\ a_t^*(k) &= e^{it\varepsilon(\vec{k})}a^*(k); \\ \{a(k), H\} &= -i\varepsilon(\vec{k})a(k), \end{aligned} \quad (2.26)$$

$$\{a^*(k), H\} = i\varepsilon(\vec{k})a^*(k); \quad (2.27)$$

$$\{a(k), a(k')\} = \{a^*(k), a^*(k')\} = 0, \quad (2.28)$$

$$\{a(k), a^*(k')\} = -i\delta(\vec{k} - \vec{k}'). \quad (2.29)$$

The fields can be written as

$$\begin{aligned} \phi(x) &= \int \frac{d\vec{k}}{\sqrt{(2\pi)^3}\sqrt{2\varepsilon(\vec{k})}} (e^{ikx}a(k) + e^{-ikx}a^*(k)), \\ \pi(x) &= \int \frac{d\vec{k}\sqrt{\varepsilon(\vec{k})}}{i\sqrt{(2\pi)^3}\sqrt{2}} (e^{ikx}a(k) - e^{-ikx}a^*(k)). \end{aligned}$$

$a(k)$, $a^*(k)$ diagonalize simultaneously the Hamiltonian, momentum and symplectic form:

$$\begin{aligned} H &= \int d\vec{k}\varepsilon(\vec{k})a^*(k)a(k), \\ \vec{P} &= \int d\vec{k}\vec{k}a^*(k)a(k), \\ i\omega &= \int d\vec{k}a^*(k) \wedge a(k). \end{aligned}$$

With $\zeta_1, \zeta_2 \in \mathcal{Y}_{\text{KG}}$, the last identity is the shorthand for

$$i\zeta_1\omega\zeta_2 = \int \left(\overline{\langle a(k)|\zeta_1\rangle} \langle a(k)|\zeta_2\rangle - \langle a(k)|\zeta_1\rangle \overline{\langle a(k)|\zeta_2\rangle} \right) d\vec{k}.$$

2.1.9 Plane waves

Let $k \in \mathbb{R}^{1,3}$ satisfy $k^0 = \varepsilon(\vec{k})$. A *plane wave* $|k\rangle$ is defined as

$$(x|k\rangle = \frac{1}{\sqrt{(2\pi)^3}\sqrt{2\varepsilon(\vec{k})}} e^{ikx}. \quad (2.30)$$

Note that, following Dirac, we denote plane waves using the ‘‘ket notation’’ $|k\rangle$ when they appear on the right of a bilinear form. We also write $(x|k\rangle$ for the evaluation of $|k\rangle$ at the point $x \in \mathbb{R}^{1,3}$. Plane waves are solutions of the Klein-Gordon equation which are not space compact.

If a plane wave appears on the left, we employ the “bra notation”, which implies an additional complex conjugation:

$$(k|x) = \overline{(x|k)} = \frac{1}{\sqrt{(2\pi)^3} \sqrt{2\varepsilon(\vec{k})}} e^{-ikx}.$$

Note that in the neutral case we use only *positive frequency* plane waves, corresponding to $k^0 > 0$.

Let $k = (\varepsilon(\vec{k}), \vec{k})$, $k' = (\varepsilon(\vec{k}'), \vec{k}')$.

$$\begin{aligned} i(\vec{k}|\omega|k') &= i(k|\omega|\vec{k}') = 0, \\ -i(\vec{k}|\omega|\vec{k}') &= i(k|\omega|k') = \delta(\vec{k} - \vec{k}'). \end{aligned}$$

$a(k)$ and $a^*(k)$, defined in (2.24) and (2.25) will be called *plane wave functionals*. They can be expressed as

$$\begin{aligned} a(k) &= i\phi(|k\rangle) \\ &= i \int \left(\partial_t(k|0, \vec{x})\phi(0, \vec{x}) - (k|0, \vec{x})\pi(0, \vec{x}) \right) d\vec{x}, \\ a^*(k) &= -i\phi(|\vec{k}\rangle) \\ &= -i \int \left(\partial_t(\vec{k}|0, \vec{x})\phi(0, \vec{x}) - \overline{(\vec{k}|0, \vec{x})}\pi(0, \vec{x}) \right) d\vec{x}. \end{aligned}$$

The fields can be written in terms of plane waves functionals as

$$\phi(x) = \int \left((x|k)a(k) + \overline{(x|\vec{k})}a^*(k) \right) d\vec{k}.$$

So far we used only the real space \mathcal{Y}_{KG} . We can complexify it and extend $a(k)$ to $\mathbb{C}\mathcal{Y}_{\text{KG}}$ by complex linearity. Every $\zeta \in \mathbb{C}\mathcal{Y}_{\text{KG}}$ satisfies

$$\langle a(k)|\zeta \rangle = i(k|\omega\zeta, \quad (2.31)$$

$$\overline{\langle a(k)|\zeta \rangle} = -i(\vec{k}|\omega\zeta, \quad (2.32)$$

$$\zeta(x) = \int \frac{d\vec{k}}{\sqrt{(2\pi)^3} \sqrt{2\varepsilon(\vec{k})}} \left(e^{ikx} \langle a(k)|\zeta \rangle + e^{-ikx} \overline{\langle a(k)|\zeta \rangle} \right). \quad (2.33)$$

2.1.10 Positive frequency space

$\mathcal{W}_{\text{KG}}^{(\pm)}$ will denote the subspace of $\mathbb{C}\mathcal{Y}_{\text{KG}}$ consisting of *positive*, resp. *negative frequency solutions*, that is,

$$\begin{aligned} \mathcal{W}_{\text{KG}}^{(+)} &:= \{g \in \mathbb{C}\mathcal{Y}_{\text{KG}} : \overline{(\vec{k}|\omega}g = 0\}, \\ \mathcal{W}_{\text{KG}}^{(-)} &:= \overline{\mathcal{W}_{\text{KG}}^{(+)}} = \{g \in \mathbb{C}\mathcal{Y}_{\text{KG}} : (k|\omega}g = 0\}. \end{aligned}$$

In other words, $\mathcal{W}_{\text{KG}}^{(+)}$ is the subspace of $\mathbb{C}\mathcal{Y}_{\text{KG}}$ that consists of functions of the form

$$g(x) = \int \frac{d\vec{k}}{\sqrt{(2\pi)^3} \sqrt{2\varepsilon(\vec{k})}} e^{ikx} \langle a(k)|g \rangle.$$

For $g_1, g_2 \in \mathcal{W}_{\text{KG}}^{(+)}$ we define the scalar product

$$(g_1|g_2) := i\bar{g}_1 \omega g_2 = \int \overline{\langle a(k)|g_1 \rangle} \langle a(k)|g_2 \rangle d\vec{k}. \quad (2.34)$$

The *Hilbert space of positive energy solutions* is denoted \mathcal{Z}_{KG} , and is the completion of $\mathcal{W}_{\text{KG}}^{(+)}$ in this scalar product.

Note that

$$\langle a(k)|g \rangle = (k|g), \quad g \in \mathcal{Z}_{\text{KG}}.$$

We can identify $\mathcal{Z}_{\text{KG}} \simeq L^2(\mathbb{R}^3)$ and rewrite (2.34) as

$$(g_1|g_2) = \int \overline{(k|g_1)} (k|g_2) d\vec{k}. \quad (2.35)$$

$\mathbb{R}^{1,3} \rtimes O^\uparrow(1,3)$ leaves \mathcal{Z}_{KG} invariant.

We have a natural identification of \mathcal{Y}_{KG} with $\mathcal{W}_{\text{KG}}^{(+)}$. Indeed, if $\zeta \in \mathcal{Y}_{\text{KG}}$ is given by (2.33), then we can project it onto $\mathcal{W}_{\text{KG}}^{(+)}$ obtaining

$$\zeta^{(+)}(x) = \int \frac{d\vec{k}}{\sqrt{(2\pi)^3} \sqrt{2\varepsilon(\vec{k})}} e^{ikx} \langle a(k)|\zeta \rangle. \quad (2.36)$$

This identification allows us to define a real scalar product on \mathcal{Y}_{KG} :

$$\langle \zeta_1|\zeta_2 \rangle_{\mathcal{Y}} := \text{Re}(\zeta_1^{(+)}|\zeta_2^{(+)}).$$

We can compute explicitly this scalar product:

$$\begin{aligned} \langle \zeta_1|\zeta_2 \rangle_{\mathcal{Y}} &= \int \int \dot{\zeta}_1(0, \vec{x})(-i)D^{(+)}(0, \vec{x} - \vec{y})\dot{\zeta}_2(0, \vec{y})d\vec{x}d\vec{y} \\ &+ \int \int \zeta_1(0, \vec{x})(-\Delta_{\vec{x}} + m^2)(-i)D^{(+)}(0, \vec{x} - \vec{y})\zeta_2(0, \vec{y})d\vec{x}d\vec{y}. \end{aligned} \quad (2.37)$$

2.1.11 Quantization

Let us describe the quantization of the Klein-Gordon equation, following the formalism of quantization of neutral bosonic systems [15]. We will use the “hat” to denote the quantized objects.

We want to construct $\mathcal{H}, \hat{H}, \Omega$ satisfying the standard requirements of QM (1)-(3) and a self-adjoint operator valued distribution

$$\mathbb{R}^{1,3} \ni x \mapsto \hat{\phi}(x), \quad (2.38)$$

such that, with $\hat{\pi}(x) := \dot{\hat{\phi}}(x)$,

- (1) $(-\square + m^2)\hat{\phi}(x) = 0$,
- (2) $[\hat{\phi}(0, \vec{x}), \hat{\phi}(0, \vec{y})] = [\hat{\pi}(0, \vec{x}), \hat{\pi}(0, \vec{y})] = 0$,
 $[\hat{\phi}(0, \vec{x}), \hat{\pi}(0, \vec{y})] = i\delta(\vec{x} - \vec{y})$.
- (3) $e^{it\hat{H}}\hat{\phi}(x^0, \vec{x})e^{-it\hat{H}} = \hat{\phi}(x^0 + t, \vec{x})$.
- (4) Ω is cyclic for $\hat{\phi}(x)$.

The above problem has a solution, which is essentially unique. Indeed, let $\mathcal{H}, \hat{H}, \Omega, \mathbb{R}^{1,3} \ni x \mapsto \hat{\phi}(x), \hat{\pi}(x)$ solve the above problem. Decorating (2.24) and (2.25) with hats leads to the definitions of two operator valued distributions Hermitian conjugate to one another:

$$\hat{a}(k) := \int \frac{d\vec{x}}{\sqrt{(2\pi)^3}} e^{-i\vec{k}\vec{x}} \left(\sqrt{\frac{\varepsilon(\vec{k})}{2}} \hat{\phi}(0, \vec{x}) + \frac{i}{\sqrt{2\varepsilon(\vec{k})}} \hat{\pi}(0, \vec{x}) \right), \quad (2.39)$$

$$\hat{a}^*(k) := \int \frac{d\vec{x}}{\sqrt{(2\pi)^3}} e^{i\vec{k}\vec{x}} \left(\sqrt{\frac{\varepsilon(\vec{k})}{2}} \hat{\phi}(0, \vec{x}) - \frac{i}{\sqrt{2\varepsilon(\vec{k})}} \hat{\pi}(0, \vec{x}) \right). \quad (2.40)$$

Using (2) and (3) we obtain the quantized versions of (2.26)-(2.29):

$$[\hat{a}(k), \hat{H}] = \varepsilon(\vec{k})\hat{a}(k), \quad (2.41)$$

$$[\hat{a}^*(k), \hat{H}] = -\varepsilon(\vec{k})\hat{a}^*(k), \quad (2.42)$$

$$[\hat{a}(k), \hat{a}(k')] = [\hat{a}^*(k), \hat{a}^*(k')] = 0, \quad (2.43)$$

$$[\hat{a}(k), \hat{a}^*(k')] = \delta(\vec{k} - \vec{k}'). \quad (2.44)$$

$\hat{H}\Omega = 0$ implies $\hat{H}\hat{a}(k)\Omega = -\varepsilon(\vec{k})\hat{a}(k)\Omega$. But $\hat{H} \geq 0$. Thus we should assume

$$\hat{a}(k)\Omega = 0. \quad (2.45)$$

By (4), Ω is cyclic for $\hat{a}(k)$ and $\hat{a}^*(k)$. Using (2.41), (2.44) and (2.45) we see that Ω is cyclic just for $\hat{a}^*(k)$. In other words, \mathcal{H} is spanned by vectors of the form

$$\int \Psi(\vec{k}_1, \dots, \vec{k}_n) \hat{a}^*(k_1) \cdots \hat{a}^*(k_n) \Omega d\vec{k}_1 \cdots d\vec{k}_n.$$

Using again (2.41), (2.44) and (2.45) we see that the scalar product of two vectors Ψ, Ψ' is zero if $n \neq n'$, and otherwise it is

$$(\Psi|\Psi') = \int \overline{\Psi(\vec{k}_1, \dots, \vec{k}_n)} \Psi'(\vec{k}_1, \dots, \vec{k}_n) d\vec{k}_1 \cdots d\vec{k}_n.$$

Therefore, \mathcal{H} can be identified with $\Gamma_s(L^2(\mathbb{R}^3))$, Ω with the Fock vacuum, $\hat{a}^*(k)$ with the creation operators in the ‘‘physicist’s notation’’, the quantum field is

$$\hat{\phi}(x) := \int \frac{d\vec{k}}{\sqrt{(2\pi)^3} \sqrt{2\varepsilon(\vec{k})}} (e^{ikx} \hat{a}(k) + e^{-ikx} \hat{a}^*(k)),$$

finally, the quantum Hamiltonian and the momentum are

$$\begin{aligned}\hat{H} &:= \int \hat{a}^*(k)\hat{a}(k)\varepsilon(\vec{k})d\vec{k}, \\ \vec{\hat{P}} &:= \int \hat{a}^*(k)\hat{a}(k)\vec{k}d\vec{k}.\end{aligned}$$

By (2.34) we can identify $L^2(\mathbb{R}^3)$ with the positive frequency Hilbert space \mathcal{Z}_{KG} . Using the “mathematician’s notation” on the right we can write

$$\hat{a}^*(k) = \hat{a}^*(|k|). \quad (2.46)$$

Note that the whole $\mathbb{R}^{1,3} \rtimes O^\uparrow(1,3)$ is unitarily implemented on \mathcal{H} by $U(y, \Lambda) := \Gamma\left(r_{(y, \Lambda)} \Big|_{\mathcal{Z}_{\text{KG}}}\right)$:

$$U(y, \Lambda)\hat{\phi}(x)U(y, \Lambda)^* = \hat{\phi}((y, \Lambda)x).$$

This is true even though we only required that time translations are implemented.

We have

$$[\hat{\phi}(x), \hat{\phi}(y)] = -iD(x - y).$$

For $f \in C_c^\infty(\mathbb{R}^{1,3}, \mathbb{R})$ set

$$\hat{\phi}[f] := \int f(x)\hat{\phi}(x)dx. \quad (2.47)$$

(2.47) satisfy the Wightman axioms with $\mathcal{D} := \Gamma_s^{\text{fin}}(\mathcal{Z}_{\text{KG}})$.

For an open set $\mathcal{O} \subset \mathbb{R}^d$ we set

$$\mathfrak{A}(\mathcal{O}) := \{\exp(i\hat{\phi}[f]) : f \in C_c^\infty(\mathcal{O}, \mathbb{R})\}''.$$

The algebras $\mathfrak{A}(\mathcal{O})$ satisfy the Haag-Kastler axioms.

2.1.12 Quantization in terms of smeared fields

There exists an alternative equivalent formulation of the quantization program, which uses smeared fields instead of point fields, which may better appeal to some people.

Again, we want to construct $\mathcal{H}, \hat{H}, \Omega$ satisfying the standard requirements of QM (1)-(3). Instead of (2.38) we look for a linear function

$$\mathcal{Y}_{\text{KG}} \ni \zeta \mapsto \hat{\phi}((\zeta))$$

with values in self-adjoint operators such that

$$(1) \quad [\hat{\phi}((\zeta_1)), \hat{\phi}((\zeta_2))] = i\zeta_1 \omega \zeta_2. \quad (2.48)$$

$$(2) \quad \hat{\phi}((r_{(t, \vec{0})}\zeta)) = e^{it\hat{H}} \hat{\phi}((\zeta)) e^{-it\hat{H}}.$$

(3) Ω is cyclic for the algebra generated by $\hat{\phi}(\zeta)$.

One can pass between these two versions of the quantization by

$$\hat{\phi}(\zeta) = \int \left(-\dot{\zeta}(t, \vec{x}) \hat{\phi}(t, \vec{x}) + \zeta(t, \vec{x}) \hat{\pi}(t, \vec{x}) \right) d\vec{x}. \quad (2.49)$$

2.1.13 Quantization in terms of C^* -algebras

Let us mention yet another equivalent approach to quantization, using the language of C^* -algebras.

Let $\text{CCR}(\mathcal{Y}_{\text{KG}})$ denote the (Weyl) C^* -algebra of the CCR over \mathcal{Y}_{KG} . By definition, it is generated by $W(\zeta)$, $\zeta \in \mathcal{Y}_{\text{KG}}$, such that

$$W(\zeta_1)W(\zeta_2) = e^{-i\frac{\zeta_1 \omega \zeta_2}{2}} W(\zeta_1 + \zeta_2), \quad W(\zeta)^* = W(-\zeta).$$

$\mathbb{R}^{1,3} \rtimes O^\uparrow(1,3)$ acts on $\text{CCR}(\mathcal{Y}_{\text{KG}})$ by $*$ -automorphisms defined by

$$\hat{r}_{(y,\Lambda)}(W(\zeta)) := W(r_{(y,\Lambda)}(\zeta)).$$

We are looking for a cyclic representation of this algebra with the time evolution generated by a positive Hamiltonian.

The solution is provided by the state on $\text{CCR}(\mathcal{Y}_{\text{KG}})$ defined by

$$\psi(W(\zeta)) = \exp\left(-\frac{1}{2}\langle \zeta | \zeta \rangle_{\mathcal{Y}}\right).$$

Let $(\mathcal{H}_\psi, \pi_\psi, \Omega_\psi)$ be the GNS representation generated by the state ψ . Then this representation has the required properties. \mathcal{H}_ψ can be identified with $\Gamma_s(\mathcal{Z}_{\text{KG}})$ and the fields are related to the Weyl operators by

$$\pi_\psi(W(\zeta)) = e^{i\hat{\phi}(\zeta)}.$$

2.1.14 Two-point functions

Note the identities

$$(\Omega | \hat{\phi}(x) \hat{\phi}(y) \Omega) = -iD^{(+)}(x-y), \quad (2.50)$$

$$(\Omega | \mathbb{T}(\hat{\phi}(x) \hat{\phi}(y)) \Omega) = -iD^c(x-y). \quad (2.51)$$

In fact,

$$\begin{aligned} (\Omega | \hat{\phi}(x) \hat{\phi}(y) \Omega) &= \int \int \frac{d\vec{k} d\vec{k}'}{(2\pi)^3 \sqrt{2\varepsilon} \sqrt{2\varepsilon'}} e^{ikx - ik'y} (\Omega | \hat{a}(k) \hat{a}^*(k') \Omega) \\ &= \int \frac{d\vec{k}}{(2\pi)^3 2\varepsilon(\vec{k})} e^{ik(x-y)} \\ &= -iD^{(+)}(x-y); \\ (\Omega | \mathbb{T}(\hat{\phi}(x) \hat{\phi}(y)) \Omega) &= \theta(x^0 - y^0) (\Omega | \hat{\phi}(x) \hat{\phi}(y) \Omega) + \theta(y^0 - x^0) (\Omega | \hat{\phi}(y) \hat{\phi}(x) \Omega) \\ &= -i\theta(x^0 - y^0) D^{(+)}(x-y) - i\theta(y^0 - x^0) D^{(+)}(y-x) \\ &= -iD^c(x-y). \end{aligned}$$

(2.50) implies the following identities for spacetime smeared fields and Weyl operators:

$$(\Omega|\hat{\phi}[f]^2\Omega) = -i \int \int f(x)D^{(+)}(x-y)f(y)dxdy, \quad (2.52)$$

$$(\Omega|e^{i\hat{\phi}[f]}\Omega) = \exp\left(\frac{i}{2} \int \int f(x)D^{(+)}(x-y)f(y)dxdy\right). \quad (2.53)$$

Differentiating if needed (2.50) with respect time we obtain the equal time correlation functions expressed as real symmetric kernels:

$$(\Omega|\hat{\phi}(0, \vec{x})\hat{\phi}(0, \vec{y})\Omega) = -iD^{(+)}(0, \vec{x} - \vec{y}), \quad (2.54)$$

$$(\Omega|\hat{\phi}(0, \vec{x})\hat{\pi}(0, \vec{y})\Omega) = 0, \quad (2.55)$$

$$\begin{aligned} (\Omega|\hat{\pi}(0, \vec{x})\hat{\pi}(0, \vec{y})\Omega) &= i\partial_t^2 D^{(+)}(0, \vec{x} - \vec{y}) \\ &= -i(-\Delta_{\vec{x}} + m^2)D^{(+)}(0, \vec{x} - \vec{y}). \end{aligned} \quad (2.56)$$

This yields the identities for spatially smeared fields and Weyl operators, where the scalar product $\langle \cdot | \cdot \rangle_{\mathcal{Y}}$ on \mathcal{Y}_{KG} was introduced in (2.37):

$$\begin{aligned} (\Omega|\hat{\phi}(\zeta)^2\Omega) &= -i \int \int \zeta(0, \vec{x})D^{(+)}(0, \vec{x} - \vec{y})\zeta(0, \vec{y})d\vec{x}d\vec{y} \\ &\quad -i \int \int \zeta(0, \vec{x})(-\Delta_{\vec{x}} + m^2)D^{(+)}(0, \vec{x} - \vec{y})\zeta(0, \vec{y})d\vec{x}d\vec{y} \\ &= \langle \zeta | \zeta \rangle_{\mathcal{Y}}, \end{aligned} \quad (2.57)$$

$$(\Omega|e^{i\hat{\phi}(\zeta)}\Omega) = \exp\left(-\frac{1}{2}\langle \zeta | \zeta \rangle_{\mathcal{Y}}\right). \quad (2.58)$$

2.2 Neutral scalar bosons with a linear source

2.2.1 Classical fields

We go back to the classical theory. The fields studied in the previous subsection will be called *free fields*. We change slightly the notation: free classical fields will be now denoted by $\phi_{\text{fr}}(x)$, $\pi_{\text{fr}}(x)$. Clearly, they satisfy

$$\begin{aligned} (-\square + m^2)\phi_{\text{fr}}(x) &= 0, \\ \pi_{\text{fr}}(x) &= \dot{\phi}_{\text{fr}}(x). \end{aligned} \quad (2.59)$$

Fix a function

$$\mathbb{R}^{1,3} \ni x \mapsto j(x) \in \mathbb{R}, \quad (2.60)$$

which will be called the (*external*) *linear source*. In most of this subsection we will assume that (2.60) is Schwartz. The *interacting fields* satisfy the equation

$$(-\square + m^2)\phi(x) = -j(x), \quad (2.61)$$

$$\pi(x) = \dot{\phi}(x). \quad (2.62)$$

We also require that the interacting fields have the same equal-time Poisson brackets as the free fields:

$$\begin{aligned}\{\phi(t, \vec{x}), \phi(t, \vec{y})\} &= \{\pi(t, \vec{x}), \pi(t, \vec{y})\} = 0, \\ \{\phi(t, \vec{x}), \pi(t, \vec{y})\} &= \delta(\vec{x} - \vec{y}).\end{aligned}\quad (2.63)$$

There are several, usually equivalent, ways to introduce interacting fields.

One way is to treat them as functionals on the space of solutions to the free Klein-Gordon equation, \mathcal{Y}_{KG} . We can demand in addition that

$$\begin{aligned}\phi(\vec{x}) &:= \phi_{\text{fr}}(0, \vec{x}) = \phi(0, \vec{x}), \\ \pi(\vec{x}) &:= \pi_{\text{fr}}(0, \vec{x}) = \pi(0, \vec{x}).\end{aligned}\quad (2.64)$$

This condition determines the field $\phi(x)$ uniquely:

$$\begin{aligned}\phi(x) &:= \phi_{\text{fr}}(x) \\ &+ \int (D^+(x-y)\theta(y^0) + D^-(x-y)\theta(-y^0))j(y)dy.\end{aligned}\quad (2.65)$$

Let us mention some alternative ways to define the interacting fields $\phi(x)$. First of all, there is nothing special about the time $t = 0$ in (2.64) – we can replace it with any $t = t_0$. Alternatively, we can demand

$$\begin{aligned}\lim_{t \rightarrow \infty} (\phi_{\text{fr}}(t, \vec{x}) - \phi(t, \vec{x})) &= 0, & \lim_{t \rightarrow \infty} (\pi_{\text{fr}}(t, \vec{x}) - \pi(t, \vec{x})) &= 0, \\ \text{or } \lim_{t \rightarrow -\infty} (\phi_{\text{fr}}(t, \vec{x}) - \phi(t, \vec{x})) &= 0, & \lim_{t \rightarrow -\infty} (\pi_{\text{fr}}(t, \vec{x}) - \pi(t, \vec{x})) &= 0.\end{aligned}$$

Another possibility is to introduce $\mathcal{Y}_{\text{KG}}(j)$, the space of smooth real space-compact solutions of

$$(-\square + m^2)\zeta(x) = -j(x),\quad (2.66)$$

and define $\phi(x)$ by

$$\langle \phi(x) | \zeta \rangle := \zeta(x), \quad \zeta \in \mathcal{Y}_{\text{KG}}(j).$$

2.2.2 Lagrangian and Hamiltonian formalism

We can obtain the equations (2.61) as the Euler-Lagrange equations for the *Lagrangian density*

$$\mathcal{L}(x) = -\frac{1}{2}\partial_\mu\phi(x)\partial^\mu\phi(x) - \frac{1}{2}m^2\phi(x)^2 - j(x)\phi(x).\quad (2.67)$$

The conjugate variable is

$$\pi(x) := \frac{\partial\mathcal{L}}{\partial\phi_{,0}(x)} = \partial_0\phi(x),$$

just as in the free case.

The Legendre transformation leads to the *Hamiltonian density*

$$\mathcal{H}(x) := \frac{1}{2}\left(\pi(x)^2 + (\vec{\partial}\phi(x))^2 + m^2\phi(x)^2\right) + j(x)\phi(x).$$

and the (time-dependent) *Hamiltonian*

$$\begin{aligned} H(t) &= \int \mathcal{H}(t, \vec{x}) d\vec{x} \\ &= \int d\vec{x} \left(\frac{1}{2} \pi(t, \vec{x})^2 + \frac{1}{2} (\vec{\partial} \phi(t, \vec{x}))^2 + \frac{m^2}{2} \phi(t, \vec{x})^2 + j(t, \vec{x}) \phi(t, \vec{x}) \right). \end{aligned} \quad (2.68)$$

The Hamiltonian generates the dynamics:

$$\dot{\phi}(t, \vec{x}) = \{\phi(t, \vec{x}), H(t)\}, \quad \dot{\pi}(t, \vec{x}) = \{\pi(t, \vec{x}), H(t)\}. \quad (2.69)$$

In (2.68) and (2.69), $H(t)$, $\phi(t, \vec{x})$ and $\pi(t, \vec{x})$ should be understood as the functions of the initial conditions at $t = 0$. Therefore, we use the Lagrangian description (see Subsubsect. 1.3.2).

We can also introduce the Hamiltonian in the Eulerian description, which is convenient for quantization. It uses the fields $\phi(\vec{x})$ and $\pi(\vec{x})$ introduced in (2.64):

$$H_{\text{Eul}}(t) = \int d\vec{x} \left(\frac{1}{2} \pi(\vec{x})^2 + \frac{1}{2} (\vec{\partial} \phi(\vec{x}))^2 + \frac{m^2}{2} \phi(\vec{x})^2 + j(t, \vec{x}) \phi(\vec{x}) \right).$$

2.2.3 Quantization

We will use the notation $\hat{\phi}_{\text{fr}}(x)$ for the *free quantum fields* studied in the previous subsection. We are now looking for *interacting quantum fields* $\hat{\phi}(x)$ satisfying

$$(-\square + m^2) \hat{\phi}(x) = -j(x). \quad (2.70)$$

We also set

$$\hat{\pi}(x) := \dot{\hat{\phi}}(x) \quad (2.71)$$

and require the equal time commutation relations

$$\begin{aligned} [\hat{\phi}(t, \vec{x}), \hat{\phi}(t, \vec{y})] &= [\hat{\pi}(t, \vec{x}), \hat{\pi}(t, \vec{y})] = 0, \\ [\hat{\phi}(t, \vec{x}), \hat{\pi}(t, \vec{y})] &= i\delta(\vec{x} - \vec{y}). \end{aligned} \quad (2.72)$$

We would like to solve (2.70) and (2.72) in terms of free fields. That means, we are looking for $\hat{\phi}(x)$ on the Hilbert space of the free Klein-Gordon fields, $\Gamma_s(\mathcal{Z}_{\text{KG}})$. We will in addition demand that the interacting and free fields at time $t = 0$ coincide:

$$\begin{aligned} \hat{\phi}(\vec{x}) &:= \hat{\phi}(0, \vec{x}) = \hat{\phi}_{\text{fr}}(0, \vec{x}), \\ \hat{\pi}(\vec{x}) &:= \hat{\pi}(0, \vec{x}) = \hat{\pi}_{\text{fr}}(0, \vec{x}). \end{aligned} \quad (2.73)$$

Clearly, the unique solution is obtained by decorating (2.65) with hats:

$$\begin{aligned} \hat{\phi}(x) &:= \hat{\phi}_{\text{fr}}(x) \\ &+ \int \left(D^+(x-y)\theta(y^0) + D^-(x-y)\theta(-y^0) \right) j(y) dy. \end{aligned} \quad (2.74)$$

It can be written as

$$\hat{\phi}(t, \vec{x}) = \text{Texp} \left(-i \int_t^0 \hat{H}(s) ds \right) \hat{\phi}(0, \vec{x}) \text{Texp} \left(-i \int_0^t \hat{H}(s) ds \right), \quad (2.75)$$

where the the Schrödinger picture Hamiltonian is

$$\hat{H}(t) := \int d\vec{x} : \left(\frac{1}{2} \hat{\pi}^2(\vec{x}) + \frac{1}{2} \partial_i \hat{\phi}(\vec{x}) \partial_i \hat{\phi}(\vec{x}) + \frac{m^2}{2} \hat{\phi}^2(\vec{x}) + j(t, \vec{x}) \hat{\phi}(\vec{x}) \right) :. \quad (2.76)$$

Note that $\hat{H}(t)$ is obtained from $H_{\text{Eul}}(t)$ by the Wick quantization A.1.3, which is expressed by decorating the fields with “hats” and putting the “double dots”.

In principle, one could replace $\hat{H}(t)$ by $\hat{H}(t) + C(t)$ for any real function $t \mapsto C(t)$. The choice that we made satisfies

$$(\Omega | \hat{H}(t) \Omega) = 0, \quad t \in \mathbb{R}. \quad (2.77)$$

Condition (2.77) is quite arbitrary – the vector Ω is the ground state of of the free Hamiltonian at time zero – in particular, it depends on the choice $t = 0$ in (2.73).

We also have the interaction picture Hamiltonian

$$\hat{H}_{\text{Int}}(t) = \int j(t, \vec{x}) \hat{\phi}_{\text{fr}}(t, \vec{x}) d\vec{x}. \quad (2.78)$$

2.2.4 Operator valued source

So far we assumed that $j(x)$ is a c-number. Most of the formalism works, at least formally, for *operator valued sources*. The main additional difficulty is the need to distinguish between the source in various pictures.

Let us start with the Schrödinger picture. Let $\mathbb{R}^{1,3} \ni x \mapsto \hat{j}(x)$ be an operator-valued function (or distribution) that commutes with time zero fields:

$$[\hat{\phi}(\vec{x}), \hat{j}(t, \vec{y})] = [\hat{\pi}(\vec{x}), \hat{j}(t, \vec{y})] = 0, \quad \vec{x}, \vec{y} \in \mathbb{R}^3, \quad t \in \mathbb{R}.$$

Define the *the Schrödinger picture Hamiltonian* $\hat{H}(t)$ by (2.76), where $j(x)$ is replaced by $\hat{j}(x)$.

Then we define the *the Heisenberg picture fields* $\hat{\phi}(x)$, $\hat{\pi}(x)$, as in (2.75). We also have the *source in the Heisenberg picture*

$$\hat{j}_{\text{HP}}(t, \vec{x}) := \text{Texp} \left(-i \int_t^0 \hat{H}(s) ds \right) \hat{j}(t, \vec{x}) \text{Texp} \left(-i \int_0^t \hat{H}(s) ds \right)$$

having the commutation relations

$$[\hat{\phi}(t, \vec{x}), \hat{j}_{\text{HP}}(t, \vec{y})] = [\hat{\pi}(t, \vec{x}), \hat{j}_{\text{HP}}(t, \vec{y})] = 0.$$

The Klein-Gordon equation (2.70) and the relation (2.74) generalize:

$$\begin{aligned} (-\square + m^2) \hat{\phi}(x) &= -\hat{j}_{\text{HP}}(x), \\ \hat{\phi}(x) &:= \hat{\phi}_{\text{fr}}(x) \\ &+ \int \left(D^+(x-y) \theta(y^0) + D^-(x-y) \theta(-y^0) \right) \hat{j}_{\text{HP}}(y) dy. \end{aligned} \quad (2.79)$$

We can also introduce the *source in the interaction picture*

$$\hat{j}_{\text{Int}}(t, \vec{x}) := e^{it\hat{H}_{\text{fr}}} \hat{j}(t, \vec{x}) e^{-it\hat{H}_{\text{fr}}},$$

satisfying the commutation relations

$$[\hat{\phi}_{\text{fr}}(t, \vec{x}), \hat{j}_{\text{Int}}(t, \vec{y})] = [\hat{\pi}_{\text{fr}}(t, \vec{x}), \hat{j}_{\text{Int}}(t, \vec{y})] = 0, \quad \vec{x}, \vec{y} \in \mathbb{R}^3, \quad t \in \mathbb{R}.$$

The *interaction picture Hamiltonian* is

$$\hat{H}_{\text{Int}}(t) = \int \hat{j}_{\text{Int}}(t, \vec{x}) \hat{\phi}_{\text{fr}}(t, \vec{x}) d\vec{x},$$

which is obtained from (2.78) by replacing $j(t, \vec{x})$ with $\hat{j}_{\text{Int}}(t, \vec{x})$.

2.2.5 Scattering operator

We go back to a c -number source $j(x)$. The interaction picture Hamiltonian written in terms of creation and annihilation operators equals

$$\hat{H}_{\text{Int}}(t) = \int \frac{d\vec{k}}{\sqrt{(2\pi)^3} \sqrt{2\varepsilon(\vec{k})}} \left(e^{-it\varepsilon(\vec{k})} \overline{j(t, \vec{k})} \hat{a}(k) + e^{it\varepsilon(\vec{k})} j(t, \vec{k}) \hat{a}^*(k) \right).$$

The *scattering operator* (1.57) can be computed exactly. On the level of creation and annihilation operators it acts as

$$\hat{S} \hat{a}^*(k) \hat{S}^* = \hat{a}^*(k) - i \frac{j(\varepsilon(\vec{k}), \vec{k})}{\sqrt{(2\pi)^3} \sqrt{2\varepsilon(\vec{k})}}, \quad (2.80)$$

$$\hat{S} \hat{a}(k) \hat{S}^* = \hat{a}(k) + i \frac{\overline{j(\varepsilon(\vec{k}), \vec{k})}}{\sqrt{(2\pi)^3} \sqrt{2\varepsilon(\vec{k})}}. \quad (2.81)$$

We have an explicit formula:

$$\begin{aligned} \hat{S} &= \exp \left(\frac{i}{2} \int \frac{|j(k)|^2}{(k^2 + m^2 - i0)} \frac{dk}{(2\pi)^4} \right) \\ &\times \exp \left(-i \int \frac{j(\varepsilon(\vec{k}), \vec{k})}{\sqrt{2\varepsilon(\vec{k})}} \hat{a}^*(k) \frac{d\vec{k}}{\sqrt{(2\pi)^3}} \right) \exp \left(-i \int \frac{\overline{j(\varepsilon(\vec{k}), \vec{k})}}{\sqrt{2\varepsilon(\vec{k})}} \hat{a}(k) \frac{d\vec{k}}{\sqrt{(2\pi)^3}} \right). \end{aligned} \quad (2.82)$$

To see this, we insert $f(t, \vec{k}) := -e^{it\varepsilon(\vec{k})} \frac{j(t, \vec{k})}{\sqrt{(2\pi)^3} \sqrt{2\varepsilon(\vec{k})}}$ into (A.10). In particular, the exponent of (A.10) becomes:

$$\begin{aligned}
& - \int \int \frac{e^{i(t_2-t_1)\varepsilon(\vec{k})} \theta(t_1-t_2) \overline{j(t_1, \vec{k})} j(t_2, \vec{k}) dt_1 dt_2}{2\varepsilon(\vec{k})} \frac{d\vec{k}}{(2\pi)^3} \\
&= i \int \int \frac{|j(k^0, \vec{k})|^2 dk^0 d\vec{k}}{2\varepsilon(\vec{k})(\varepsilon(\vec{k})-k^0-i0)} \frac{dk^0}{2\pi} \frac{d\vec{k}}{(2\pi)^3} \\
&= \frac{i}{2} \int \int \frac{|j(k)|^2}{2\varepsilon(\vec{k})} \left(\frac{1}{(\varepsilon(\vec{k})-k^0-i0)} + \frac{1}{(\varepsilon(\vec{k})+k^0-i0)} \right) \frac{dk}{(2\pi)^4} \\
&= \frac{i}{2} \int \int \frac{|j(k)|^2}{(\varepsilon(\vec{k})^2 - (k^0)^2 - i0)} \frac{dk}{(2\pi)^4}.
\end{aligned}$$

Note that we used $\overline{j(k^0, \vec{k})} = j(-k^0, -\vec{k})$

For distinct k_1, \dots, k_n on shell, set

$$|k_n, \dots, k_1\rangle := \hat{a}^*(k_n) \cdots \hat{a}^*(k_1) \Omega.$$

Matrix elements of the scattering operator between such vectors are called *scattering amplitudes*:

$$\begin{aligned}
& \left(k_1^+, \dots, k_{n^+}^+ | \hat{S} | k_{n^-}^-, \dots, k_1^- \right) \tag{2.83} \\
&= \exp \left(\frac{i}{2} \int \frac{|j(k)|^2}{(k^2 + m^2 - i0)} \frac{dk}{(2\pi)^4} \right) \frac{(-i)^{n^+ + n^-}}{\sqrt{(2\pi)^{3(n^+ + n^-)}}} \\
&\quad \times \frac{j(\varepsilon(\vec{k}_1^+), \vec{k}_1^+)}{\sqrt{2\varepsilon(\vec{k}_1^+)}} \cdots \frac{j(\varepsilon(\vec{k}_{n^+}^+), \vec{k}_{n^+}^+)}{\sqrt{2\varepsilon(\vec{k}_{n^+}^+)}} \frac{\overline{j(\varepsilon(\vec{k}_{n^-}^-), \vec{k}_{n^-}^-)}}{\sqrt{2\varepsilon(\vec{k}_{n^-}^-)}} \cdots \frac{\overline{j(\varepsilon(\vec{k}_1^-), \vec{k}_1^-)}}{\sqrt{2\varepsilon(\vec{k}_1^-)}}.
\end{aligned}$$

2.2.6 Green's functions

Recall that the N -point *Green's function* is defined for x_N, \dots, x_1 as follows:

$$\begin{aligned}
& \langle \hat{\phi}(x_N) \cdots \hat{\phi}(x_1) \rangle \\
&:= \left(\Omega^+ | \mathbb{T}(\hat{\phi}(x_N) \cdots \hat{\phi}(x_1)) \Omega^- \right), \tag{2.84}
\end{aligned}$$

where

$$\begin{aligned}
\Omega^\pm &:= \lim_{t \rightarrow \pm\infty} \text{Texp} \left(-i \int_0^t \hat{H}(s) ds \right) \Omega \\
&= \text{Texp} \left(-i \int_0^{\pm\infty} \hat{H}_{\text{Int}}(s) ds \right) \Omega.
\end{aligned}$$

One can organize Green's functions in terms of the *generating function*:

$$\begin{aligned}
Z(f) &= \sum_{N=0}^{\infty} \int \cdots \int \frac{(-i)^N}{N!} \langle \hat{\phi}(x_N) \cdots \hat{\phi}(x_1) \rangle f(x_N) \cdots f(x_1) dx_N \cdots dx_1 \\
&= \left(\Omega^+ \left| \text{Texp} \left(-i \int_{-\infty}^{\infty} \left(\hat{H}(t) + \int f(t, \vec{x}) \hat{\phi}(\vec{x}) d\vec{x} \right) dt \right) \Omega^- \right. \right) \\
&= \left(\Omega \left| \text{Texp} \left(-i \int_{-\infty}^{\infty} \hat{H}_{\text{Int}}(t) dt - i \int f(x) \hat{\phi}_{\text{fr}}(x) dx \right) \Omega \right. \right) \\
&= \exp \left(\frac{i}{2} \int \frac{|j(k) + f(k)|^2}{(k^2 + m^2 - i0)} \frac{dk}{(2\pi)^4} \right). \tag{2.85}
\end{aligned}$$

One can retrieve Green's functions from the generating function:

$$\langle \hat{\phi}(x_N) \cdots \hat{\phi}(x_1) \rangle = i^N \frac{\partial^N}{\partial f(x_N) \cdots \partial f(x_1)} Z(f) \Big|_{f=0}. \tag{2.86}$$

We introduce also *amputated Green's functions*:

$$\begin{aligned}
&\langle \hat{\phi}(k_n) \cdots \hat{\phi}(k_1) \rangle_{\text{amp}} \\
&= (k_n^2 + m^2) \cdots (k_1^2 + m^2) \langle \hat{\phi}(k_n) \cdots \hat{\phi}(k_1) \rangle. \tag{2.87}
\end{aligned}$$

Amputated Green's functions can be used to compute scattering amplitudes:

$$\begin{aligned}
&(k_{n^+}^+, \dots, k_1^+ | \hat{S} | k_{n^-}^-, \dots, k_1^-) \tag{2.88} \\
&= \frac{\langle \hat{\phi}(k_1^+) \cdots \hat{\phi}(k_{n^+}^+) \hat{\phi}(-k_{n^-}^-) \cdots \hat{\phi}(-k_1^-) \rangle_{\text{amp}}}{\sqrt{(2\pi)^{3(n^+ + n^-)}} \sqrt{2\varepsilon(k_1^+)} \cdots \sqrt{2\varepsilon(k_{n^+}^+)} \sqrt{2\varepsilon(k_{n^-}^-)} \cdots \sqrt{2\varepsilon(k_1^-)}},
\end{aligned}$$

where all k_i^\pm are on shell.

2.2.7 Path integral formulation

Recall that the generating function equals

$$\begin{aligned}
Z(f) &= \exp \left(\frac{i}{2} \int (j(x) + f(x)) D^c(x-y) (j(y) + f(y)) dx dy \right) \\
&= \exp \left(\frac{i}{2} \int \frac{|j(k) + f(k)|^2}{(k^2 + m^2 - i0)} \frac{dk}{(2\pi)^4} \right). \tag{2.89}
\end{aligned}$$

We have the following expressions for the *action integral*:

$$\begin{aligned}
\int \mathcal{L}_{\text{fr}}(x) dx &= - \int \frac{1}{2} \phi(x) (-\square + m^2) \phi(x) dx, \\
\int (\mathcal{L}(x) - \phi(x) f(x)) dx &= \int \mathcal{L}_{\text{fr}}(x) dx - \int \phi(x) (j(x) + f(x)) dx.
\end{aligned}$$

Consider heuristically the space of all (off-shell) configurations with the Lebesgue measure $\prod_x d\phi(x)$. Physicists like to rewrite (2.89) as

$$Z(f) = \frac{\int \prod_x d\phi(x) \exp(i \int (\mathcal{L}(x) - f(x)\phi(x)) dx)}{\int \prod_x d\phi(x) \exp(i \int \mathcal{L}_{\text{fr}}(x) dx)}, \quad (2.90)$$

which follows by basic rules of Gaussian integrals. Note that strictly speaking (2.90) is ambiguous, since D^c , the causal propagator, is only one of many inverses (Green's functions) of $-\square + m^2$. The choice of the causal propagator is an additional convention that is not explicitly contained in the expression (2.90).

2.2.8 Feynman rules

Perturbative expansions can be organized in terms of Feynman diagrams. The prescriptions how to draw Feynman diagrams and to evaluate them are called *Feynman rules*. We restrict ourselves to Feynman rules in the momentum space.

We have 1 kind of *lines* and 1 kind of *vertices*. At each vertex just one line ends. Vertices are denoted by solid dots. Lines have no distinguished orientation. However, when we fix the orientation of a line, we can associate to it a momentum k .

Diagrams for Green's functions, in addition to *internal lines* have *external lines* ending with *insertion vertices*, which will be denoted by small circles. To compute Green's functions we do as follows:

- (1) We draw all possible Feynman diagrams. More precisely, we put N dots for insertion vertices, labelled $1, \dots, N$. We put n dots, labelled $1, \dots, n$, for interaction vertices. Then we connect them in all possible allowed ways. The expression for the diagram is then divided by $n!$.
- (2) To each vertex we associate the factor $-ij(k)$, where k is the momentum flowing towards this vertex.
- (3) To each line we associate the propagator

$$-iD_{\text{fr}}^c(k) = \frac{-i}{k^2 + m^2 - i0}.$$

- (4) For internal lines we integrate over the variables with the measure $\frac{d^4 k}{(2\pi)^4}$.

Diagrams used to compute scattering amplitudes with N^- incoming and N^+ outgoing particles are similar to diagrams for $N^- + N^+$ -point Green's functions, except that instead of insertion vertices we have *incoming and outgoing particles*. For the incoming lines, $-k$ are on-shell, for the outgoing lines, k is on-shell. The rules are changed only concerning the external lines:

- (i) To each incoming external line we associate $\frac{1}{\sqrt{(2\pi)^3 2\varepsilon(\vec{k})}}$.
- (ii) To each outgoing external line we associate $\frac{1}{\sqrt{(2\pi)^3 2\varepsilon(\vec{k})}}$.

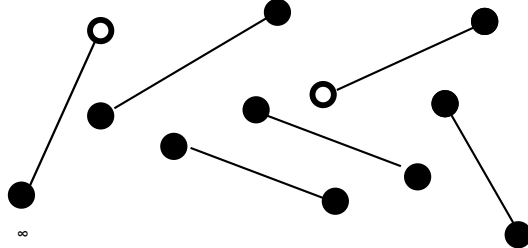

Figure 1: Diagram for Green's function.

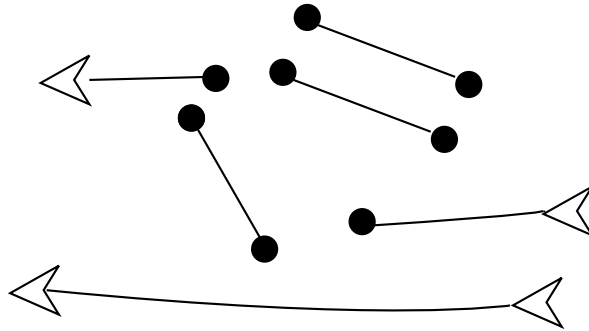

Figure 2: Diagram for a scattering amplitude.

2.2.9 Vacuum energy

Let D denote the value of the (unique) connected diagram with no external lines. We have

$$\log(\Omega|\hat{S}\Omega) = \frac{i}{2} \int \frac{|j(k)|^2}{(k^2 + m^2 - i0)} \frac{dk}{(2\pi)^4} = \frac{D}{2}.$$

We can derive it diagrammatically as follows. At the order $2m$ there are $\frac{(2m)!}{2^m m!}$ pairings. Hence

$$(\Omega|\hat{S}\Omega) = \sum_{m=0}^{\infty} \frac{1}{(2m)!} \frac{(2m)!}{2^m m!} D^m = \exp(D/2).$$

2.2.10 Problems with the scattering operator

\hat{S} can be ill defined.

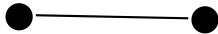

Figure 3: Diagram for vacuum energy.

First of all,

$$\operatorname{Re} \frac{1}{2} \int \frac{|j(k)|^2}{(k^2 + m^2 - i0)} \frac{dk}{(2\pi)^4} = \frac{1}{2} \int \frac{|j(k)|^2}{(k^2 + m^2)} \frac{dk}{(2\pi)^4} \quad (2.91)$$

can be infinite. This is not a very serious problem. (2.91) is responsible only for the phase of the scattering amplitude and does not influence scattering cross-sections.

We can try to remedy the problem by an appropriate renormalization of the phase. In particular, in the case of a stationary source or, more generally, a source travelling with a constant velocity, we can use the adiabatic switching and the Gell-Mann and Low construction to obtain a meaningful scattering operator. We will describe this construction in the next subsections.

The problem with \hat{S} is more serious if

$$\operatorname{Im} \frac{1}{2} \int \frac{|j(k)|^2}{(k^2 + m^2 - i0)} \frac{dk}{(2\pi)^4} = \frac{1}{2} \int \frac{|j(\varepsilon(\vec{k}), \vec{k})|^2}{\varepsilon(\vec{k})} \frac{d\vec{k}}{(2\pi)^3}$$

is infinite. Then no unitary operator \hat{S} satisfies the relations (2.80) and (2.81), see Thm A.1. The scattering operator is ill defined. However, as we describe in Subsubsect. 2.2.14, also in this situation there is a pragmatic solution – we can define *inclusive cross-sections*.

Note that if $k \mapsto j(k)$ is Schwartz, then \hat{S} is well-defined, even if $m = 0$.

2.2.11 Energy shift and scattering theory for a stationary source

Suppose now that the source does not depend on time and is given by a Schwartz function $\mathbb{R}^3 \ni \vec{x} \mapsto j(\vec{x})$. Then we have the time-independent Hamiltonian

$$\hat{H} = \int : \left(\frac{1}{2} \hat{\pi}(\vec{x})^2 + \frac{1}{2} (\vec{\partial} \hat{\phi}(\vec{x}))^2 + \frac{m^2}{2} \hat{\phi}(\vec{x})^2 + j(\vec{x}) \hat{\phi}(\vec{x}) \right) : d\vec{x}.$$

By the method of completing the square (A.14) we compute the infimum of \hat{H} :

$$E = -\frac{1}{2} \int j(\vec{x}) \frac{e^{-m|\vec{x}-\vec{y}|}}{4\pi|\vec{x}-\vec{y}|} j(\vec{y}) d\vec{x} d\vec{y}.$$

Obviously, the standard Møller operators \hat{S}^\pm (1.82) are ill defined and we need to use the Gell-Mann–Low construction. Let us replace j with $j_\varepsilon^\pm(t, \vec{x}) :=$

$\theta(\pm x)j(\vec{x})e^{-\epsilon|\vec{x}|}$. Its Fourier transform is $j_\epsilon^\pm(k^0, \vec{k}) = \mp i(k \mp i\epsilon)^{-1}j(\vec{k})$, Inserting this into (2.82) we obtain

$$\begin{aligned}\hat{S}_\epsilon^\pm &= \exp\left(-\int \frac{j(\vec{k})}{\sqrt{2\varepsilon(\vec{k})(\varepsilon(\vec{k}) \mp i\epsilon)}} a^*(k) \frac{d\vec{k}}{\sqrt{(2\pi)^3}}\right) \\ &\times \exp\left(\int \frac{\overline{j(\vec{k})}}{\sqrt{2\varepsilon(\vec{k})(\varepsilon(\vec{k}) \pm i\epsilon)}} a(k) \frac{d\vec{k}}{\sqrt{(2\pi)^3}}\right) \\ &\times \exp\left(-\frac{1}{2} \int \frac{|j(\vec{k})|^2}{2\varepsilon(\vec{k})(\varepsilon(\vec{k})^2 + \epsilon^2)} \frac{d\vec{k}}{(2\pi)^3} + \frac{i}{\epsilon 2} \int \frac{|j(\vec{k})|^2}{2(\varepsilon(\vec{k})^2 + \epsilon^2)} \frac{d\vec{k}}{(2\pi)^3}\right).\end{aligned}$$

Note that the phase of \hat{S}_ϵ^\pm behaves as $O(\epsilon^{-1})$. In the definition of S_{GL}^\pm we take this phase away and put $\epsilon \searrow 0$, see (1.83). We obtain

$$\begin{aligned}\hat{S}_{\text{GL}}^\pm &= \exp\left(-\int \frac{j(\vec{k})}{\sqrt{2\varepsilon(\vec{k})^3}} a^*(k) \frac{d\vec{k}}{\sqrt{(2\pi)^3}}\right) \\ &\times \exp\left(\int \frac{\overline{j(\vec{k})}}{\sqrt{2\varepsilon(\vec{k})^3}} a(k) \frac{d\vec{k}}{\sqrt{(2\pi)^3}}\right) \\ &\times \exp\left(-\frac{1}{2} \int \frac{|j(\vec{k})|^2}{2\varepsilon(\vec{k})^3} \frac{d\vec{k}}{(2\pi)^3}\right).\end{aligned}$$

If $m > 0$ or if $\int j(\vec{x})d\vec{x} = 0$, then \hat{H} has a ground state and the operators \hat{S}_{GL}^\pm are well defined. We have

$$\hat{S}_{\text{GL}}^\pm \hat{H}_{\text{fr}} = (\hat{H} - E)\hat{S}_{\text{GL}}^\pm.$$

Note a somewhat disappointing feature: $\hat{S}_{\text{GL}}^+ = \hat{S}_{\text{GL}}^-$, and hence the scattering operator $\hat{S}_{\text{GL}} := \hat{S}_{\text{GL}}^{+*}\hat{S}_{\text{GL}}^- = \mathbb{1}$ is trivial.

If $m = 0$ and $\int j(\vec{x})d\vec{x} \neq 0$, then \hat{H} has no ground state (even though it is bounded from below) and the operators \hat{S}_{GL}^\pm are ill defined.

2.2.12 Travelling source

Consider now a source of a profile given by a function $q \in C_c^\infty(\mathbb{R}^3)$ travelling with velocity \vec{v} . That means

$$j(t, \vec{x}) = q(\vec{x} - t\vec{v}). \quad (2.92)$$

We note that the Fourier transform of (2.92) in the spatial variables equals

$$j(t, \vec{k}) = q(\vec{k})e^{-it\vec{v}\vec{k}}.$$

The interaction picture Hamiltonian becomes

$$\hat{H}_{\epsilon, \text{Int}}(t) = \int \frac{d\vec{k}}{\sqrt{(2\pi)^3} \sqrt{2\varepsilon(\vec{k})}} \left(e^{-it(\varepsilon(\vec{k}) - \vec{v}\vec{k})} \overline{q(\vec{k})} \hat{a}(k) + e^{it(\varepsilon(\vec{k}) - \vec{v}\vec{k})} q(\vec{k}) \hat{a}^*(k) \right).$$

This is the interaction picture Hamiltonian for a time-independent perturbation where the 1-particle energy $\varepsilon(\vec{k})$ is replaced by $\varepsilon(\vec{k}) - \vec{v}\vec{k}$.

We use the Gell-Mann–Low type adiabatic switching, so that we replace j by

$$j_\epsilon(t, \vec{x}) := e^{-|t|\epsilon} j(t, \vec{x}).$$

We slightly generalize the Gell-Mann–Low Møller operators:

$$\begin{aligned} \hat{S}_{\text{GL}}^\pm &= \lim_{\epsilon \searrow 0} \frac{|\langle \Omega | \hat{S}_\epsilon^\pm | \Omega \rangle|}{|\langle \Omega | \hat{S}_\epsilon^\pm | \Omega \rangle|} \hat{S}_\epsilon^\pm \\ &= \exp \left(- \int \frac{q(\vec{k})}{\sqrt{2\varepsilon(\vec{k})(\varepsilon(\vec{k}) - \vec{v}\vec{k})}} a^*(k) \frac{d\vec{k}}{\sqrt{(2\pi)^3}} \right) \\ &\quad \times \exp \left(\int \frac{\overline{q(\vec{k})}}{\sqrt{2\varepsilon(\vec{k})(\varepsilon(\vec{k}) - \vec{v}\vec{k})}} a(k) \frac{d\vec{k}}{\sqrt{(2\pi)^3}} \right) \\ &\quad \times \exp \left(- \frac{1}{2} \int \frac{|q(\vec{k})|^2}{2\varepsilon(\vec{k})(\varepsilon(\vec{k}) - \vec{v}\vec{k})^2} \frac{d\vec{k}}{(2\pi)^3} \right). \end{aligned}$$

Note that if $|v| < 1$ (if the source is slower than light) and $m > 0$, then $\hat{S}_{\text{GL}}^+ = \hat{S}_{\text{GL}}^-$ are well defined unitary operators.

If $m = 0$ and $\int q(\vec{x}) d\vec{x} \neq 0$, then the infrared problem shows up: \hat{S}_{GL}^\pm are ill defined.

It is interesting to assume that the source has a different asymptotics in the future and in the past. For simplicity, suppose that the change occurs sharply at time $t = 0$ and consider

$$j(t, \vec{x}) = \begin{cases} q_-(\vec{x} - t\vec{v}_-), & t < 0, \\ q_+(\vec{x} - t\vec{v}_+), & t > 0. \end{cases}$$

The following operator can be used as a scattering operator:

$$\begin{aligned}
& \hat{S}_{\text{GL}}^{+*} \hat{S}_{\text{GL}}^- \tag{2.93} \\
= & \exp \left(\int \frac{1}{\sqrt{2\varepsilon(\vec{k})}} \left(\frac{q_+(\vec{k})}{(\varepsilon(\vec{k}) - \vec{v}_+\vec{k})} - \frac{q_-(\vec{k})}{(\varepsilon(\vec{k}) - \vec{v}_-\vec{k})} \right) \hat{a}^*(k) \frac{d\vec{k}}{\sqrt{(2\pi)^3}} \right) \\
& \times \exp \left(\int \frac{1}{\sqrt{2\varepsilon(\vec{k})}} \left(-\frac{\bar{q}_+(\vec{k})}{(\varepsilon(\vec{k}) - \vec{v}_+\vec{k})} + \frac{\bar{q}_-(\vec{k})}{(\varepsilon(\vec{k}) - \vec{v}_-\vec{k})} \right) \hat{a}(k) \frac{d\vec{k}}{\sqrt{(2\pi)^3}} \right) \\
& \times \exp \left(-\frac{1}{2} \int \frac{1}{2\varepsilon(\vec{k})} \left(\frac{|q_+(\vec{k})|^2}{(\varepsilon(\vec{k}) - \vec{v}_+\vec{k})^2} + \frac{|q_-(\vec{k})|^2}{(\varepsilon(\vec{k}) - \vec{v}_-\vec{k})^2} \right. \right. \\
& \quad \left. \left. - \frac{2q_+(\vec{k})q_-(\vec{k})}{(\varepsilon(\vec{k}) - \vec{v}_+\vec{k})(\varepsilon(\vec{k}) - \vec{v}_-\vec{k})} \right) \frac{d\vec{k}}{(2\pi)^3} \right).
\end{aligned}$$

Let $m = 0$. Then (2.93) is ill defined if

- (1) $\int q_+(\vec{x})d\vec{x} \neq \int q_-(\vec{x})d\vec{x}$,
- or
- (2) $\int q_+(\vec{x})d\vec{x} = \int q_-(\vec{x})d\vec{x} \neq 0$ and $v_+ \neq v_-$.

Alternatively, we can introduce first the scattering operator \hat{S}_ϵ with the adiabatically switched interaction. Then we can define another kind of scattering operator by taking $\epsilon \searrow 0$ and renormalizing the phase:

$$\begin{aligned}
& \lim_{\epsilon \searrow 0} \frac{|\langle \Omega | \hat{S}_\epsilon \Omega \rangle|}{|\langle \Omega | \hat{S}_\epsilon \Omega \rangle|} \hat{S}_\epsilon \tag{2.94} \\
= & \exp \left(\int \frac{1}{\sqrt{2\varepsilon(\vec{k})}} \left(\frac{q_+(\vec{k})}{(\varepsilon(\vec{k}) - \vec{v}_+\vec{k})} - \frac{q_-(\vec{k})}{(\varepsilon(\vec{k}) - \vec{v}_-\vec{k})} \right) \hat{a}^*(k) \frac{d\vec{k}}{\sqrt{(2\pi)^3}} \right) \\
& \times \exp \left(\int \frac{1}{\sqrt{2\varepsilon(\vec{k})}} \left(-\frac{\bar{q}_+(\vec{k})}{(\varepsilon(\vec{k}) - \vec{v}_+\vec{k})} + \frac{\bar{q}_-(\vec{k})}{(\varepsilon(\vec{k}) - \vec{v}_-\vec{k})} \right) \hat{a}(k) \frac{d\vec{k}}{\sqrt{(2\pi)^3}} \right) \\
& \times \exp \left(-\frac{1}{2} \int \frac{1}{2\varepsilon(\vec{k})} \left| \frac{q_+(\vec{k})}{(\varepsilon(\vec{k}) - \vec{v}_+\vec{k})} - \frac{q_-(\vec{k})}{(\varepsilon(\vec{k}) - \vec{v}_-\vec{k})} \right|^2 \frac{d\vec{k}}{(2\pi)^3} \right).
\end{aligned}$$

Note that (2.93) and (2.94) differ only by a phase. (2.94) is given by (2.82) where we replace

$$\int \frac{|j(k)|^2}{(k^2 + m^2 - i0)} \frac{dk}{(2\pi)^4}$$

with

$$\text{Im} \int \frac{|j(k)|^2}{(k^2 + m^2 - i0)} \frac{dk}{(2\pi)^4} = \int \frac{|j(\varepsilon(\vec{k}), \vec{k})|^2}{2\varepsilon(\vec{k})} \frac{d\vec{k}}{(2\pi)^3}.$$

Here, $j(k)$ is the Fourier transform of the source (2.92):

$$\begin{aligned} j(k) &= \int j(t, \vec{x}) e^{-i\vec{k}\vec{x} + ik^0 t} d\vec{x} dt \\ &= -\frac{i q_+(\vec{k})}{\vec{k}\vec{v}_+ - k^0 - i0} + \frac{i q_-(\vec{k})}{\vec{k}\vec{v}_- - k^0 + i0}. \end{aligned}$$

If we do not like the adiabatic switching approach we can directly define the Møller operators by removing the (possibly infinite) phase shift from (2.82).

2.2.13 Scattering cross-sections

We consider again an arbitrary source term j . Given on-shell momenta of incoming particles $k_{n^-}^-, \dots, k_1^-$ and outgoing particles $k_1^+, \dots, k_{n^+}^+$ we can compute the scattering cross-section for the corresponding process, or actually its density w.r.t. the Lebesgue measure $dk_1^+ \cdots dk_{n^+}^+$:

$$\begin{aligned} &\sigma(k_1^+, \dots, k_{n^+}^+; k_{n^-}^-, \dots, k_1^-) \\ &= \left| \left(k_1^+, \dots, k_{n^+}^+ \mid \hat{S} \mid k_{n^-}^-, \dots, k_1^- \right) \right|^2 \\ &= \frac{1}{\sqrt{(2\pi)^{(n^+ + n^-)}}} \exp\left(-\int \frac{|j(\varepsilon(\vec{k}), \vec{k})|^2 d\vec{k}}{2\varepsilon(\vec{k}) (2\pi)^3}\right) \\ &\quad \times \frac{|j(\varepsilon(\vec{k}_1^+), \vec{k}_1^+)|^2}{2\varepsilon(\vec{k}_1^+)} \cdots \frac{|j(\varepsilon(\vec{k}_{n^+}^+), \vec{k}_{n^+}^+)|^2}{2\varepsilon(\vec{k}_{n^+}^+)} \frac{|j(\varepsilon(\vec{k}_{n^-}^-), \vec{k}_{n^-}^-)|^2}{2\varepsilon(\vec{k}_{n^-}^-)} \cdots \frac{|j(\varepsilon(\vec{k}_1^-), \vec{k}_1^-)|^2}{2\varepsilon(\vec{k}_1^-)}. \end{aligned}$$

Note that the crosssections are zero if $m = 0$ and $\int j(x) dx \neq 0$. In the next subsection we describe how to cope with this problem.

2.2.14 Inclusive cross-section

Let $\delta > 0$. The 1-particle Hilbert space can be split as $\mathcal{Z} = \mathcal{Z}_{<\delta} \oplus \mathcal{Z}_{>\delta}$ corresponding to the *soft momenta* $|\vec{k}| < \delta$ and *hard momenta* $|\vec{k}| > \delta$. Clearly,

$$\Gamma_s(\mathcal{Z}) \simeq \Gamma(\mathcal{Z}_{<\delta}) \otimes \Gamma(\mathcal{Z}_{>\delta}), \quad \Omega \simeq \Omega_{<\delta} \otimes \Omega_{>\delta}.$$

Assume first that $m > 0$ and the scattering operator is computed as above. Clearly, the scattering operator and scattering cross-sections factorize:

$$\hat{S} \simeq \hat{S}_{<\delta} \otimes \hat{S}_{>\delta}, \quad \sigma = \sigma_{<\delta} \sigma_{>\delta}.$$

More precisely, let

$$|\vec{q}_1^+|, \dots, |\vec{q}_{m^+}^+|, |\vec{q}_1^-|, \dots, |\vec{q}_{m^-}^-| < \delta. \quad (2.95)$$

Then we have the *soft scattering cross-sections*

$$\begin{aligned}
& \sigma_{<\delta}(q_1^+, \dots, q_{m^+}^+; q_{m^-}^-, \dots, q_1^-) \\
&= \left| (q_1^+, \dots, q_{m^+}^+ | \hat{S}_{<\delta} | q_{m^-}^-, \dots, q_1^-) \right|^2 \\
&= \frac{1}{\sqrt{(2\pi)^{(m^++m^-)}}} \exp\left(-\int_{|\vec{q}|<\delta} \frac{|j(\varepsilon(\vec{q}), \vec{q})|^2}{2\varepsilon(\vec{q})} \frac{d\vec{q}}{(2\pi)^3}\right) \\
&\quad \times \frac{|j(\varepsilon(\vec{q}_1^+), \vec{q}_1^+)|^2}{2\varepsilon(\vec{q}_1^+)} \dots \frac{|j(\varepsilon(\vec{q}_{m^+}^+), \vec{q}_{m^+}^+)|^2}{2\varepsilon(\vec{q}_{m^+}^+)} \frac{|j(\varepsilon(\vec{q}_{m^-}^-), \vec{q}_{m^-}^-)|^2}{2\varepsilon(\vec{q}_{m^-}^-)} \dots \frac{|j(\varepsilon(\vec{q}_1^-), \vec{q}_1^-)|^2}{2\varepsilon(\vec{q}_1^-)}.
\end{aligned}$$

Likewise, let

$$|\vec{k}_1^+|, \dots, |\vec{k}_{n^+}^+|, |\vec{k}_1^-|, \dots, |\vec{k}_{n^-}^-| > \delta. \quad (2.96)$$

The corresponding *hard scattering cross-section* are

$$\begin{aligned}
& \sigma_{>\delta}(k_1^+, \dots, k_{n^+}^+; k_{n^-}^-, \dots, k_1^-) \\
&= \left| (k_1^+, \dots, k_{n^+}^+ | \hat{S}_{>\delta} | k_{n^-}^-, \dots, k_1^-) \right|^2 \\
&= \frac{1}{\sqrt{(2\pi)^{(n^++n^-)}}} \exp\left(-\int_{|\vec{k}|>\delta} \frac{|j(\varepsilon(\vec{k}), \vec{k})|^2}{2\varepsilon(\vec{k})} \frac{d\vec{k}}{(2\pi)^3}\right) \\
&\quad \times \frac{|j(\varepsilon(\vec{k}_1^+), \vec{k}_1^+)|^2}{2\varepsilon(\vec{k}_1^+)} \dots \frac{|j(\varepsilon(\vec{k}_{n^+}^+), \vec{k}_{n^+}^+)|^2}{2\varepsilon(\vec{k}_{n^+}^+)} \frac{|j(\varepsilon(\vec{k}_{n^-}^-), \vec{k}_{n^-}^-)|^2}{2\varepsilon(\vec{k}_{n^-}^-)} \dots \frac{|j(\varepsilon(\vec{k}_1^-), \vec{k}_1^-)|^2}{2\varepsilon(\vec{k}_1^-)}.
\end{aligned}$$

We have

$$\begin{aligned}
& \sigma_{>\delta}(k_1^+, \dots, k_{n^+}^+; k_{n^-}^-, \dots, k_1^-) \quad (2.97) \\
&= \sigma(k_1^+, \dots, k_{n^+}^+; k_{n^-}^-, \dots, k_1^-) \\
&\quad + \sum_{j=1}^{\infty} \int_{|\vec{q}_1|<\delta} \dots \int_{|\vec{q}_j|<\delta} \sigma(k_1^+, \dots, k_{n^+}^+, q_1, \dots, q_j; k_{n^-}^-, \dots, k_1^-) d\vec{q}_1 \dots d\vec{q}_j.
\end{aligned}$$

$\sigma_{>\delta}$ describes the experiment that does not measure outgoing particles of momentum less than δ and in the incoming state there are no particles of momentum less than δ . Actually, we would have obtained the same scattering cross-section if the part of the incoming state below the momentum δ was arbitrary. This is an example of an *inclusive cross-section* – a cross-section which involves summing over many unobserved final states.

If $m \searrow 0$, the *soft scattering operator* $\hat{S}_{<\delta}$ has no limit. All $\sigma_{<\delta}$ go to zero. In fact, they are proportional to

$$\sigma_{<\delta} = \exp\left(-\int_{|\vec{q}|<\delta} \frac{|j(\varepsilon(\vec{q}), \vec{q})|^2}{2\varepsilon(\vec{q})} \frac{d\vec{q}}{(2\pi)^3}\right).$$

The *hard scattering operator* $\hat{S}_{>\delta}$ and $\sigma_{>\delta}$ have well defined limits and can have a physical meaning.

One can imagine various experimental scenarios that lead to different inclusive cross-sections. For example, imagine that our apparatus does not detect the details of an outgoing state if the total energy of soft particles is less than δ . This leads to the following inclusive cross-section:

$$\begin{aligned} \sigma_{>\delta}^{\text{app}}(k_1^+, \dots, k_{n^+}^+; k_{n^-}^-, \dots, k_1^-) &:= \sigma(k_1^+, \dots, k_{n^+}^+; k_{n^-}^-, \dots, k_1^-) \\ &+ \sum_{j=1}^{\infty} \int_{\varepsilon(\vec{q}_1) + \dots + \varepsilon(\vec{q}_j) < \delta} \sigma(k_1^+, \dots, k_{n^+}^+, q_1, \dots, q_j; k_{n^-}^-, \dots, k_1^-) d\vec{q}_1 \cdots d\vec{q}_j. \end{aligned}$$

Note that both $\sigma_{>\delta}$ and $\sigma_{>\delta}^{\text{app}}$ are proportional to one another:

$$\begin{aligned} &\frac{\sigma_{>\delta}^{\text{app}}(k_1^+, \dots, k_{n^+}^+; k_{n^-}^-, \dots, k_1^-)}{\sigma_{>\delta}(k_1^+, \dots, k_{n^+}^+; k_{n^-}^-, \dots, k_1^-)} \\ &:= (\Omega_{<\delta} | \hat{S}_{<\delta}^* \mathbb{1}_{[0,\delta]}(\hat{H}_{\text{fr}}) \hat{S}_{<\delta} \Omega_{<\delta}) = \sigma_{<\delta}(\cdot) \\ &+ \sum_{j=1}^{\infty} \int_{\varepsilon(\vec{q}_1) + \dots + \varepsilon(\vec{q}_j) < \delta} \sigma_{<\delta}(q_1, \dots, q_j) d\vec{q}_1 \cdots d\vec{q}_j. \end{aligned} \tag{2.98}$$

This ratio is in practice not very interesting – it contributes a common numerical factor to all scattering cross-sections for hard particles.

2.3 Neutral scalar bosons with a mass-like perturbation

2.3.1 Classical fields

A scalar field can be also perturbed by a mass-like perturbation. Classically, this is expressed by the equation

$$(-\square + m^2)\phi(x) = -\kappa(x)\phi(x), \tag{2.99}$$

where $\mathbb{R}^{1,3} \ni x \mapsto \kappa(x)$ is a given function. In most of this subsection we will assume that κ is Schwartz and $m > 0$. We introduce also $\pi(x) := \dot{\phi}(x)$.

Let us define the corresponding retarded and advanced propagators as the unique distributional solutions of

$$(-\square_x + m^2 + \kappa(x))D^\pm(x, y) = \delta(x - y), \tag{2.100}$$

satisfying

$$\text{supp} D^\pm \subset \{x, y : x \in J^\pm(y)\}.$$

We also generalize the Pauli-Jordan function:

$$D(x, y) := D^+(x, y) - D^-(x, y).$$

Note that

$$\text{supp} D \subset \{x, y : x \in J(y)\}.$$

The function D can be used to solve the initial value problem of (2.99):

$$\begin{aligned}\phi(t, \vec{x}) &= - \int \partial_s D(t, \vec{x}, s, \vec{y}) \Big|_{s=0} \phi(0, \vec{y}) d\vec{y} \\ &\quad + \int D(t, \vec{x}, 0, \vec{y}) \pi(0, \vec{y}) d\vec{y}.\end{aligned}\tag{2.101}$$

We would like to interpret the classical field $\phi(x)$ satisfying (2.99) as a functional on the space \mathcal{Y}_{KG} coinciding with the free field at time 0, as in (2.64). By (2.101), this allows us to express uniquely the field ϕ in terms of the free field.

2.3.2 Lagrangian and Hamiltonian formalism

The Lagrangian density is

$$\mathcal{L}(x) = -\frac{1}{2} \partial_\mu \phi(x) \partial^\mu \phi(x) - \frac{1}{2} (m^2 + \kappa(x)) \phi(x)^2.$$

As in Subsect. 2.2.2, the variable conjugate to $\phi(x)$ is $\pi(x)$. We easily obtain the Hamiltonian density

$$\mathcal{H}(x) = \frac{1}{2} \pi^2(x) + \frac{1}{2} (\vec{\partial} \phi(x))^2 + \frac{1}{2} (m^2 + \kappa(x)) \phi^2(x),$$

so that the full Hamiltonian generating the dynamics is

$$H(t) = \int \mathcal{H}(t, \vec{x}) d\vec{x}.$$

2.3.3 Dynamics in the interaction picture

The classical interaction picture Hamiltonian can be expressed in terms of plane wave functionals:

$$\begin{aligned}H_{\text{Int}}(t) &= \frac{1}{2} \int \kappa(t, \vec{x}) \phi_{\text{fr}}^2(t, \vec{x}) d\vec{x} \\ &= \frac{1}{2} \int \frac{d\vec{k}_1 d\vec{k}_2 \kappa(t, \vec{k}_1 + \vec{k}_2)}{(2\pi)^3 \sqrt{2\varepsilon(\vec{k}_1)} \sqrt{2\varepsilon(\vec{k}_2)}} \left(e^{-it\varepsilon(\vec{k}_1) - it\varepsilon(\vec{k}_2)} a(-k_1) a(-k_2) \right. \\ &\quad \left. + 2e^{it\varepsilon(\vec{k}_1) - it\varepsilon(\vec{k}_2)} a^*(k_1) a(-k_2) + e^{it\varepsilon(\vec{k}_1) + it\varepsilon(\vec{k}_2)} a^*(k_1) a^*(k_2) \right).\end{aligned}\tag{2.102}$$

Consider the equations of motion in the interaction picture:

$$\begin{aligned}\dot{a}_t^*(k) &= \{a_t^*(k), H_{\text{Int}}(t)\} \\ &= i \int \frac{d\vec{k}_1 \kappa(t, -\vec{k} + \vec{k}_1)}{(2\pi)^3 \sqrt{2\varepsilon(\vec{k})} \sqrt{2\varepsilon(\vec{k}_1)}} \\ &\quad \times \left(e^{-it\varepsilon(\vec{k}) - it\varepsilon(\vec{k}_1)} a_t(-k_1) + e^{-it\varepsilon(\vec{k}) + it\varepsilon(\vec{k}_1)} a_t^*(k_1) \right), \\ a_0^*(k) &= a^*(k).\end{aligned}$$

The solution of these equations at two times are related by a matrix of the form

$$\begin{bmatrix} p_{t_+,t_-} & q_{t_+,t_-} \\ \overline{q_{t_+,t_-}} & \overline{p_{t_+,t_-}} \end{bmatrix} \quad (2.103)$$

in the following way:

$$\begin{bmatrix} a_{t_+}^*(k) \\ a_{t_+}(k) \end{bmatrix} = \int d\vec{k}_1 \begin{bmatrix} p_{t_+,t_-}(k, k_1) & q_{t_+,t_-}(k, k_1) \\ \overline{q_{t_+,t_-}(k, k_1)} & \overline{p_{t_+,t_-}(k, k_1)} \end{bmatrix} \begin{bmatrix} a_{t_-}^*(k_1) \\ a_{t_-}(k_1) \end{bmatrix}.$$

(2.103) has a limit as $t_+, -t_- \rightarrow \infty$, which can be called the *classical scattering operator*.

One can try to solve the equations of motion by iterations. The first iteration is often (at least in the quantum context) called the *Born approximation*, and it gives the following formula for the elements of (2.103):

$$\begin{aligned} p_{t_+,t_-}^{\text{Born}}(k, k_1) &= \delta(\vec{k} - \vec{k}_1) + i \int_{t_-}^{t_+} ds \frac{\kappa(s, -\vec{k} + \vec{k}_1)}{(2\pi)^3 \sqrt{2\varepsilon(\vec{k})} \sqrt{2\varepsilon(\vec{k}_1)}} e^{-is\varepsilon(\vec{k}) + is\varepsilon(\vec{k}_1)}, \\ q_{t_+,t_-}^{\text{Born}}(k, k_1) &= i \int_{t_-}^{t_+} ds \frac{\kappa(s, -\vec{k} + \vec{k}_1)}{(2\pi)^3 \sqrt{2\varepsilon(\vec{k})} \sqrt{2\varepsilon(\vec{k}_1)}} e^{-is\varepsilon(\vec{k}) - is\varepsilon(\vec{k}_1)}. \end{aligned}$$

2.3.4 Quantization

Again, we are looking for quantum fields $\mathbb{R}^{1,3} \mapsto \hat{\phi}(x)$ satisfying

$$(-\square + m^2)\hat{\phi}(x) = -\kappa(x)\hat{\phi}(x), \quad (2.104)$$

with the conjugate field $\hat{\pi}(x) := \dot{\hat{\phi}}(x)$ having the equal time commutators (2.72), and coinciding with the free field at time 0, as in (2.73). The solution is given by putting “hats” onto (2.101).

We would like to check whether the classical scattering operator and the classical dynamics are implementable in the Fock space for nonzero κ . By Thm A.2, we need to check the *Shale condition*, that is, whether the off-diagonal elements of (2.103) are square integrable. For simplicity, we will restrict ourselves to the Born approximation; the higher order terms do not change the conclusion.

The verification of the Shale condition is easier for the scattering operator. Consider

$$q_{\infty,-\infty}^{\text{Born}}(k, k_1) = i \int_{-\infty}^{\infty} ds \frac{\kappa(s, -\vec{k} + \vec{k}_1)}{(2\pi)^3 \sqrt{2\varepsilon(\vec{k})} \sqrt{2\varepsilon(\vec{k}_1)}} e^{-is\varepsilon(\vec{k}) - is\varepsilon(\vec{k}_1)}. \quad (2.105)$$

Recall that κ is a Schwartz function. Therefore, we can integrate by parts as many times as we want:

$$q_{\infty,-\infty}^{\text{Born}}(k, k_1) = i^{n+1} \int_{-\infty}^{\infty} ds \frac{\partial_s^n \kappa(s, -\vec{k} + \vec{k}_1)}{(2\pi)^3 \sqrt{2\varepsilon(\vec{k})} \sqrt{2\varepsilon(\vec{k}_1)}} \frac{e^{-is\varepsilon(\vec{k}) - is\varepsilon(\vec{k}_1)}}{(\varepsilon(\vec{k}) + \varepsilon(\vec{k}_1))^n}. \quad (2.106)$$

This decays in \vec{k} and \vec{k}_1 as any inverse power, and hence is square integrable on $\mathbb{R}^3 \times \mathbb{R}^3$. Therefore the classical scattering operator is implementable.

Next let us check the implementability of the dynamics, believing again that it is sufficient to check the Born approximation. We integrate by parts once:

$$\begin{aligned}
& q_{t_+, t_-}^{\text{Born}}(k, k_1) \\
= & \frac{-\kappa(t_+, -\vec{k} + \vec{k}_1)e^{-it_+\varepsilon(\vec{k})-it_+\varepsilon(\vec{k}_1)} + \kappa(t_-, -\vec{k} + \vec{k}_1)e^{-it_-\varepsilon(\vec{k})-it_-\varepsilon(\vec{k}_1)}}{(2\pi)^3 \sqrt{2\varepsilon(\vec{k})} \sqrt{2\varepsilon(\vec{k}_1)} (\varepsilon(\vec{k}) + \varepsilon(\vec{k}_1))} \\
& + \int_{t_-}^{t_+} ds \frac{\partial_s \kappa(s, -\vec{k} + \vec{k}_1)e^{-is\varepsilon(\vec{k})-is\varepsilon(\vec{k}_1)}}{(2\pi)^3 \sqrt{2\varepsilon(\vec{k})} \sqrt{2\varepsilon(\vec{k}_1)} (\varepsilon(\vec{k}) + \varepsilon(\vec{k}_1))}. \tag{2.107}
\end{aligned}$$

Using that $\kappa(s, \vec{k} + \vec{k}_1)$ decays fast in the second variable, we see that (2.107) can be estimated by

$$\frac{C}{(\varepsilon(\vec{k}) + \varepsilon(\vec{k}_1))^2},$$

which is square integrable. Therefore, the dynamics is implementable for any t_-, t_+ .

By a similar computation we check that if we freeze $t_0 \in \mathbb{R}$, the dynamics generated by the momentary Hamiltonian $H_{\text{Int}}(t_0)$ is implementable.

2.3.5 Quantum Hamiltonian

We may try to write the quantum Hamiltonian as

$$\hat{H}(t) := \int : \left(\frac{1}{2} \hat{\pi}^2(\vec{x}) + \frac{1}{2} (\vec{\partial} \hat{\phi}(\vec{x}))^2 + \frac{1}{2} (m^2 + \kappa(t, \vec{x})) \hat{\phi}^2(x) \right) : d\vec{x}. \tag{2.108}$$

We will see later on that the Wick-ordered expression (2.108) does not define an operator. However we will use it to derive the Feynman rules, which unfortunately will lead to divergent diagrams.

Formally (2.75) remains true if we add a time dependent constant $C(t)$ to (2.108). We will see that in order to define correct Hamiltonians $\hat{H}(t)$ this constant has to be infinite. We will obtain bounded from below Hamiltonians $\hat{H}_{\text{ren}}(t)$, however the vacuum will not be contained in their form domain. Therefore, the condition $(\Omega | \hat{H}_{\text{ren}}(t) \Omega) = 0$ for all t , which is equivalent to the Wick ordering, cannot be imposed.

The interaction picture Hamiltonian is

$$\begin{aligned}
\hat{H}_{\text{Int}}(t) &= \frac{1}{2} \int \kappa(t, \vec{x}) : \hat{\phi}_{\text{fr}}^2(t, \vec{x}) : d\vec{x} \\
&= \frac{1}{2} \int \frac{d\vec{k}_1 d\vec{k}_2 \kappa(t, \vec{k}_1 + \vec{k}_2)}{(2\pi)^3 \sqrt{2\varepsilon(\vec{k}_1)} \sqrt{2\varepsilon(\vec{k}_2)}} \left(e^{-it\varepsilon(\vec{k}_1) - it\varepsilon(\vec{k}_2)} \hat{a}(-k_1) \hat{a}(-k_2) \right. \\
&\quad \left. + 2e^{it\varepsilon(\vec{k}_1) - it\varepsilon(\vec{k}_2)} \hat{a}^*(k_1) \hat{a}(-k_2) + e^{it\varepsilon(\vec{k}_1) + it\varepsilon(\vec{k}_2)} \hat{a}^*(k_1) \hat{a}^*(k_2) \right). \tag{2.109}
\end{aligned}$$

As in the case of linear sources, we define the scattering operator, scattering amplitudes, Green's functions, amputated Green's functions and the generating function, see (2.83)–(2.88).

2.3.6 Path integral formulation

The generating function (and hence all the other quantities introduced above) can be computed exactly. It is

$$\begin{aligned}
Z(f) &= \left(\det \left((-\square + m^2)(-\square + m^2 + \kappa - i0)^{-1} \exp \left(\kappa \frac{1}{-\square + m^2 - i0} \right) \right) \right)^{\frac{1}{2}} \\
&\quad \times \exp \left(\frac{i}{2} f(-\square + m^2 + \kappa - i0)^{-1} f \right) \\
&= \left(\det(\mathbb{1} + \kappa D_{\text{fr}}^c)^{-1} \exp(\kappa D_{\text{fr}}^c) \right)^{\frac{1}{2}} \\
&\quad \times \exp \left(\frac{i}{2} f D_{\text{fr}}^c (\mathbb{1} + \kappa D_{\text{fr}}^c)^{-1} f \right). \tag{2.110}
\end{aligned}$$

Here, the determinant is understood (at least formally) as the Fredholm determinant on the space $L^2(\mathbb{R}^{1,3})$. The term $\exp(\kappa D_{\text{fr}}^c)^{\frac{1}{2}}$ is responsible for the Wick ordering.

Similarly as in the case of (2.90), (2.110) is often expressed in terms of path integrals as

$$C \int_{\Pi} d\phi(x) \exp \left(i \int (\mathcal{L}(x) - f(x)\phi(x)) dx \right). \tag{2.111}$$

Here, C is a normalization constant, which does not depend on f . Again, the formula (2.111) is only symbolic, the full information is contained in (2.110).

2.3.7 Feynman rules

Feynman rules are similar as in the case of a linear source. The difference is that now vertices have 2-legs. The rule (2) for calculating Green's functions changes: for each vertex with incoming momenta k_1, k_2 we insert the number $-i\kappa(k_1 + k_2)$, where k_1 and k_2 are the momenta of lines entering the vertex. Another difference is that we do not allow a line to begin and end at the same vertex – this is because we use the Wick ordered $\hat{H}(t)$.

Diagrams can be decomposed into connected components of two kinds:

1. lines ending at insertion vertices (for Green's functions) or on-shell particles (for scattering amplitudes) with $0, 1, 2, \dots$ interaction vertices;
2. loops with $2, 3, \dots$ interaction vertices.

Note that loops with 1 interaction vertex do not appear because of the Wick ordering.

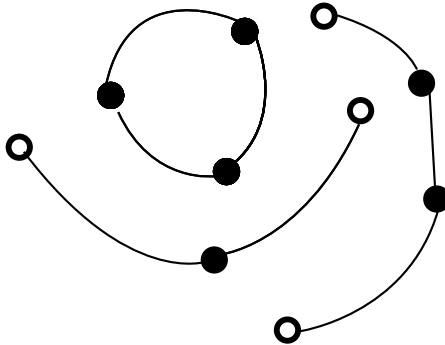

Figure 4: Diagram for Green's function.

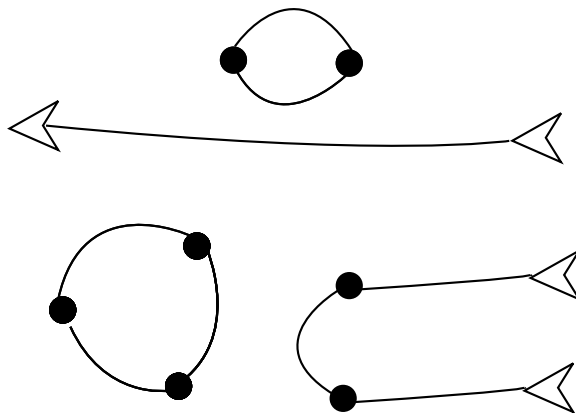

Figure 5: Diagram for scattering amplitude.

Diagrams without loops (both for Green's functions and scattering amplitudes) are finite, because the external momenta are fixed and on interaction vertices we have the fast decaying function κ .

Consider a loop with 4-momenta k_1, \dots, k_n flowing around it. On vertices we have the function κ , which essentially identifies k_i with k_{i+1} . The propagators give the power $|k_i|^{-2}$. Thus we are left with 4 degrees of freedom and the integrand that behaves as $|k|^{-2n}$. This is integrable if $n > 2$, but divergent for the 2-vertex loop. We will see that only the imaginary part of this diagram is divergent.

2.3.8 Vacuum energy

The classical scattering operator is well defined. The quantum scattering operator, if computed naively (that is, using the Wick ordered Hamiltonian) is ill defined. Its problem comes from the overall phase, which is not fixed by the classical transformation.

One can say that this phase has no physical meaning, since it does not appear in scattering cross-sections. However, it may be relevant for a more complete theory. We will see that there is a natural choice of this phase, which leads to a renormalized scattering operator $\hat{S}_{\text{ren}}(\kappa)$. We will also see that there is a natural renormalized Hamiltonian $\hat{H}_{\text{ren}}(t)$.

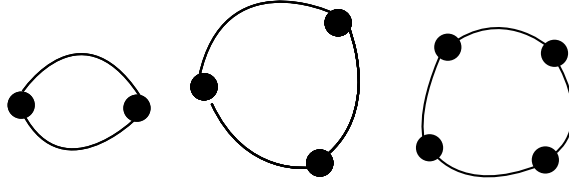

Figure 6: Vacuum energy

The logarithm of the *vacuum-to-vacuum scattering amplitude* times the imaginary unit will be called the *vacuum energy*. It can be computed exactly:

$$\begin{aligned}
 \mathcal{E} &:= i \log(\Omega | \hat{S} \Omega) = i \log Z(0) \\
 &= \frac{i}{2} \text{Tr} \left(\log(-\square + m^2 - i0) - \log(-\square + m^2 + \kappa - i0) + \kappa(-\square + m^2 - i0)^{-1} \right) \\
 &= \frac{i}{2} \text{Tr} \left(-\log(1 + \kappa D_{\text{fr}}^c) + \kappa D_{\text{fr}}^c \right) \\
 &= i \sum_{n=2}^{\infty} \frac{(-1)^n}{2n} \text{Tr}(\kappa D_{\text{fr}}^c)^n =: \sum_{n=2}^{\infty} \mathcal{E}_n.
 \end{aligned} \tag{2.112}$$

Here, Tr is understood (at least formally) as the usual trace of operators on $L^2(\mathbb{R}^{1,3})$. \mathcal{E}_n is the n th order contribution to the vacuum energy. Note that for $n = 1$ there is no contribution because of the Wick ordering and for $n = 2$ it is divergent.

We have $\mathcal{E}_n = i \frac{D_n}{2n}$, where $D_n = (-1)^n \text{Tr}(\kappa D_{\text{fr}}^c)^n$ is the value of the loop with n vertices. This is a special case of a more general rule saying that to compute $\log(\Omega | \hat{S} \Omega)$ we need to sum over all connected diagrams with no external lines divided by the symmetry factor (the order of the group of the symmetries of the diagram). In the case of a loop with n vertices its group of symmetries is the n th dihedral group, hence the symmetry factor is $2n$.

2.3.9 Pauli-Villars renormalization

The lowest contribution to the vacuum energy is of the second order and comes from the loop with two vertices. Formally, it can be written as

$$\mathcal{E}_2 = \int \kappa(-k)\kappa(k)\pi(k)\frac{dk}{(2\pi)^4} = \int |\kappa(k)|^2\pi(k)\frac{dk}{(2\pi)^4},$$

where the right hand side defines the *vacuum energy function* $\pi(k)$. Unfortunately, computed naively, $\pi(k)$ is logarithmically divergent.

The renormalization of a mass-like perturbation is not very difficult and can be done in many ways. We will describe 3 methods of renormalization. All of them will lead to the same *renormalized vacuum energy function* $\pi^{\text{ren}}(k)$.

We start with the *Pauli-Villars method*. In the context of a mass-like perturbation, the Pauli-Villars regularization consists in introducing an additional fictitious field that has a (large) mass M and appears only in loops. (Thus we ignore diagrams involving external lines of the fictitious particle). In addition, each loop of the fictitious field has a (nonphysical) coefficient -1 . We organize our computations by setting $m_0 = m$, $C_0 = 1$, $m_1 = M$, and $C_1 = -1$. The *Pauli-Villars regularized vacuum energy function* is the sum of the loop of the physical particle and of the fictitious one:

$$\begin{aligned} 4\pi_M(k^2) &= i \int \frac{d^4q}{(2\pi)^4} \sum_i C_i \frac{1}{((q + \frac{1}{2}k)^2 + m_i^2 - i0)((q - \frac{1}{2}k)^2 + m_i^2 - i0)} \\ &= -i \int \frac{d^4q}{(2\pi)^4} \int_0^\infty d\alpha_1 \int_0^\infty d\alpha_2 \sum_i C_i \exp\left(-i(\alpha_1 + \alpha_2)\left(q^2 + \frac{1}{4}k^2 + m_i^2\right) - i(\alpha_1 - \alpha_2)qk\right) \\ &= -\frac{1}{(4\pi)^2} \int_0^\infty d\alpha_1 \int_0^\infty d\alpha_2 \sum_i C_i \frac{1}{(\alpha_1 + \alpha_2)^2} \exp\left(-i(\alpha_1 + \alpha_2)m_i^2 - i\frac{\alpha_1\alpha_2}{\alpha_1 + \alpha_2}k^2\right) \\ &= -\frac{1}{(4\pi)^2} \int_0^1 dv \int_0^\infty \frac{d\rho}{\rho} \sum_i C_i \exp\left(-i\rho\left(m_i^2 + \frac{(1-v^2)k^2}{4}\right)\right) \\ &= \frac{1}{(4\pi)^2} \int_0^1 dv \sum_i C_i \log\left(m_i^2 + \frac{k^2(1-v^2)}{4} - i0\right) \\ &= \frac{1}{(4\pi)^2} \int_0^1 dv \sum_i C_i \left(\log\left(1 + \frac{(1-v^2)k^2}{4m_i^2} - i0\right) + \log m_i^2\right). \end{aligned}$$

We used the identities (A.20) and (A.22). We inserted

$$1 = \int_0^\infty d\rho \delta(\rho - \alpha_1 - \alpha_2), \quad (2.113)$$

and then changed the variables as $\alpha_1 = \rho\frac{(1-v)}{2}$, $\alpha_2 = \rho\frac{(1+v)}{2}$, so that $d\alpha_1 d\alpha_2 = \frac{1}{2}\rho dv d\rho$. We also used the symmetry $v \mapsto -v$ to restrict the integration from $[-1, 1]$ to $[0, 1]$. At the end we use the identity (A.24).

We define the *renormalized vacuum energy function* as

$$\begin{aligned}
\pi^{\text{ren}}(k^2) &:= \lim_{M \rightarrow \infty} (\pi_M(k^2) - \pi_M(0)) \\
&= \lim_{M \rightarrow \infty} \left(\pi_M(k^2) + \frac{1}{4(4\pi)^2} \log \frac{M^2}{m^2} \right) \\
&= \frac{1}{4(4\pi)^2} \int_0^1 \log \left(1 + \frac{k^2(1-v^2)}{4m^2} - i0 \right) dv. \quad (2.114)
\end{aligned}$$

Note that $\pi^{\text{ren}}(0) = 0$. Using (A.26) we obtain

$$\begin{aligned}
&\pi^{\text{ren}}(k^2) \\
&= \frac{1}{4(4\pi)^2} \left(\frac{\sqrt{k^2 + 4m^2}}{\sqrt{k^2}} \log \frac{\sqrt{k^2 + 4m^2} + \sqrt{k^2}}{\sqrt{k^2 + 4m^2} - \sqrt{k^2}} - 2 \right), \quad 0 < k^2.
\end{aligned}$$

Using the analyticity and $\log \frac{x+iy}{x-iy} = 2i \arctan \frac{y}{x}$ we can extend this formula for $k^2 < 0$:

$$\begin{aligned}
&\pi^{\text{ren}}(k^2) \\
&= \frac{1}{4(4\pi)^2} \left(\frac{\sqrt{k^2 + 4m^2}}{\sqrt{-k^2}} 2 \arctan \frac{\sqrt{-k^2}}{\sqrt{k^2 + 4m^2}} - 2 \right), \quad -4m^2 < k^2 < 0; \\
&= \frac{1}{4(4\pi)^2} \left(\frac{\sqrt{-k^2 - 4m^2}}{\sqrt{-k^2}} \left(\log \frac{\sqrt{-k^2 - 4m^2} + \sqrt{-k^2}}{\sqrt{-k^2 - 4m^2} - \sqrt{-k^2}} - i\pi \right) - 2 \right), \quad k^2 < -4m^2.
\end{aligned}$$

2.3.10 Renormalization of the vacuum energy

The renormalized 2nd order vacuum energy is

$$\begin{aligned}
\mathcal{E}_2^{\text{ren}} &= \int \pi^{\text{ren}}(k) |\kappa(k)|^2 \frac{dk}{(2\pi)^4} \\
&= \lim_{M \rightarrow \infty} \int (\pi_M(k) - \pi_M(0)) |\kappa(k)|^2 \frac{dk}{(2\pi)^4} \\
&= \lim_{M \rightarrow \infty} \left(\frac{1}{(2\pi)^4} \int \pi_M(k) |\kappa(k)|^2 \frac{dk}{(2\pi)^4} - \pi_M(0) \int \kappa(x)^2 dx \right).
\end{aligned}$$

The full renormalized vacuum energy has a compact formula:

$$\begin{aligned}
\mathcal{E}^{\text{ren}} &= \mathcal{E}_2^{\text{ren}} + \sum_{n=3}^{\infty} \mathcal{E}_n \\
&= -\frac{i}{2} \text{Tr} \left(\log(1 + \kappa D_{\text{fr}}^c) - \kappa D_{\text{fr}}^c + \frac{(\kappa D_{\text{fr}}^c)^2}{2} \right) \\
&\quad + \int |\kappa(k)|^2 \pi^{\text{ren}}(k) \frac{dk}{(2\pi)^4}. \quad (2.115)
\end{aligned}$$

We can formally write $\pi_\infty(k) := \lim_{M \rightarrow \infty} \pi_M(k)$ (which is typically infinite). Note that the renormalized scattering operator \hat{S}_{ren} is a well defined unitary operator and the renormalized Hamiltonian $\hat{H}_{\text{ren}}(t)$ is a well defined self-adjoint operator:

$$\hat{S}_{\text{ren}} = e^{i\pi_\infty(0) \int \kappa(x)^2 dx} \hat{S}, \quad (2.116)$$

$$\hat{H}_{\text{ren}}(t) = \hat{H}(t) - \pi_\infty(0) \int \kappa(t, \vec{x})^2 d\vec{x}. \quad (2.117)$$

The counterterm has an infinite coefficient $\pi_\infty(0)$. Otherwise, it is quite well behaved – it depends locally on the interaction, and therefore the renormalization preserves the Einstein causality. This manifests itself in the identity

$$\hat{S}_{\text{ren}}(\kappa_2) \hat{S}_{\text{ren}}(\kappa_1) = \hat{S}_{\text{ren}}(\kappa_2 + \kappa_1),$$

whenever $\text{supp} \kappa_2$ is later than $\text{supp} \kappa_1$.

Formally, the correct Lagrangian density is

$$\mathcal{L}_{\text{ren}}(x) = \mathcal{L}(x) + \pi_\infty(0) \kappa(x)^2.$$

2.3.11 Method of dispersion relations

There exists an alternative method to renormalize and compute the vacuum energy. We start with computing the imaginary part of $\pi(k)$ without a regularization, which gives a finite result:

$$\begin{aligned} \text{Im} \pi^{\text{ren}}(k^2) &= \text{Im} \frac{i}{4} \int \frac{d^4 q}{(2\pi)^4} \frac{1}{((q + \frac{1}{2}k)^2 + m^2 - i0)((q - \frac{1}{2}k)^2 + m^2 - i0)} \\ &= \text{Im} \frac{1}{4(4\pi)^2} \int_0^1 dv \left(\log \left(1 + \frac{(1-v^2)k^2}{4m^2} - i0 \right) + \log m^2 \right). \end{aligned}$$

Using $\log(t - i0) = \log|t| - i\pi\theta(-t)$, we see that the imaginary part of the logarithm is very simple. Hence

$$\begin{aligned} \text{Im} \pi^{\text{ren}}(k^2) &= -\frac{\pi}{4(4\pi)^2} \int_0^1 \theta \left(-1 - \frac{(1-v^2)k^2}{4m^2} \right) dv \\ &= -\frac{\pi}{4(4\pi)^2 \sqrt{-k^2}} \sqrt{\left| -k^2 - 4m^2 \right|_+}. \end{aligned}$$

We can obtain the real part by using the fact that $\pi^{\text{ren}}(0) = 0$ and the once subtracted dispersion relations for the lower complex halfplane, see Thm A.4:

$$\text{Re} \pi^{\text{ren}}(k^2) = -\frac{1}{\pi} \mathcal{P} \int_{-\infty}^{-4m^2} ds \text{Im} \pi^{\text{ren}}(s) \left(\frac{1}{s - k^2} - \frac{1}{s} \right). \quad (2.118)$$

2.3.12 Wick rotation

Recall that the causal propagator is defined as

$$\mathbb{R}^{1,3} \ni p \mapsto D^c(p) = \frac{1}{p^2 + m^2 - i0}.$$

It can be interpreted as a boundary value of a holomorphic function

$$\begin{aligned} \left(\mathbb{C} \setminus (]-\infty, -m] \cup [m, \infty[) \right) \times \mathbb{R}^3 &\ni (p^0, \vec{p}) \\ \mapsto D^c(p) &= \frac{1}{-(p^0)^2 + \vec{p}^2 + m^2} = \frac{1}{p^2 + m^2}. \end{aligned} \quad (2.119)$$

The *physical region* $\mathbb{R}^{1,3}$ of (2.119) lies at the boundary—on $]0, \infty[\times \mathbb{R}^3$ from above and on $] - \infty, 0[\times \mathbb{R}^3$ from below:

$$D^c(p) = \lim_{\phi \searrow 0} D^c(e^{i\phi} p^0, \vec{p}).$$

Define the *Euclidean scalar product* as

$$\langle p|q \rangle_E := p^0 q^0 + \vec{p}\vec{q},$$

and the *Euclidean propagator*

$$\begin{aligned} \left(\mathbb{C} \setminus (]-i\infty, -im] \cup [im, i\infty[) \right) \times \mathbb{R}^3 &\ni (p^0, \vec{p}) \\ \mapsto D^E(p^0, \vec{p}) := D(ip^0, \vec{p}) &= \frac{1}{(p^0)^2 + \vec{p}^2 + m^2} = \frac{1}{\langle p|p \rangle_E^2 + m^2}. \end{aligned} \quad (2.120)$$

Clearly, we can express the causal propagator in terms of the Euclidean propagator with help of the *Wick rotation*:

$$D^c(p^0, \vec{p}) = \lim_{\phi \nearrow \pi/2} D^E(e^{-i\phi} p^0, \vec{p}).$$

Suppose now that a physical quantity is given by an integral

$$\mathbb{R}^{1,3} \ni p \mapsto F(p) := \int \frac{d^4 q}{(2\pi)^4} \frac{G(p^2, pq, q^2)}{(ap^2 + 2bpq + cq^2 + m^2 - i0)^n}, \quad (2.121)$$

where G is holomorphic and the matrix $\begin{bmatrix} a & b \\ b & c \end{bmatrix}$ is positive definite. Then instead of F we can consider the holomorphic function

$$\begin{aligned} \left(\mathbb{C} \setminus (]-\infty, -m] \cup [m, \infty[) \right) \times \mathbb{R}^3 &\ni (p^0, \vec{p}) \\ \mapsto F(p) &:= \int \frac{d^4 q}{(2\pi)^4} \frac{G(p^2, pq, q^2)}{(ap^2 + 2bpq + cq^2 + m^2)^n}, \end{aligned} \quad (2.122)$$

where there is no need to put $i0$, because the denominator is automatically invertible. The physical function (2.121) is the boundary value of (2.122):

$$\lim_{\phi \searrow 0} F(e^{i\phi} p^0, \vec{p}).$$

We can also introduce the Euclidean version of F given by

$$\begin{aligned} F^{\text{E}}(p) &= F^{\text{E}}(p^0, \vec{p}) := F(ip^0, \vec{p}) \\ &= \int \frac{d^4 q}{(2\pi)^4} \frac{G(\langle p|p\rangle_{\text{E}}^2, \langle p|q\rangle_{\text{E}}, \langle q|q\rangle_{\text{E}}^2)}{(a\langle p|p\rangle_{\text{E}}^2 + 2b\langle p|q\rangle_{\text{E}} + c\langle q|q\rangle_{\text{E}}^2 + m^2)^n}, \end{aligned}$$

where in the integral we substituted (iq^0, \vec{q}) for (q^0, \vec{q}) . This substitution can be reached from the original variables inside the holomorphy domain by the Wick rotation, hence it does not affect the integral. F^{E} is holomorphic on the domain of (2.120). We can retrieve the physical values of F from F^{E} by

$$F(p^0, \vec{p}) = \lim_{\phi \nearrow \pi/2} F^{\text{E}}(e^{-i\phi} p^0, \vec{p}).$$

In what follows, whenever we use Euclidean functions such as F^{E} , we will use the Euclidean scalar product $\langle p|q\rangle_{\text{E}}$. We will denote this scalar product simply by pq , since its use will be obvious from the context.

2.3.13 Dimensional renormalization

Let us renormalize the vacuum energy by yet another method – the method of dimensional regularization. We will use the Euclidean quantities.

Let us first compute formally the 2-vertex loop:

$$\begin{aligned} 4\pi^{\text{E}}(k^2) &= - \int \frac{d^4 q}{(2\pi)^4} \frac{1}{((q + \frac{1}{2}k)^2 + m^2)((q - \frac{1}{2}k)^2 + m^2)} \\ &= - \frac{1}{2} \int_{-1}^1 dv \int \frac{d^4 q}{(2\pi)^4} \frac{1}{(q^2 + \frac{k^2}{4} + m^2 + vqk)^2} \\ &= - \int_0^1 dv \int \frac{d^4 q}{(2\pi)^4} \frac{1}{(q^2 + \frac{k^2}{4}(1-v^2) + m^2)^2}, \end{aligned} \quad (2.123)$$

where we used the Feynman identity (A.28), replaced $q + \frac{vp}{2}$ with q , used the symmetry $v \rightarrow -v$ to replace $\frac{1}{2} \int_{-1}^1 dv$ with $\int_0^1 dv$. After this preparation, we use the dimensional regularization:

$$\int \frac{d^4 q}{(2\pi)^4} \text{ is replaced by } \frac{\mu^{4-d} \Omega_d}{(2\pi)^d} \int_0^\infty |q|^{d-1} d|q|, \quad (2.124)$$

where Ω_d is the “area of the unit sphere in d dimension”, see (A.30). Thus

instead of (2.123) we consider its dimensionally regularized version:

$$\begin{aligned}
4\pi^{\text{E},d}(k^2) &= -\frac{\mu^{4-d}\Omega_d}{(2\pi)^d} \int_0^1 dv \int_0^\infty \frac{|q|^{d-1}}{(q^2 + \frac{k^2}{4}(1-v^2) + m^2)^2} d|q| \\
&\simeq -\frac{1}{(4\pi)^2} \int_0^1 dv \left(-\gamma + \log(\mu^2 4\pi) - \log\left(\frac{k^2}{4}(1-v^2) + m^2\right) \right) \\
&\quad - \frac{1}{(4\pi)^2(2-d/2)}. \tag{2.125}
\end{aligned}$$

To renormalize we demand that $\pi^{\text{E,ren}}(0) = 0$. Thus

$$\begin{aligned}
\pi^{\text{E,ren}}(k^2) &= \lim_{d \rightarrow 4} \left(\pi^{\text{E},d}(k^2) - \pi^{\text{E},d}(0) \right) \\
&= \frac{1}{4(4\pi)^2} \int_0^1 dv \log\left(1 + \frac{k^2}{4m^2}(1-v^2)\right),
\end{aligned}$$

which coincides with the Wick rotated result obtained by the Pauli-Villars method. Thus the renormalization of (2.125) amounts to choosing

$$\log \frac{\mu^2}{m^2} = \gamma - \log 4\pi, \tag{2.126}$$

dropping the pole term and setting $d = 4$.

2.3.14 Energy shift

Suppose that the perturbation does not depend on time and is given by a Schwartz function $\mathbb{R}^3 \ni \vec{x} \mapsto \kappa(\vec{x})$. The naive (Wick ordered) Hamiltonian is

$$\hat{H} := \int : \left(\frac{1}{2} \hat{\pi}^2(\vec{x}) + \frac{1}{2} (\vec{\partial} \hat{\phi}(\vec{x}))^2 + \frac{1}{2} (m^2 + \kappa(\vec{x})) \hat{\phi}^2(x) \right) : d\vec{x}$$

The infimum of a quadratic Wick ordered Hamiltonian can be computed exactly (A.19):

$$\begin{aligned}
E &= \text{Tr} \left(\frac{1}{2} (-\Delta + m^2 + \kappa)^{1/2} - \frac{1}{2} (-\Delta + m^2)^{1/2} - \frac{1}{4} (-\Delta + m^2)^{-1/2} \kappa \right) \\
&= \int \text{Tr} \left(\frac{-\Delta + m^2 + \kappa}{(-\Delta + m^2 + \kappa + \tau^2)} - \frac{-\Delta + m^2}{(-\Delta + m^2 + \tau^2)} - \frac{\tau^2}{(-\Delta + m^2 + \tau^2)^2} \kappa \right) \frac{d\tau}{2\pi} \\
&= \int \text{Tr} \left(\frac{\tau^2}{(-\Delta + m^2 + \tau^2)} - \frac{\tau^2}{(-\Delta + m^2 + \kappa + \tau^2)} - \frac{\tau^2}{(-\Delta + m^2 + \tau^2)^2} \kappa \right) \frac{d\tau}{2\pi} \\
&= - \int \text{Tr} \frac{1}{(-\Delta + m^2 + \tau^2)^2} \kappa \frac{1}{(-\Delta + m^2 + \kappa + \tau^2)} \kappa \tau^2 \frac{d\tau}{2\pi} \\
&= \sum_{n=2}^{\infty} (-1)^{n-1} \int \text{Tr} \frac{1}{(-\Delta + m^2 + \tau^2)^2} \kappa \left(\frac{1}{(-\Delta + m^2 + \tau^2)} \kappa \right)^{n-1} \tau^2 \frac{d\tau}{2\pi} \\
&= \sum_{n=2}^{\infty} \frac{(-1)^n}{2n} \int \text{Tr} \left(\frac{1}{(-\Delta + m^2 + \tau^2)} \kappa \right)^n \frac{d\tau}{2\pi}.
\end{aligned}$$

Above, we rewrote the square root by using the identities (A.35) and (A.36), expanded the denominator in the Neumann series and at the end we used the identity (A.37). Note that the n th term of the above expansion corresponds to the loop with n vertices. They are all well defined except for $n = 2$, which needs renormalization. We can guess that the renormalized energy shift is

$$E^{\text{ren}} = \int \pi^{\text{ren}}(0, \vec{k}) |\kappa(\vec{k})|^2 \frac{d\vec{k}}{(2\pi)^3} + \int \text{Tr} \frac{1}{(-\Delta + m^2 + \tau^2)} \kappa \quad (2.127)$$

$$\times \frac{1}{(-\Delta + m^2 + \tau^2)} \kappa \frac{1}{(-\Delta + m^2 + \kappa + \tau^2)} \kappa \frac{1}{(-\Delta + m^2 + \tau^2)} \tau^2 \frac{d\tau}{2\pi},$$

where we rewrote the sum of terms with $n \geq 3$ in a compact form, and π^{ren} was introduced in (2.114).

Another way to derive the expression for E^{ren} is to use Sucher's formula. We introduce the adiabatically switched perturbation $e^{-\epsilon|t|} \kappa(\vec{x})$ multiplied by a coupling constant λ , which will be put to 1 at the end. The Fourier transform of the switching factor $e^{-\epsilon|t|}$ is $\frac{2\epsilon}{\epsilon^2 + \tau^2}$. Therefore,

$$\mathcal{E}_\epsilon^{\text{ren}} = i \log(\Omega | \hat{S}_\epsilon^{\text{ren}} \Omega)$$

$$= \lambda^2 \int \pi^{\text{ren}}(\tau, \vec{k}) \frac{4\epsilon^2}{(\epsilon^2 + \tau^2)^2} |\kappa(\vec{k})|^2 \frac{d\tau d\vec{k}}{(2\pi)^4} + O(\lambda^3).$$

By Sucher's formula,

$$E^{\text{ren}} = \lim_{\epsilon \searrow 0} \frac{i\epsilon\lambda}{2} \partial_\lambda \log(\Omega | \hat{S}_\epsilon^{\text{ren}} \Omega)$$

$$= \lim_{\epsilon \searrow 0} \lambda^2 \int \pi^{\text{ren}}(\tau, \vec{k}) \frac{4\epsilon^3}{(\epsilon^2 + \tau^2)^2} |\kappa(\vec{k})|^2 \frac{d\tau d\vec{k}}{(2\pi)^4} + O(\lambda^3)$$

$$= \lambda^2 \int \pi^{\text{ren}}(0, \vec{k}) |\kappa(\vec{k})|^2 \frac{d\vec{k}}{(2\pi)^3} + O(\lambda^3),$$

where we used $\int \frac{4\epsilon^3}{(\epsilon^2 + \tau^2)^2} d\tau = 2\pi$. Eventually, we put $\lambda = 1$ and we obtain (2.127).

3 Massive photons

Let $m > 0$. In this section we discuss the quantization of the *Proca equation*

$$-\partial_\mu F^{\mu\nu}(x) + m^2 A^\nu(x) = 0, \quad (3.1)$$

where

$$F^{\mu\nu} := \partial^\mu A^\nu - \partial^\nu A^\mu. \quad (3.2)$$

Beside the free equation, we will also consider the Proca equation interacting with a given vector function J^μ , called an *external 4-current*:

$$-\partial_\mu F^{\mu\nu}(x) + m^2 A^\nu(x) = -J^\nu(x). \quad (3.3)$$

We will assume that the 4-current is *conserved*, that is

$$\partial_\nu J^\nu(x) = 0. \quad (3.4)$$

There are several possible approaches to the Proca equation on the classical and, especially, quantum level. In particular, one can use from the beginning the reduced phase space, both for the classical description and quantization. This is the approach that we will treat as the standard one. Alternative approaches will be discussed later.

3.1 Free massive photons

3.1.1 Space of solutions

Let \mathcal{Y}_{Pr} , resp. $\mathbb{C}\mathcal{Y}_{\text{Pr}}$ denote the set of real, resp. complex smooth space-compact solutions of the Proca equation

$$-\partial^\mu(\partial_\mu\zeta_\nu - \partial_\nu\zeta_\mu) + m^2\zeta_\nu(x) = 0. \quad (3.5)$$

It is easy to see that for $\zeta_1, \zeta_2 \in \mathbb{C}\mathcal{Y}_{\text{Pr}}$ the following expression defines a *conserved 4-current*:

$$\begin{aligned} & j_{\text{Pr}}^\mu(\zeta_1, \zeta_2, x) \\ := & (\partial^\mu\zeta_{1\nu}(x) - \partial_\nu\zeta_1^\mu(x))\zeta_2^\nu(x) - \zeta_{1\nu}(x)(\partial^\mu\zeta_2^\nu(x) - \partial^\nu\zeta_2^\mu(x)). \end{aligned} \quad (3.6)$$

\mathcal{Y}_{Pr} is a symplectic space with the *symplectic form*

$$\begin{aligned} \zeta_1 \omega_{\text{Pr}} \zeta_2 &= \int_{\mathcal{S}} j_{\text{Pr}}^\mu(\zeta_1, \zeta_2, x) ds_\mu(x) \\ &= \int \left(- \left(\dot{\vec{\zeta}}_1(t, \vec{x}) - \vec{\partial} \zeta_{10}(t, \vec{x}) \right) \vec{\zeta}_2(t, \vec{x}) + \vec{\zeta}_1(t, \vec{x}) \left(\dot{\vec{\zeta}}_2(t, \vec{x}) - \vec{\partial} \zeta_{20}(t, \vec{x}) \right) \right) d\vec{x}, \end{aligned} \quad (3.7)$$

where \mathcal{S} is any Cauchy surface.

The Poincaré group $\mathbb{R}^{1,3} \rtimes O(1,3)$ acts on \mathcal{Y}_{Pr} by

$$r_{(y,\Lambda)}\zeta_\mu(x) := \Lambda_\mu^\nu \zeta_\nu((y, \Lambda)^{-1}x).$$

$r_{(y,\Lambda)}$ are symplectic for $\Lambda \in O^\uparrow(1,3)$, otherwise they are antisymplectic.

3.1.2 Classical 4-potentials

We introduce the functionals $A_\mu(x)$ called *4-potentials*. They act on $\zeta \in \mathcal{Y}_{\text{Pr}}$ giving

$$\langle A_\mu(x) | \zeta \rangle := \zeta_\mu(x).$$

On $\mathcal{Y}_{\text{Pr}}^\#$ we have the action of the Poincaré group $(y, \Lambda) \mapsto r_{(y,\Lambda)}^{\#-1}$. Note that

$$r_{(y,\Lambda)}^{\#-1} A_\mu(x) = (\Lambda^{-1})_\mu^\nu A_\nu(\Lambda x + y).$$

We also introduce the *field tensor* and the *electric field vector*:

$$\begin{aligned} F_{\mu\nu}(x) &:= \partial_\mu A_\nu(x) - \partial_\nu A_\mu(x), \\ E_i(x) &:= F_{0i}(x) = \dot{A}_i - \partial_i A_0. \end{aligned}$$

Clearly, the free Proca equation (3.1) is satisfied. Equivalently, we have

$$(-\square + m^2)A_\mu(x) = 0, \quad (3.8)$$

$$\partial^\nu A_\nu(x) = 0. \quad (3.9)$$

Yet another equivalent system of equations convenient for further analysis is

$$(-\Delta + m^2)A_0 + \operatorname{div} \dot{\vec{A}} = 0, \quad (3.10)$$

$$(-\square + m^2)\vec{A} = 0. \quad (3.11)$$

(3.9) can be rewritten as

$$\dot{A}_0 = \operatorname{div} \vec{A}. \quad (3.12)$$

Thus only \vec{A} is dynamical: A_0 can be computed from \vec{A} . Taking the divergence of the definition of the electric field $\vec{E} = \dot{\vec{A}} - \vec{\partial}A_0$, then using (3.12) and (3.11), we can express A_0 in terms of \vec{E} :

$$m^2 A_0 = -\operatorname{div} \vec{E}. \quad (3.13)$$

Finally, we have the following version of the evolution equations in terms of \vec{E} , \vec{A} with only first order derivatives:

$$\dot{\vec{A}} = \vec{E} - \frac{1}{m^2} \vec{\partial} \operatorname{div} \vec{E}, \quad (3.14)$$

$$\dot{\vec{E}} = -(-\Delta + m^2)\vec{A} - \vec{\partial} \operatorname{div} \vec{A}. \quad (3.15)$$

3.1.3 Poisson brackets

The symplectic form on \mathcal{Y}_{Pr} (3.7) can be written as

$$\omega_{\text{Pr}} = \int \vec{A}(t, \vec{x}) \wedge \vec{E}(t, \vec{x}) d\vec{x}.$$

It leads to a *Poisson bracket* on functions on \mathcal{Y}_{Pr} :

$$\begin{aligned} \{A_i(t, \vec{x}), A_j(t, \vec{y})\} &= \{E_i(t, \vec{x}), E_j(t, \vec{y})\} = 0, \\ \{A_i(t, \vec{x}), E_j(t, \vec{y})\} &= \delta_{ij} \delta(\vec{x} - \vec{y}). \end{aligned} \quad (3.16)$$

We have

$$\{A_\mu(x), A_\nu(y)\} = \left(g_{\mu\nu} - \frac{\partial_\mu \partial_\nu}{m^2} \right) D(x - y),$$

where $D(x - y)$ is the Pauli-Jordan function.

Indeed, this follows after we insert (3.14), (3.13) and (3.12) into

$$\begin{aligned}\vec{A}(t, \vec{x}) &= \int \left(D(t, \vec{x} - \vec{y}) \dot{\vec{A}}(0, \vec{y}) + \dot{D}(t, \vec{x} - \vec{y}) \vec{A}(0, \vec{y}) \right) d\vec{y}, \\ A_0(t, \vec{x}) &= \int \left(D(t, \vec{x} - \vec{y}) \dot{A}_0(0, \vec{y}) + \dot{D}(t, \vec{x} - \vec{y}) A_0(0, \vec{y}) \right) d\vec{y},\end{aligned}$$

and then we commute them with $A_0(0, \vec{x})$ and $\vec{A}(0, \vec{x})$.

3.1.4 Smearred 4-potentials

We can use the symplectic form to pair distributions and solutions. For $\zeta \in \mathcal{Y}_{\text{Pr}}$, the corresponding *spatially smeared 4-potential* is the functional on \mathcal{Y}_{Pr} given by

$$\langle A((\zeta)) | \rho \rangle := \bar{\zeta} \omega \rho.$$

Note that

$$\begin{aligned}\{A((\zeta_1)), A((\zeta_2))\} &= \bar{\zeta}_1 \omega \bar{\zeta}_2. \\ A((\zeta)) &= \int \left(-\overline{(\dot{\zeta}(t, \vec{x}) - \partial \zeta^0(t, \vec{x}))} \vec{A}(t, \vec{x}) + \overline{\zeta(t, \vec{x})} \vec{E}(t, \vec{x}) \right) d\vec{x}. \quad (3.17)\end{aligned}$$

Another way of smearing the 4-potentials is also useful. For a space-time vector valued functions $f \in C_c^\infty(\mathbb{R}^{1,3}, \mathbb{R}^{1,3})$ the corresponding *space-time smeared 4-potential* is

$$A[f] := \int f_\mu(x) A^\mu(x) dx. \quad (3.18)$$

Note that $A[f] = A((\zeta))$, where

$$\zeta_\mu = -D * f_\mu + \frac{\partial_\mu \partial^\nu}{m^2} D * f_\nu.$$

Adding to f^μ a derivative $\partial^\mu \chi$ for $\chi \in C_c^\infty(\mathbb{R}^{1,3})$ does not change (3.18).

3.1.5 Lagrangian formalism and stress-energy tensor

Consider the Lagrangian density in the off-shell formalism

$$\mathcal{L} := -\frac{1}{4} F_{\mu\nu} F^{\mu\nu} - \frac{m^2}{2} A_\mu A^\mu.$$

The resulting Euler-Lagrange equations

$$\frac{\partial \mathcal{L}}{\partial A_\alpha} = \partial_\mu \left(\frac{\partial \mathcal{L}}{\partial A_{\alpha, \mu}} \right)$$

coincide with the Proca equation.

The *canonical stress-energy tensor*, which follows directly from the Noether Theorem, equals

$$\begin{aligned}\mathcal{T}_{\text{can}}^{\mu\nu} &= g^{\mu\nu}\mathcal{L} - \frac{\partial\mathcal{L}}{\partial A_{\alpha,\mu}}A_{\alpha}{}^{\nu} \\ &= -g^{\mu\nu}\left(\frac{1}{4}F_{\alpha\beta}F^{\alpha\beta} + \frac{m^2}{2}A_{\alpha}A^{\alpha}\right) + F^{\mu\alpha}A_{\alpha}{}^{\nu}.\end{aligned}$$

One usually prefers to replace it with the *Belifante-Rosenfeld stress-energy tensor*. It is defined as

$$\begin{aligned}\mathcal{T}^{\mu\nu} &= \mathcal{T}_{\text{can}}^{\mu\nu} + \partial_{\alpha}\Sigma^{\mu\nu\alpha} \\ &= -g^{\mu\nu}\left(\frac{1}{4}F_{\alpha\beta}F^{\alpha\beta} + \frac{m^2}{2}A_{\alpha}A^{\alpha}\right) + m^2A^{\mu}A^{\nu} + F^{\mu\alpha}F^{\nu}{}_{\alpha},\end{aligned}$$

where

$$\Sigma^{\mu\nu\alpha} = -\Sigma^{\alpha\nu\mu} := F^{\mu\alpha}A^{\nu}. \quad (3.19)$$

On solutions of the Euler-Lagrange equations we have

$$\partial_{\mu}\mathcal{T}_{\text{can}}^{\mu\nu} = \partial_{\mu}\mathcal{T}^{\mu\nu} = 0.$$

In addition, $\mathcal{T}^{\mu\nu}$ is symmetric.

As discussed before, the variables $A_0(x)$ are not dynamical. To pass to the Hamiltonian formalism, we introduce the variable conjugate to $A^i(x)$

$$\partial_{\dot{A}^i(x)}\mathcal{L}(x) = E_i(x).$$

The Hamiltonian and the momentum density obtained from the Belifante-Rosen tensor are

$$\begin{aligned}\mathcal{H}(x) := \mathcal{T}^{00}(x) &= \frac{1}{2}\vec{E}^2(x) + \frac{1}{2m^2}(\text{div}\vec{E})^2(x) + (\text{rot}\vec{A})^2(x) + \frac{m^2}{2}\vec{A}^2(x), \\ \mathcal{P}^j(x) := \mathcal{T}^{0j}(x) &= m^2A^0(x)A^j(x) + E^i(x)F^{ji}(x).\end{aligned}$$

The total Hamiltonian and momentum obtained from both Belifante-Rosen and canonical stress-energy tensor coincide:

$$\begin{aligned}H &:= \int \mathcal{H}(t, \vec{x})d\vec{x} = \int \mathcal{T}_{\text{can}}^{00}(t, \vec{x})d\vec{x}, \\ P^j &:= \int \mathcal{P}^j(t, \vec{x})d\vec{x} = \int \mathcal{T}_{\text{can}}^{0j}(t, \vec{x})d\vec{x}.\end{aligned}$$

Using (3.14) and (3.15) we check that H generates the equations of motion and \vec{P} the translations.

It is also natural to introduce

$$\mathcal{S}(x) := E_i(x)\epsilon^{ijk}\partial_k A_j(x), \quad (3.20)$$

and its spatial integral

$$S := \int \mathcal{S}(t, \vec{x}) d\vec{x}. \quad (3.21)$$

We are not aware of an established name of these quantities. We will call (3.20) the *polarization density* and (3.21) the *polarization*.

The observables H, \vec{P}, S are in involution.

3.1.6 Diagonalization of the equations of motion

For $\vec{k} \in \mathbb{R}^3$, $\vec{k} \neq \vec{0}$ fix two spatial vectors $\vec{e}_1(\vec{k}), \vec{e}_2(\vec{k})$ that form an oriented orthonormal basis of the plane orthogonal to \vec{k} . Define

$$\vec{e}(\vec{k}, \pm 1) := \frac{1}{\sqrt{2}} \left(\vec{e}_1(\vec{k}) \pm i\vec{e}_2(\vec{k}) \right).$$

Note that

$$\begin{aligned} \vec{k} \times \vec{e}(\vec{k}, \pm 1) &= \pm i|\vec{k}|\vec{e}_\pm(\vec{k}), \\ \vec{e}(\vec{k}, \sigma) \cdot \vec{k} &= 0, \\ \overline{e_i(\vec{k}, \sigma)} e_i(\vec{k}, \sigma') &= \delta_{\sigma, \sigma'}, \\ \sum_{\sigma=\pm 1} \overline{e_i(\vec{k}, \sigma)} e_j(\vec{k}, \sigma) &= \delta_{ij} - \frac{k_i k_j}{k^2}. \end{aligned}$$

Let $k \in \mathbb{R}^{1,3}$ with $k^0 = \varepsilon(\vec{k}) = \sqrt{k^2 + m^2}$. Introduce

$$u(k, 0) := \left(\frac{|\vec{k}|}{m}, \frac{\varepsilon(\vec{k})\vec{k}}{m|\vec{k}|} \right), \quad (3.22)$$

$$u(k, \pm 1) := \left(0, \vec{e}(\vec{k}, \pm 1) \right). \quad (3.23)$$

Note that

$$\begin{aligned} u_\mu(k, \sigma) k^\mu &= 0, \\ \overline{u_\mu(k, \sigma)} u^\mu(k, \sigma') &= \delta_{\sigma, \sigma'}, \\ \sum_{\sigma=0, \pm 1} \overline{u_\mu(k, \sigma)} u_\nu(k, \sigma) &= g_{\mu\nu} + \frac{k_\mu k_\nu}{m^2}. \end{aligned}$$

Set

$$\begin{aligned} \vec{A}_t(\vec{k}) &= \int \vec{A}(t, \vec{x}) e^{-i\vec{k}\cdot\vec{x}} \frac{d\vec{x}}{\sqrt{(2\pi)^3}}, \\ \vec{E}_t(\vec{k}) &= \int \vec{E}(t, \vec{x}) e^{-i\vec{k}\cdot\vec{x}} \frac{d\vec{x}}{\sqrt{(2\pi)^3}}. \end{aligned}$$

We have the equations of motion

$$\begin{aligned}\dot{\vec{A}}_t(\vec{k}) &= \vec{E}_t(\vec{k}) + \frac{\vec{k}}{m^2} \vec{k} \cdot \vec{E}_t(\vec{k}), \\ \dot{\vec{E}}_t(\vec{k}) &= -(\vec{k}^2 + m^2) \vec{A}_t(\vec{k}) + \vec{k} \vec{k} \cdot \vec{A}_t(\vec{k}),\end{aligned}$$

the relations

$$A_i^*(\vec{k}) = A_i(-\vec{k}), \quad E_i^*(\vec{k}) = E_i(-\vec{k}),$$

and the Poisson brackets

$$\begin{aligned}\{A_{ti}^*(\vec{k}), A_{tj}(\vec{k}')\} &= \{E_{ti}^*(\vec{k}), E_{tj}(\vec{k}')\} = 0, \\ \{A_{ti}^*(\vec{k}), E_{tj}(\vec{k}')\} &= \delta_{ij} \delta(\vec{k} - \vec{k}').\end{aligned}$$

Set

$$\begin{aligned}A_t(\vec{k}, \pm 1) &:= \overline{\vec{e}(\vec{k}, \pm 1)} \cdot \vec{A}_t(\vec{k}), \\ E_t(\vec{k}, \pm 1) &:= \overline{\vec{e}(\vec{k}, \pm 1)} \cdot \vec{E}_t(\vec{k}), \\ A_t(\vec{k}, 0) &:= \frac{m}{\varepsilon(\vec{k})} \frac{\vec{k}}{|\vec{k}|} \cdot \vec{A}_t(\vec{k}), \\ E_t(\vec{k}, 0) &:= \frac{\varepsilon(\vec{k})}{m} \frac{\vec{k}}{|\vec{k}|} \cdot \vec{E}_t(\vec{k}).\end{aligned}$$

We have the equations of motion

$$\begin{aligned}\dot{A}_t(\vec{k}, \sigma) &= E_t(\vec{k}, \sigma), \\ \dot{E}_t(\vec{k}, \sigma) &= -\varepsilon(\vec{k})^2 A_t(\vec{k}, \sigma).\end{aligned}$$

the relations

$$A_t^*(\vec{k}, \sigma) = A_t(-\vec{k}, -\sigma), \quad E_t^*(\vec{k}, \sigma) = E_t(-\vec{k}, -\sigma),$$

and the Poisson brackets

$$\begin{aligned}\{A_t^*(\vec{k}, \sigma), A_t(\vec{k}', \sigma')\} &= \{E_t^*(\vec{k}, \sigma), E_t(\vec{k}', \sigma')\} = 0, \\ \{A_t^*(\vec{k}, \sigma), E_t(\vec{k}', \sigma')\} &= \delta_{\sigma\sigma'} \delta(\vec{k} - \vec{k}').\end{aligned} \tag{3.24}$$

We set

$$\begin{aligned}a_t(k, \sigma) &:= \sqrt{\frac{\varepsilon(\vec{k})}{2}} A_t(\vec{k}, \sigma) + \frac{i}{\sqrt{2\varepsilon(\vec{k})}} E_t(\vec{k}, \sigma), \\ a_t^*(k, \sigma) &:= \sqrt{\frac{\varepsilon(\vec{k})}{2}} A_t^*(\vec{k}, \sigma) - \frac{i}{\sqrt{2\varepsilon(\vec{k})}} E_t^*(\vec{k}, \sigma).\end{aligned}$$

We have the equations of motion

$$\begin{aligned}\dot{a}_t(k, \sigma) &= -i\varepsilon(\vec{k})a_t(k, \sigma), \\ \dot{a}_t^*(k, \sigma) &= i\varepsilon(\vec{k})a_t^*(k, \sigma).\end{aligned}$$

We will usually write $a(k, \sigma)$, $a^*(k, \sigma)$ for $a_0(k, \sigma)$, $a_0^*(k, \sigma)$, so that

$$\begin{aligned}a_t(k, \sigma) &= e^{-it\varepsilon(\vec{k})}a(k, \sigma), \\ a_t^*(k, \sigma) &= e^{it\varepsilon(\vec{k})}a^*(k, \sigma).\end{aligned}$$

The direct definitions of $a(k, \sigma)$, $a^*(k, \sigma)$ are

$$\begin{aligned}a(k, \pm 1) &= \int \frac{d\vec{x}}{\sqrt{(2\pi)^3}} e^{-i\vec{k}\vec{x}} \left(\sqrt{\frac{\varepsilon(\vec{k})}{2}} \overline{\vec{e}(\vec{k}, \pm 1)} \vec{A}(0, \vec{x}) + \frac{i}{\sqrt{2\varepsilon(\vec{k})}} \overline{\vec{e}(\vec{k}, \pm 1)} \vec{E}(0, \vec{x}) \right), \\ a^*(k, \pm 1) &= \int \frac{d\vec{x}}{\sqrt{(2\pi)^3}} e^{i\vec{k}\vec{x}} \left(\sqrt{\frac{\varepsilon(\vec{k})}{2}} \vec{e}(\vec{k}, \pm 1) \vec{A}(0, \vec{x}) - \frac{i}{\sqrt{2\varepsilon(\vec{k})}} \vec{e}(\vec{k}, \pm 1) \vec{E}(0, \vec{x}) \right), \\ a(k, 0) &= \int \frac{d\vec{x}}{\sqrt{(2\pi)^3}} e^{-i\vec{k}\vec{x}} \left(\frac{m}{\sqrt{2\varepsilon(\vec{k})}} \frac{\vec{k}}{|\vec{k}|} \vec{A}(0, \vec{x}) + \frac{i}{m} \sqrt{\frac{\varepsilon(\vec{k})}{2}} \frac{\vec{k}}{|\vec{k}|} \vec{E}(0, \vec{x}) \right), \\ a^*(k, 0) &= \int \frac{d\vec{x}}{\sqrt{(2\pi)^3}} e^{i\vec{k}\vec{x}} \left(\frac{m}{\sqrt{2\varepsilon(\vec{k})}} \frac{\vec{k}}{|\vec{k}|} \vec{A}(0, \vec{x}) - \frac{i}{m} \sqrt{\frac{\varepsilon(\vec{k})}{2}} \frac{\vec{k}}{|\vec{k}|} \vec{E}(0, \vec{x}) \right).\end{aligned}$$

Their Poisson brackets are

$$\begin{aligned}\{a(\vec{k}, \sigma), a(\vec{k}', \sigma')\} &= \{a^*(\vec{k}, \sigma), a^*(\vec{k}', \sigma')\} = 0, \\ \{a(\vec{k}, \sigma), a^*(\vec{k}', \sigma')\} &= -i\delta(\vec{k} - \vec{k}')\delta_{\sigma, \sigma'}.\end{aligned}$$

The 4-potentials can be written as

$$A_\mu(x) = \sum_{\sigma=0, \pm 1} \int \frac{d\vec{k}}{\sqrt{(2\pi)^3} \sqrt{2\varepsilon(\vec{k})}} \left(u_\mu(k, \sigma) e^{ikx} a(k, \sigma) + \overline{u_\mu(k, \sigma)} e^{-ikx} a^*(k, \sigma) \right).$$

We have accomplished the diagonalization of the Hamiltonian, momentum, polarization and symplectic form:

$$\begin{aligned}
H &= \sum_{\sigma=0,\pm 1} \int d\vec{k} \varepsilon(\vec{k}) a^*(k, \sigma) a(k, \sigma), \\
\vec{P} &= \sum_{\sigma=0,\pm 1} \int d\vec{k} \vec{k} a^*(k, \sigma) a(k, \sigma), \\
S &= \sum_{\sigma=0,\pm 1} \int d\vec{k} \sigma |\vec{k}| a^*(k, \sigma) a(k, \sigma), \\
i\omega &= \sum_{\sigma=0,\pm 1} \int a^*(k, \sigma) \wedge a(k, \sigma) d\vec{k}.
\end{aligned}$$

3.1.7 Plane waves

A *plane wave* is defined as

$$|k, \sigma\rangle^\mu = \frac{1}{\sqrt{(2\pi)^3} \sqrt{2\varepsilon(\vec{k})}} u^\mu(k, \sigma) e^{ikx}, \quad (3.25)$$

with $k^0 = \varepsilon(\vec{k}) = \sqrt{\vec{k}^2 + m^2}$. We have

$$\begin{aligned}
i(\overline{k}, \sigma | \omega | k', \sigma') &= i(k, \sigma | \omega | \overline{k}', \sigma') = 0, \\
i(\overline{k}, \sigma | \omega | \overline{k}', \sigma') &= -i(k, \sigma | \omega | k', \sigma') = \delta(\vec{k} - \vec{k}') \delta_{\sigma, \sigma'}.
\end{aligned}$$

$a(k, \sigma)$ can be called *plane wave functionals*:

$$\begin{aligned}
a(k, \sigma) &= -iA(|k, \sigma\rangle) \\
&= -i \int \left((\partial_t(k, \sigma|x)_i - \partial_i(k, \sigma|x)_0) A_i(0, \vec{x}) - (k, \sigma|x)_i E_i(0, \vec{x}) \right) d\vec{x}, \\
a^*(k, \sigma) &= iA(|-k, \sigma\rangle) \\
&= i \int \left((\partial_t(\overline{k}, \sigma|x)_i - \partial_i(\overline{k}, \sigma|x)_0) A_i(0, \vec{x}) - (\overline{k}, \sigma|x)_i E_i(0, \vec{x}) \right) d\vec{x}.
\end{aligned}$$

3.1.8 Positive frequency space

$\mathcal{W}_{\text{Pr}}^{(+)}$ will denote the subspace of $\mathbb{C}\mathcal{Y}_{\text{Pr}}$ consisting of *positive frequency solutions*:

$$\mathcal{W}_{\text{Pr}}^{(+)} := \{g \in \mathbb{C}\mathcal{Y}_{\text{Pr}} : \overline{(k, \sigma)} \omega g = 0, \sigma = \pm, 0\}.$$

Every $g \in \mathcal{W}_{\text{Pr}}^{(+)}$ can be written as

$$g_\mu(x) = \sum_{\sigma=0,\pm 1} \int \frac{d\vec{k}}{\sqrt{(2\pi)^3} \sqrt{2\varepsilon(\vec{k})}} e^{ikx} u_\mu(k, \sigma) \langle a(k, \sigma) | g \rangle.$$

For $g_1, g_2 \in \mathcal{W}_{\text{Pr}}^{(+)}$ we define the scalar product

$$(g_1|g_2) := i\bar{g}_1\omega g_2 = \sum_{\sigma=0,\pm 1} \int \overline{\langle a(k,\sigma)|g_1 \rangle} \langle a(k,\sigma)|g_2 \rangle d\vec{k}. \quad (3.26)$$

We set \mathcal{Z}_{Pr} to be the completion of $\mathcal{W}_{\text{Pr}}^{(+)}$ in this scalar product. $\mathbb{R}^{1,3} \times O^\uparrow(1,3)$ leaves \mathcal{Z}_{Pr} invariant.

We have

$$\langle a(k,\sigma)|g \rangle = (k,\sigma|g).$$

We can identify \mathcal{Z}_{Pr} with $L^2(\mathbb{R}^3, \mathbb{C}^3)$ and rewrite (3.26) as

$$(g_1|g_2) = \sum_{\sigma=0,\pm 1} \int \overline{(k,\sigma|g_1)} (k,\sigma|g_2) d\vec{k}.$$

3.1.9 Spin averaging

For a given $k \in \mathbb{R}^{1,3}$ with $k^2 = m^2$, let M, N be vectors with

$$M^\mu k_\mu = N^\nu k_\nu = 0.$$

The following identity allows us to *average over spin* and is useful in computations of scattering cross-sections:

$$\sum_{\sigma=0,\pm 1} \overline{M^\mu u_\mu(k,\sigma)} u_\nu(k,\sigma) N^\nu = \overline{M^\mu} N_\nu. \quad (3.27)$$

In fact,

$$\sum_{\sigma=0,\pm 1} \overline{u_\mu(k,\sigma)} u_\nu(k,\sigma) = g_{\mu\nu} + \frac{k_\mu k_\nu}{m^2}.$$

Therefore, the left hand side of (3.27) equals

$$\overline{M^\mu} g_{\mu\nu} N^\nu + \frac{(\overline{M} \cdot k)(N \cdot k)}{m^2}.$$

But

$$k \cdot M = k \cdot N = 0.$$

3.1.10 Quantization

We want to construct $(\mathcal{H}, \hat{H}, \Omega)$ satisfying the standard requirements of QM (1)-(3) and a self-adjoint operator-valued distribution $\mathbb{R}^{1,3} \ni x \mapsto \hat{A}_\mu(x)$ such

that, setting $\vec{\hat{E}} = \vec{\hat{A}} - \vec{\partial} \hat{A}_0$, we have

- (1) $-\partial^\mu (\partial_\mu \hat{A}_\nu - \partial_\nu \hat{A}_\mu) + m^2 \hat{A}_\nu(x) = 0;$
- (2) $[\hat{A}_i(0, \vec{x}), \hat{A}_j(0, \vec{y})] = [\hat{E}_i(0, \vec{x}), \hat{E}_j(0, \vec{y})] = 0,$
 $[\hat{A}_i(0, \vec{x}), \hat{E}_j(0, \vec{y})] = i\delta_{ij} \delta(\vec{x} - \vec{y});$

$$(3) \quad e^{it\hat{H}}\hat{A}_\mu(x^0, \vec{x})e^{-it\hat{H}} = \hat{A}_\mu(x^0 + t, \vec{x});$$

$$(4) \quad \Omega \text{ is cyclic for } \hat{A}_\mu(x).$$

The above problem has an essentially unique solution, which we describe below.

For the Hilbert space we should take the bosonic Fock space $\mathcal{H} = \Gamma_s(\mathcal{Z}_{\text{Pr}})$ and for Ω the Fock vacuum. With $\mathcal{Z}_{\text{Pr}} \simeq L^2(\mathbb{R}^3, \mathbb{C}^3)$ and k on shell we have creation operators

$$\hat{a}^*(k, \sigma) = \hat{a}^*(|k, \sigma\rangle),$$

written in both “physicist’s” and “mathematician’s notation” satisfying

$$\begin{aligned} [\hat{a}(k, \sigma), \hat{a}(k', \sigma')] &= [\hat{a}^*(k, \sigma), \hat{a}^*(k', \sigma')] = 0, \\ [\hat{a}(k, \sigma), \hat{a}^*(k', \sigma')] &= \delta(\vec{k} - \vec{k}')\delta_{\sigma, \sigma'}. \end{aligned}$$

Therefore the *quantum 4-potentials*

$$\begin{aligned} &\hat{A}_\mu(x) \\ &= \sum_{\sigma=0, \pm 1} \left(u_\mu(k, \sigma)e^{ikx}\hat{a}(k, \sigma) + \overline{u_\mu(k, \sigma)}e^{-ikx}\hat{a}^*(k, \sigma) \right) \end{aligned} \quad (3.28)$$

satisfy the required commutation relations. The *quantum Hamiltonian, momentum and polarization* are

$$\begin{aligned} \hat{H} &= \sum_{\sigma=0, \pm 1} \int \varepsilon(\vec{k})\hat{a}^*(k, \sigma)\hat{a}(k, \sigma)d\vec{k}, \\ \vec{\hat{P}} &= \sum_{\sigma=0, \pm 1} \int \vec{k}\hat{a}^*(k, \sigma)\hat{a}(k, \sigma)d\vec{k}, \\ \hat{S} &= \sum_{\sigma=0, \pm 1} \int \sigma|\vec{k}|\hat{a}^*(k, \sigma)\hat{a}(k, \sigma)d\vec{k}. \end{aligned}$$

The group $\mathbb{R}^{1,3} \times O^\uparrow(1, 3)$ is unitarily implemented on \mathcal{H} by $U(y, \Lambda) := \Gamma\left(r_{(y, \Lambda)} \Big|_{\mathcal{Z}_{\text{Pr}}}\right)$. We have

$$U(y, \Lambda)\hat{A}_\mu(x)U(y, \Lambda)^* = \Lambda_\mu^\nu \hat{A}_\nu((y, \Lambda)x).$$

Moreover,

$$[\hat{A}_\mu(x), \hat{A}_\nu(y)] = -i \left(g_{\mu\nu} - \frac{\partial_\mu \partial_\nu}{m^2} \right) D(x - y).$$

Note the identities

$$\begin{aligned} (\Omega|\hat{A}_\mu(x)\hat{A}_\nu(y)\Omega) &= -i \left(g_{\mu\nu} - \frac{\partial_\mu \partial_\nu}{m^2} \right) D^{(+)}(x - y), \\ (\Omega|\mathbb{T}(\hat{A}_\mu(x)\hat{A}_\nu(y))\Omega) &= -i \left(g_{\mu\nu} - \frac{\partial_\mu \partial_\nu}{m^2} \right) D^c(x - y). \end{aligned} \quad (3.29)$$

For $f \in C_c^\infty(\mathbb{R}^{1,3}, \mathbb{R}^{1,3})$ set

$$\hat{A}[f] := \int f^\mu(x) \hat{A}_\mu(x) dx.$$

We obtain a family that satisfies the Wightman axioms with $\mathcal{D} := \Gamma_s^{\text{fin}}(\mathcal{Z}_{\text{Pr}})$.

For an open set $\mathcal{O} \subset \mathbb{R}^d$ we set

$$\mathfrak{A}(\mathcal{O}) := \left\{ \exp(i\hat{A}[f]) : f \in C_c^\infty(\mathcal{O}, \mathbb{R}^{1,3}) \right\}.$$

The algebras $\mathfrak{A}(\mathcal{O})$ satisfy the Haag-Kastler axioms.

3.2 Massive photons with an external 4-current

3.2.1 Classical 4-potentials

We return to the classical Proca equation. We assume that

$$\mathbb{R}^{1,3} \ni x \mapsto J(x) = [J^\mu(x)] \in \mathbb{R}^{1,3} \quad (3.30)$$

is a given function called an *external 4-current*, which satisfies

$$\partial_\nu J^\nu(x) = 0. \quad (3.31)$$

In most of this subsection we will assume that (3.30) is Schwartz.

In its presence the Proca equation takes the form

$$-\partial^\mu(\partial_\mu A^\nu - \partial^\nu A_\mu) + m^2 A^\nu(x) = -J^\nu(x). \quad (3.32)$$

Note that (3.32) and (3.31) imply the *Lorentz condition*

$$\partial_\nu A^\nu(x) = 0. \quad (3.33)$$

We have therefore

$$(-\square + m^2)A^\mu(x) = -J^\mu(x). \quad (3.34)$$

The temporal component of (3.32) has no time derivative:

$$-\Delta A_0 + \partial_0 \text{div} \vec{A} + m^2 A_0 = -J_0. \quad (3.35)$$

Therefore, we can compute A_0 in terms of \vec{A} at the same time:

$$A_0 = -(-\Delta + m^2)^{-1}(\partial_0 \text{div} \vec{A} + J_0). \quad (3.36)$$

The only dynamical variables are the spatial components, satisfying the equation

$$(\partial_0^2 - \Delta + m^2)\vec{A} = -\vec{J}. \quad (3.37)$$

3.2.2 Lagrangian and Hamiltonian formalism

The Lagrangian density is

$$\begin{aligned}
\mathcal{L} &:= -\frac{1}{4}F_{\mu\nu}F^{\mu\nu} - \frac{m^2}{2}A_\mu A^\mu - J_\mu A^\mu \\
&= -\frac{1}{2}\partial_\mu A_\nu \partial^\mu A^\nu - \frac{1}{2}\partial_\mu A_\nu \partial^\nu A^\mu - \frac{m^2}{2}A_\mu A^\mu - J_\mu A^\mu \\
&= -\frac{1}{2}(\text{rot}\vec{A})^2 + \frac{1}{2}(\vec{\partial}A_0)^2 + \frac{1}{2}(\dot{\vec{A}})^2 - \dot{\vec{A}}\vec{\partial}A_0 + \frac{m^2}{2}A_0^2 - \frac{m^2}{2}\vec{A}^2 - \vec{J}\vec{A} + J_0A_0.
\end{aligned}$$

As noted before, only spatial components $\vec{A}(x)$ are dynamical and the conjugate variable is $\vec{E}(x) = \dot{\vec{A}}(x) - \vec{\partial}A_0(x)$. Thus we have the standard Poisson brackets:

$$\begin{aligned}
\{A_i(t, \vec{x}), A_j(t, \vec{y})\} &= \{E_i(t, \vec{x}), E_j(t, \vec{y})\} = 0, \\
\{A_i(t, \vec{x}), E_j(t, \vec{y})\} &= \delta_{ij}\delta(\vec{x} - \vec{y}). \quad (3.38)
\end{aligned}$$

We can compute A_0 in terms of \vec{E} :

$$A_0 = -\frac{1}{m^2}(J_0 + \text{div}\vec{E}). \quad (3.39)$$

The *canonical Hamiltonian density* is

$$\begin{aligned}
\mathcal{H}^{\text{can}}(x) &= -\mathcal{L}(x) + \frac{\partial\mathcal{L}(x)}{\partial\dot{A}_i(x)}\dot{A}_i(x) \\
&= \frac{1}{2}(\text{rot}\vec{A})^2(x) - \frac{1}{2}(\vec{\partial}A_0)^2(x) - \frac{1}{2}(\dot{\vec{A}})^2(x) \\
&\quad - \frac{m^2}{2}A_0^2(x) + \frac{m^2}{2}\vec{A}^2(x) + \vec{J}(x)\vec{A}(x) - J_0(x)A_0(x).
\end{aligned}$$

We add to it a spatial divergence $\text{div}(\vec{E}(x)A^0(x))$ and express it in terms of \vec{A} , \vec{E} , obtaining the usual Hamiltonian density

$$\begin{aligned}
\mathcal{H}(x) &:= \frac{1}{2}\vec{E}^2(x) + \frac{1}{2}(\text{rot}\vec{A})^2(x) \\
&\quad + \frac{m^2}{2}A_0^2(x) + \frac{m^2}{2}\vec{A}^2(x) + \vec{J}(x)\vec{A}(x).
\end{aligned}$$

The Hamiltonian

$$H(t) = \int \mathcal{H}(t, \vec{x})d\vec{x} = \int \mathcal{H}^{\text{can}}(t, \vec{x})d\vec{x} \quad (3.40)$$

generates the equations of motion. Using the splitting of \vec{A} and \vec{E} into the

transversal and longitudinal part, as in (A.41), we can rewrite $H(t)$ as

$$\begin{aligned}
H(t) &= \int d\vec{x} \left(\frac{1}{2} \vec{E}_{\text{tr}}^2(t, \vec{x}) + \frac{1}{2} \vec{A}_{\text{tr}}(t, \vec{x}) (-\Delta + m^2) \vec{A}_{\text{tr}}(t, \vec{x}) + \vec{J}(x) \vec{A}_{\text{tr}}(x) \right) \\
&\quad + \int d\vec{x} \left(\frac{1}{2} ((-\Delta)^{-1/2} \text{div} \vec{E}(t, \vec{x}))^2 + \frac{1}{2m^2} (J^0(t, \vec{x}) - \text{div} \vec{E}(t, \vec{x}))^2 \right. \\
&\quad \left. + \frac{m^2}{2} ((-\Delta)^{-1/2} \text{div} \vec{A}(t, \vec{x}))^2 \right). \tag{3.41}
\end{aligned}$$

We can interpret interacting fields as functionals on \mathcal{Y}_{Pr} satisfying

$$\vec{A}(0, \vec{x}) = \vec{A}_{\text{fr}}(0, \vec{x}), \quad \vec{E}(0, \vec{x}) = \vec{E}_{\text{fr}}(0, \vec{x}).$$

3.2.3 Quantization

We are looking for operator valued distributions $\mathbb{R}^{1,3} \ni x \mapsto \hat{A}_\mu(x)$ satisfying

$$-\partial_\mu (\partial^\mu \hat{A}^\nu(x) - \partial^\nu \hat{A}^\mu(x)) + m^2 \hat{A}^\nu(x) = -J^\nu(x),$$

having the standard equal time commutation relations with $\hat{E}^i := \dot{\hat{A}}^i - \partial_i \hat{A}_0$

$$\begin{aligned}
[\hat{A}_i(0, \vec{x}), \hat{A}_j(0, \vec{y})] &= [\hat{E}_i(0, \vec{x}), \hat{E}_j(0, \vec{y})] = 0, \\
[\hat{A}_i(0, \vec{x}), \hat{E}_j(0, \vec{y})] &= i\delta_{ij} \delta(\vec{x} - \vec{y}).
\end{aligned}$$

We will assume that $\vec{\hat{A}}, \vec{\hat{E}}$ coincide with free fields at $t = 0$:

$$\begin{aligned}
\hat{A}^i(\vec{x}) &:= \hat{A}^i(0, \vec{x}) = \hat{A}_{\text{fr}}^i(0, \vec{x}), \\
\hat{E}^i(\vec{x}) &:= \hat{E}^i(0, \vec{x}) = \hat{E}_{\text{fr}}^i(0, \vec{x}).
\end{aligned}$$

We have

$$\hat{A}_\mu(t, \vec{x}) := \text{Texp} \left(-i \int_t^0 \hat{H}(s) ds \right) \hat{A}_\mu(\vec{x}) \text{Texp} \left(-i \int_0^t \hat{H}(s) ds \right),$$

where the Hamiltonian $\hat{H}(t)$, and the corresponding Hamiltonian in the interaction picture are

$$\begin{aligned}
\hat{H}(t) &= \int d\vec{x} : \left(\frac{1}{2} \vec{\hat{E}}^2(\vec{x}) + \frac{1}{2m^2} (J^0(t, \vec{x}) - \text{div} \vec{\hat{E}}(\vec{x}))^2 \right. \\
&\quad \left. + \frac{1}{2} (\text{rot} \vec{\hat{A}})^2(\vec{x}) + \frac{m^2}{2} \vec{\hat{A}}^2(\vec{x}) + \vec{J}(t, \vec{x}) \vec{\hat{A}}(\vec{x}) \right) : \\
\hat{H}_{\text{Int}}(t) &= \int d\vec{x} \left(-\frac{1}{m^2} J^0(t, \vec{x}) \text{div} \vec{\hat{E}}_{\text{fr}}(t, \vec{x}) + \vec{J}(t, \vec{x}) \vec{\hat{A}}_{\text{fr}}(t, \vec{x}) + \frac{1}{2m^2} J^0(t, \vec{x})^2 \right).
\end{aligned}$$

Using (3.28) and $\text{div}\vec{E}_{\text{fr}} = -(-\Delta + m^2)^{-1}\text{div}\vec{A}_{\text{fr}}$, we express the interaction picture Hamiltonian in terms of creation/annihilation operators:

$$\begin{aligned}\hat{H}_{\text{Int}}(t) &= \int \frac{d\vec{k}}{\sqrt{(2\pi)^3}\sqrt{2\varepsilon(\vec{k})}} \left(e^{it\varepsilon(\vec{k})} J_\mu(t, \vec{k}) \overline{u^\mu(\vec{k}, \sigma)} \hat{a}^*(k, \sigma) \right. \\ &\quad \left. + e^{-it\varepsilon(\vec{k})} \overline{J_\mu(t, \vec{k})} u^\mu(\vec{k}, \sigma) \hat{a}(k, \sigma) \right) + \int \frac{d\vec{k}}{(2\pi)^3} \frac{|J^0(t, \vec{k})|^2}{2m^2}.\end{aligned}$$

We can compute the scattering operator

$$\begin{aligned}\hat{S} &= \exp\left(-\frac{i}{2} \int \frac{dk}{(2\pi)^4} \overline{J^\mu(k)} D_{\mu\nu}^0(k) J^\nu(k)\right) \\ &\quad \times \exp\left(-i \sum_{\sigma=0,\pm 1} \int \frac{d\vec{k}}{\sqrt{(2\pi)^3}} a^*(k, \sigma) \frac{\overline{u_\mu(k, \sigma)}}{\sqrt{2\varepsilon(\vec{k})}} J^\mu(\varepsilon(\vec{k}), \vec{k})\right) \\ &\quad \times \exp\left(-i \sum_{\sigma=0,\pm 1} \int \frac{d\vec{k}}{\sqrt{(2\pi)^3}} a(k, \sigma) \frac{u_\mu(k, \sigma)}{\sqrt{2\varepsilon(\vec{k})}} \overline{J^\mu(\varepsilon(\vec{k}), \vec{k})}\right),\end{aligned}$$

where

$$D_{\mu\nu}^0(k) = \frac{1}{m^2 + k^2 - i0} \left(g_{\mu\nu} + \frac{k_\mu k_\nu}{m^2} \right). \quad (3.42)$$

(The superscript 0 over $D_{\mu\nu}^0$ will be explained later on).

For x_N, \dots, x_1 , the N -point Green's function is defined as follows:

$$\begin{aligned}&\langle \hat{A}_{\mu_N}(x_N) \dots \hat{A}_{\mu_1}(x_1) \rangle \\ &:= \left(\Omega^+ | \text{T}(\hat{A}_{\mu_N}(x_N) \dots \hat{A}_{\mu_1}(x_1)) \Omega^- \right).\end{aligned}$$

Green functions can be organized into the *generating function*

$$\begin{aligned}&\sum_{n=0}^{\infty} \int \dots \int \langle \hat{A}_{\mu_N}(x_N) \dots \hat{A}_{\mu_1}(x_1) \rangle (-i)^N f^{\mu_N}(x_N) \dots f^{\mu_1}(x_1) dx_N \dots dx_1 \\ &= \left(\Omega | \text{T} \exp \left(-i \int_{-\infty}^{\infty} \hat{H}_{\text{Int}}(s) ds - i \int f^\mu(x) \hat{A}_\mu(x) dx \right) \Omega \right) =: Z(f).\end{aligned}$$

The *amputated N -point Green's functions* are

$$\begin{aligned}&\langle \hat{A}_{\mu_N}(k_N) \dots \hat{A}_{\mu_1}(k_1) \rangle_{\text{amp}} \\ &:= (k_N^2 + m^2) \dots (k_1^2 + m^2) \langle \hat{A}_{\mu_N}(k_N) \dots \hat{A}_{\mu_1}(k_1) \rangle.\end{aligned}$$

For k_1, \dots, k_N on shell, set

$$|k_N, \sigma_N, \dots, k_1, \sigma_1\rangle := \hat{a}^*(k_N, \sigma_N) \dots \hat{a}^*(k_1, \sigma_1) \Omega.$$

Amputated Green's functions can be used to compute *scattering amplitudes*:

$$\begin{aligned}
& \left(k_{n_+}^+, \sigma_{n_+}^+, \dots, k_1^+, \sigma_1^+ | \hat{S} | k_{n_-}^-, \sigma_{n_-}^-, \dots, k_1^-, \sigma_1^- \right) \\
&= \frac{\overline{u^{\mu_1^+}(k_1^+, \sigma_1^+)} \cdots \overline{u^{\mu_{n_+}^+}(k_{n_+}^+, \sigma_{n_+}^+)} u^{\mu_{n_-}^-}(k_{n_-}^-, \sigma_{n_-}^-) \cdots u^{\mu_1^-}(k_1^-, \sigma_1^-)}{(2\pi)^{\frac{n^+ + n^-}{2}} \sqrt{2\varepsilon(k_1^+)} \cdots \sqrt{2\varepsilon(k_{n_+}^+)} \sqrt{2\varepsilon(k_{n_-}^-)} \cdots \sqrt{2\varepsilon(k_1^-)}} \\
& \times \langle \hat{A}_{\mu_1^+}(k_1^+) \cdots \hat{A}_{\mu_{n_+}^+}(k_{n_+}^+) \hat{A}_{\mu_{n_-}^-}(-k_{n_-}^-) \cdots \hat{A}_{\mu_1^-}(-k_1^-) \rangle_{\text{amp}}.
\end{aligned}$$

3.2.4 Causal propagators

The causal propagator used to compute Green's functions and scattering amplitudes that follows directly from the interaction picture Hamiltonian is $\left(g_{\mu\nu} - \frac{\partial_\mu \partial_\nu}{m^2} \right) D^c$, see (3.29). If we compute scattering amplitudes, we can pass from this propagator to another by adding $k_\mu f_\nu(k) + f_\mu(k) k_\nu$ for an arbitrary function $f_\mu(k)$.

To see this note that after adding $k_\mu f_\nu(k) + f_\mu(k) k_\nu$ the contribution of each line changes by

$$J^\mu(k) (k_\mu f_\nu(k) + f_\mu(k) k_\nu) J^\nu(k),$$

which is zero, because $k_\mu J^\mu(k) = 0$. For scattering amplitudes, external lines do not involve the propagator. Therefore, scattering amplitudes do not change.

Below we will list a number of useful causal propagators. (In principle, they should be decorated by the superscript c , for *causal*, which we however suppress).

For any $\alpha \in \mathbb{R}$, we can pass to the following propagators

$$D_{\mu\nu}^\alpha = \frac{1}{m^2 + k^2 - i0} \left(g_{\mu\nu} + (1 - \alpha) \frac{k_\mu k_\nu}{\alpha k^2 + m^2} \right).$$

The above propagator for $\alpha = 0$ was obtained in the Hamiltonian approach, see (3.29). For $\alpha = 1$ we obtain the so-called propagator in the *Feynman gauge*

$$D_{\mu\nu}^{\text{Feyn}}(k) = \frac{1}{m^2 + k^2 - i0}.$$

$\alpha = \infty$ corresponds to the propagator in the *Landau* or *Lorentz gauge*:

$$D_{\mu\nu}^{\text{Lan}} = \frac{1}{m^2 + k^2 - i0} \left(g_{\mu\nu} - \frac{k_\mu k_\nu}{k^2} \right).$$

We can introduce the propagator in the *Yukawa gauge*:

$$D_{00}^{\text{Yuk}} = -\frac{1}{m^2 + \vec{k}^2}, \quad D_{0j}^{\text{Yuk}} = 0, \quad D_{ij}^{\text{Yuk}} = \frac{1}{m^2 + k^2 - i0} \left(\delta_{ij} - \frac{k_i k_j}{m^2 + \vec{k}^2} \right).$$

We have $D_{\mu\nu}^{\text{Yuk}} = D_{\mu\nu}^{\text{Feyn}} + k_\mu f_\nu^{\text{Yuk}}(k) + f_\mu^{\text{Yuk}}(k) k_\nu$, where

$$f_0^{\text{Yuk}}(k) = \frac{k_0}{(k^2 + m^2 - i0)2(m^2 + \vec{k}^2)}, \quad f_i^{\text{Yuk}}(k) = -\frac{k_i}{(k^2 + m^2 - i0)2(m^2 + \vec{k}^2)}.$$

(The propagator in the Yukawa gauge is the massive analog of the propagator in the Coulomb gauge.)

The propagator in the *temporal gauge* is

$$D_{00}^{\text{tem}} = 0, \quad D_{0j}^{\text{tem}} = 0, \quad D_{ij}^{\text{tem}} = \frac{1}{k^2 + m^2 - i0} \left(\delta_{ij} - \frac{k_i k_j}{k_0^2} \right).$$

We have $D_{\mu\nu}^{\text{tem}} = D_{\mu\nu}^{\text{Feyn}} + k_\mu f_\nu^{\text{tem}}(k) + f_\mu^{\text{tem}}(k) k_\nu$, where

$$f_0^{\text{tem}}(k) = \frac{1}{(m^2 + k^2 - i0)2k_0}, \quad f_i^{\text{tem}}(k) = -\frac{k_i}{(m^2 + k^2 - i0)2k_0^2}.$$

3.2.5 Feynman rules

Perturbation expansion can be organized with help of Feynman diagrams, which are very similar to diagrams for neutral fields interacting with a linear source. We have 1 kind of lines and 1 kind of vertices. At each vertex just one line ends.

To compute Green's functions we do as follows:

- (1) In the n th order we draw all possible Feynman diagrams with n vertices and external lines.
- (2) To each vertex we associate the factor $-iJ^\mu(k)$.
- (3) To each line we associate the propagator $-iD_{\mu\nu}^0(k) = \frac{-i}{m^2 + k^2 - i0} \left(g_{\mu\nu} + \frac{k_\mu k_\nu}{m^2} \right)$.
- (4) For internal lines we integrate over the variables with the measure $\frac{d^4 k}{(2\pi)^4}$.

To compute scattering amplitudes with N^- incoming and N^+ outgoing particles we draw the same diagrams as for $N^- + N^+$ -point Green's functions. The rules are changed only concerning the external lines.

- (i) With each incoming external line we associate $\frac{1}{\sqrt{(2\pi)^3 2\varepsilon(\vec{k})}} u(k, \sigma)$.
- (ii) With each outgoing external line we associate $\frac{1}{\sqrt{(2\pi)^3 2\varepsilon(\vec{k})}} \bar{u}(k, \sigma)$.

If we prefer, we can use a different causal propagator instead of $D_{\mu\nu}^0$. Green's functions change, because of external lines, however scattering amplitudes do not.

3.2.6 Path integral formulation

We can compute exactly the generating function:

$$\begin{aligned} Z(f) & \tag{3.43} \\ &= \exp \left(\frac{i}{2} \int \frac{1}{J^\mu(k) + f^\mu(k)} \frac{(g_{\mu\nu} + m^{-2} k_\mu k_\nu)}{(k^2 + m^2 - i0)} (J^\nu(k) + f^\nu(k)) dk \right). \end{aligned}$$

This can be rewritten in the path integral formalism. Recall that

$$\begin{aligned}
\int \mathcal{L}_{\text{fr}}(x) dx &= - \int \frac{1}{2} \left(\partial_\mu A_\nu(x) \partial^\mu A^\nu(x) - \partial_\mu A_\nu(x) \partial^\nu A^\mu(x) \right. \\
&\quad \left. + m^2 A_\mu(x) A^\mu(x) \right) dx \\
&= - \int \frac{1}{2} A_\mu(x) (g^{\mu\nu} (-\square + m^2) + \partial^\mu \partial^\nu) A_\nu(x) dx, \\
\int (\mathcal{L}(x) - f^\mu(x) A_\mu(x)) dx &= \int \mathcal{L}_{\text{fr}}(x) dx - \int (J^\mu + f^\mu(x)) A_\mu(x) dx.
\end{aligned}$$

Note that $D_{\mu\nu}^0(k) = \frac{g_{\mu\nu} + m^{-2} k_\mu k_\nu}{k^2 + m^2 - i0}$, or in the position representation $D_{\mu\nu}^0 = (g_{\mu\nu} - m^{-2} \partial_\mu \partial_\nu) D^c$ is one of the inverses of $g^{\mu\nu} (-\square + m^2) + \partial^\mu \partial^\nu$. Therefore, (3.43) is often formally rewritten as

$$Z(f) = \frac{\int \prod_{\mu} \prod_x dA_\mu(x) \exp(i \int (\mathcal{L}(x) - (J^\mu(x) + f^\mu(x)) A_\mu(x)) dx)}{\int \prod_{\mu} \prod_x dA_\mu(x) \exp(i \int \mathcal{L}_{\text{fr}}(x) dx)}.$$

Let $D_{\mu\nu}^\bullet$ be one of the propagators considered in Subsect. 3.2.4. Let $B_{\bullet}^{\mu\nu}$ be its inverse. We have the corresponding ‘‘free action’’

$$T_{\bullet\text{fr}} = -\frac{1}{2} \int A_\mu(x) B_{\bullet}^{\mu\nu}(x-y) A_\nu(y) dx dy.$$

We define the corresponding generating function as

$$\begin{aligned}
Z_{\bullet}(f) & \tag{3.44} \\
& := \exp\left(\frac{i}{2} \int \overline{(J^\mu(k) + f^\mu(k))} D_{\bullet\mu\nu}(k) (J^\nu(k) + f^\nu(k)) dk\right) \\
& = \exp\left(\frac{i}{2} \int (J^\mu(x) + f^\mu(x)) D_{\bullet\mu\nu}(x-y) (J^\nu(y) + f^\nu(y)) dx dy\right) \\
& = \frac{\int \prod_{\mu} \prod_x dA_\mu(x) \exp(i T_{\bullet\text{fr}} + i \int (J^\mu(x) + f^\mu(x)) A_\mu(x) dx)}{\int \prod_{\mu} \prod_x dA_\mu(x) \exp(i T_{\bullet\text{fr}})}.
\end{aligned}$$

In general, $Z_{\bullet}(f)$ differs for various propagators $D_{\mu\nu}^\bullet$, unless f satisfies the Lorentz condition. However, all $Z_{\bullet}(f)$ can be used to compute the same scattering operator.

Likewise, the Euler-Lagrange equations obtained from those various action integrals differ from the Proca equation. However, \mathcal{Y}_{Pr} belong always to their solutions.

If we take the Lagrangian

$$\begin{aligned}
& -\frac{1}{2} \left(\partial_\mu A^\nu(x) \partial^\mu A_\nu(x) + m^2 A^\nu(x) A_\nu(x) \right. \\
& \left. + (\alpha - 1) \partial_\mu A^\mu(x) \partial_\nu A^\nu(x) \right), \tag{3.45}
\end{aligned}$$

then we obtain the propagator $D_{\mu\nu}^\alpha$. Indeed,

$$g^{\mu\nu}(k^2 + m^2) + (\alpha - 1)k^\mu k^\nu$$

is the inverse of $D_{\mu\nu}^\alpha(k)$.

If we restrict the integration by the Lorentz condition

$$\partial_\mu A^\mu(x) = 0. \quad (3.46)$$

and take the Lagrangian (3.45) (they now coincide for all α), then we obtain the propagator in the Landau/Lorentz gauge.

If we take the Lagrangian

$$\begin{aligned} & -\frac{1}{2} \left(\partial_\mu A_i(x) \partial^\mu A_i(x) + m^2 A_i(x) A_i(x) \right. \\ & + \frac{1}{m^2} \partial_\mu \partial_i A_i(x) \partial^\mu \partial_j A_j(x) + \partial_i A_i(x) \partial_j A_j(x) \\ & \left. - \partial_i A_0(x) \partial_i A_0(x) - m^2 A_0(x)^2 \right), \end{aligned}$$

we obtain $D_{\mu\nu}^{\text{Yuk}}$. Indeed,

$$(k^2 + m^2) \left(\delta_{ij} + \frac{k_i k_j}{m^2} \right) - \delta_{\mu 0} \delta_{0\nu} (\vec{k}^2 + m^2)$$

is the inverse of $D_{\mu\nu}^{\text{Yuk}}(k)$.

If we take the action

$$\begin{aligned} & -\frac{1}{2} \int (\partial_\mu A_i(x) \partial^\mu A_i(x) + m^2 A_i(x) A_i(x)) dx \\ & -\frac{1}{2} \int \left(\partial_\mu \partial_i A_i(x) (-\square)^{-1}(x-y) \partial^\mu \partial_j A_j(y) \right. \\ & \left. + \partial_i A_i(x) (-\square)^{-1}(x-y) \partial_j A_j(y) \right) dx dy, \end{aligned}$$

(which is nonlocal and does not involve A_0), we obtain $D_{\mu\nu}^{\text{tem}}$. Indeed,

$$(k^2 + m^2) \left(\delta_{ij} - \frac{k_i k_j}{k^2} \right)$$

is the inverse of $D_{ij}^{\text{tem}}(k)$.

3.2.7 Energy shift

Suppose that the 4-current is stationary and is given by a Schwartz function $\mathbb{R}^3 \ni \vec{x} \mapsto J^\mu(\vec{x})$. Note that $\text{div} \vec{J}(\vec{x}) = 0$.

Using the quantum version of (3.41), we can write the Hamiltonian as

$$\begin{aligned}\hat{H} &= \int d\vec{x} : \left(\frac{1}{2} \vec{E}_{\text{tr}}^2(\vec{x}) + \frac{1}{2} \vec{A}_{\text{tr}}(\vec{x}) (-\Delta + m^2) \vec{A}_{\text{tr}}(\vec{x}) + \vec{J}(\vec{x}) \vec{A}_{\text{tr}}(\vec{x}) \right) : \\ &+ \int d\vec{x} : \left(\frac{1}{2} ((-\Delta)^{-1/2} \text{div} \vec{E}(\vec{x}))^2 + \frac{1}{2m^2} (J^0(\vec{x}) - \text{div} \vec{E}(\vec{x}))^2 \right. \\ &\quad \left. + \frac{m^2}{2} ((-\Delta)^{-1/2} \text{div} \vec{A}(\vec{x}))^2 \right) :.\end{aligned}$$

By (A.14), the infimum of \hat{H} is

$$\begin{aligned}E &= -\frac{1}{2} \int \int d\vec{x} d\vec{y} \vec{J}(\vec{x}) \frac{e^{-m|\vec{x}-\vec{y}|}}{4\pi|\vec{x}-\vec{y}|} \vec{J}(\vec{y}) \\ &\quad + \frac{1}{2} \int \int d\vec{x} d\vec{y} J^0(\vec{x}) \frac{e^{-m|\vec{x}-\vec{y}|}}{4\pi|\vec{x}-\vec{y}|} J^0(\vec{y}).\end{aligned}$$

3.3 Alternative approaches

3.3.1 Classical 4-potentials without the Lorentz condition

So far our treatment of massive photons was based on the Proca equation (3.1). As we remember, the Proca equation is equivalent to the Klein-Gordon equation for vector fields (3.8) together with the Lorentz condition (3.9). This suggests an alternative approach to the massive photons.

In this approach one considers first the Klein-Gordon equation on functions with values in $\mathbb{R}^{1,3}$:

$$(-\square + m^2)\zeta_\mu(x) = 0. \quad (3.47)$$

The space of smooth real space-compact solutions of (3.47) will be denoted by \mathcal{Y}_{vec} . The following 4-current

$$j_{\text{vec}}^\mu(\zeta_1, \zeta_2, x) := \partial^\mu \zeta_{1,\nu}(x) \zeta_2^\nu(x) - \zeta_{1,\nu}(x) \partial^\mu \zeta_2^\nu(x)$$

is conserved, that is

$$\partial_\mu j_{\text{vec}}^\mu(x) = 0.$$

It defines in the usual way a symplectic form on \mathcal{Y}_{vec}

$$\begin{aligned}\zeta_1 \omega_{\text{vec}} \zeta_2 &= \int_{\mathcal{S}} j_{\text{vec}}^\mu(\zeta_1, \zeta_2, x) ds_\mu(x) \\ &= \int \left(-\dot{\zeta}_{1\nu}(t, \vec{x}) \zeta_2^\nu(t, \vec{x}) + \zeta_{1\nu}(t, \vec{x}) \dot{\zeta}_2^\nu(t, \vec{x}) \right) d\vec{x},\end{aligned}$$

where \mathcal{S} is any Cauchy surface.

One introduces the 4-potentials $A^\mu(x)$ as the functionals on \mathcal{Y}_{vec} defined by

$$\langle A^\mu(x) | \zeta \rangle := \zeta^\mu(x).$$

We clearly have

$$(-\square + m^2)A_\mu(x) = 0. \quad (3.48)$$

We can use the Lagrangian

$$\mathcal{L}(x) := -\frac{1}{2}A_{\mu,\nu}(x)A^{\mu,\nu}(x) - \frac{m^2}{2}A_\mu(x)A^\mu(x).$$

The conjugate variables are

$$\Pi_\mu(x) := \frac{\partial}{\partial \dot{A}^\mu(x)} \mathcal{L}(x) = \dot{A}_\mu(x).$$

The Poisson structure is given by the equal time brackets

$$\begin{aligned} \{A_\mu(t, \vec{x}), A_\nu(t, \vec{y})\} &= \{\Pi_\mu(t, \vec{x}), \Pi_\nu(t, \vec{y})\} = 0, \\ \{A_\mu(t, \vec{x}), \Pi_\nu(t, \vec{y})\} &= g_{\mu\nu} \delta(\vec{x} - \vec{y}). \end{aligned}$$

The stress-energy tensor is

$$\begin{aligned} \mathcal{T}^{\mu\nu} &= -\frac{\partial \mathcal{L}}{\partial A_{\alpha,\mu}} A_\alpha{}^\nu + g^{\mu\nu} \mathcal{L} \\ &= A_\alpha{}^\mu A^{\alpha,\nu} - \frac{1}{2} g^{\mu\nu} (A_{\alpha,\beta} A^{\alpha,\beta} + m^2 A_\alpha A^\alpha). \end{aligned}$$

The Hamiltonian and momentum density are

$$\begin{aligned} \mathcal{H}(x) = \mathcal{T}^{00}(x) &= \frac{1}{2} \Pi_\mu(x) \Pi^\mu(x) + \frac{1}{2} A_{\mu,i}(x) A^{\mu,i}(x) + \frac{m^2}{2} A_\mu(x) A^\mu(x), \\ \mathcal{P}^i(x) = \mathcal{T}^{0i}(x) &= -\Pi_\mu(x) A^{\mu,i}(x). \end{aligned}$$

As usual, we can define the Hamiltonian and momentum

$$\begin{aligned} H &= \int \mathcal{H}(t, \vec{x}) d\vec{x}, \\ P^j &= \int \mathcal{P}^j(t, \vec{x}) d\vec{x}. \end{aligned} \quad (3.49)$$

The Hamiltonian (3.49) is unbounded from below.

3.3.2 The Lorentz condition

Introduce two subspaces of \mathcal{Y}_{vec}

$$\begin{aligned} \mathcal{Y}_{\text{Lor}} &:= \{\zeta \in \mathcal{Y}_{\text{vec}} : \partial_\mu \zeta^\mu = 0\}, \\ \mathcal{Y}_{\text{sc}} &:= \{\zeta \in \mathcal{Y}_{\text{vec}} : \zeta^\mu = \partial^\mu \chi, \chi \in \mathcal{Y}_{\text{KG}}\}. \end{aligned}$$

Note that $\mathcal{Y}_{\text{vec}} = \mathcal{Y}_{\text{Lor}} \oplus \mathcal{Y}_{\text{sc}}$ is a decomposition into symplectically orthogonal subspaces each preserved by the Poincaré group. If $\zeta \in \mathcal{Y}_{\text{vec}}$, then its projection onto \mathcal{Y}_{sc} is

$$\zeta_{\text{sc}}^\mu := \frac{1}{m^2} \partial^\mu \partial_\nu \zeta^\nu. \quad (3.50)$$

Elements of \mathcal{Y}_{Lor} satisfy the Proca equation, so that we can make the identification

$$\mathcal{Y}_{\text{Lor}} = \mathcal{Y}_{\text{Pr}}.$$

On \mathcal{Y}_{Lor} the forms ω_{vec} and ω_{Pr} coincide.

Clearly, we are back with the theory that was used in most of this section. In particular, the Hamiltonian (3.49) restricted to \mathcal{Y}_{Lor} is now positive.

3.3.3 Diagonalization of the equations of motion

In order to diagonalize the Hamiltonian, besides the vectors $u(k, \sigma)$ with $\sigma = 0, \pm 1$ introduced in (3.22), we will need the vectors for the scalar plane waves

$$u(k, \text{sc}) := \frac{1}{m}(\varepsilon(\vec{k}), \vec{k}).$$

Note that

$$\begin{aligned} \overline{u_\mu(k, \sigma)} u^\mu(k, \sigma') &= \delta_{\sigma, \sigma'}, \\ \sum_\sigma \overline{u_\mu(k, \sigma)} u_\nu(k, \sigma) &= g_{\mu\nu}. \end{aligned}$$

Set

$$\begin{aligned} \vec{A}_t(\vec{k}) &= \int \vec{A}(t, \vec{x}) e^{-i\vec{k}\cdot\vec{x}} \frac{d\vec{x}}{\sqrt{(2\pi)^3}}, \\ \vec{\Pi}_t(\vec{k}) &= \int \vec{\Pi}(t, \vec{x}) e^{-i\vec{k}\cdot\vec{x}} \frac{d\vec{x}}{\sqrt{(2\pi)^3}}. \end{aligned}$$

We have the equations of motion

$$\begin{aligned} \dot{A}_t(\vec{k}) &= \Pi_t(\vec{k}), \\ \dot{\Pi}_t(\vec{k}) &= -\varepsilon(\vec{k})^2 A_t(\vec{k}), \end{aligned}$$

the relations

$$A_t^*(\vec{k}) = A_t(-\vec{k}), \quad \Pi_t^*(\vec{k}) = \Pi_t(-\vec{k}),$$

and the Poisson brackets

$$\begin{aligned} \{A_{t\mu}^*(\vec{k}), A_{t\nu}(\vec{k}')\} &= \{\Pi_{t\mu}^*(\vec{k}), \Pi_{t\nu}(\vec{k}')\} = 0, \\ \{A_{t\nu}^*(\vec{k}'), \Pi_{t\mu}(\vec{k})\} &= g_{\mu\nu} \delta(\vec{k} - \vec{k}'). \end{aligned} \quad (3.51)$$

Set

$$\begin{aligned} A_t(\vec{k}, \sigma) &:= \overline{u_\mu(\vec{k}, \sigma)} A_t^\mu(\vec{k}), \\ \Pi_t(\vec{k}, \sigma) &:= \overline{u_\mu(\vec{k}, \sigma)} \Pi_t^\mu(\vec{k}). \end{aligned}$$

We have the equations of motion

$$\begin{aligned}\dot{A}_t(\vec{k}, \sigma) &= \Pi_t(\vec{k}, \sigma), \\ \dot{\Pi}_t(\vec{k}, \sigma) &= -\varepsilon(\vec{k})^2 A_t(\vec{k}, \sigma),\end{aligned}$$

the relations

$$A_t^*(\vec{k}, \sigma) = A_t(-\vec{k}, -\sigma), \quad \Pi_t^*(\vec{k}, \sigma) = \Pi_t(-\vec{k}, -\sigma),$$

and the Poisson brackets

$$\begin{aligned}\{A_t^*(\vec{k}, \sigma), A_t(\vec{k}', \sigma')\} &= \{\Pi_t^*(\vec{k}, \sigma), \Pi_t(\vec{k}', \sigma')\} = 0, \\ \{A_t^*(\vec{k}, \sigma), \Pi_t(\vec{k}', \sigma')\} &= \kappa_{\sigma\sigma'} \delta(\vec{k} - \vec{k}').\end{aligned}\quad (3.52)$$

where $\kappa_{\sigma,\sigma'} = 1$ for $\sigma = \sigma' = \pm 1, 0$ and $\kappa_{\text{sc},\text{sc}} = -1$. We set

$$\begin{aligned}a_t(k, \sigma) &:= \sqrt{\frac{\varepsilon(\vec{k})}{2}} A_t(\vec{k}, \sigma) - \frac{\text{i}}{\sqrt{2\varepsilon(\vec{k})}} \Pi_t(\vec{k}, \sigma), \\ a_t^*(k, \sigma) &:= \sqrt{\frac{\varepsilon(\vec{k})}{2}} A_t^*(\vec{k}, \sigma) + \frac{\text{i}}{\sqrt{2\varepsilon(\vec{k})}} \Pi_t^*(\vec{k}, \sigma).\end{aligned}$$

We have the equations of motion

$$\begin{aligned}\dot{a}_t(k, \sigma) &= -\text{i}\varepsilon(\vec{k}) a_t(k, \sigma), \\ \dot{a}_t^*(k, \sigma) &= \text{i}\varepsilon(\vec{k}) a_t^*(k, \sigma).\end{aligned}$$

and the Poisson brackets

$$\begin{aligned}\{a(k, \sigma), a(k', \sigma')\} &= \{a^*(k, \sigma), a^*(k', \sigma')\} = 0, \\ \{a(k, \sigma), a^*(k', \sigma')\} &= -\text{i}\kappa_{\sigma,\sigma'} \delta(\vec{k} - \vec{k}').\end{aligned}$$

We diagonalize the Hamiltonian and momentum:

$$\begin{aligned}H &= \sum_{\sigma=0,\pm 1} \int d\vec{k} \varepsilon(\vec{k}) a^*(k, \sigma) a(k, \sigma) - \int d\vec{k} \varepsilon(\vec{k}) a^*(k, \text{sc}) a(k, \text{sc}), \\ \vec{P} &= \sum_{\sigma=0,\pm 1} \int d\vec{k} \vec{k} a^*(k, \sigma) a(k, \sigma) - \int d\vec{k} \vec{k} a^*(k, \text{sc}) a(k, \text{sc}).\end{aligned}$$

The 4-potentials can be decomposed as

$$A_\mu(x) = \sum_\sigma \int \frac{d\vec{k}}{\sqrt{(2\pi)^3} \sqrt{2\varepsilon(\vec{k})}} \left(u_\mu(k, \sigma) e^{\text{i}kx} a(k, \sigma) + \overline{u_\mu(k, \sigma)} e^{-\text{i}kx} a^*(k, \sigma) \right).$$

Clearly, the restriction to \mathcal{Y}_{Lor} amounts to dropping all scalar components.

3.3.4 Positive frequency space

$\mathcal{W}_{\text{vec}}^{(+)}$ will denote the subspace of $\mathbb{C}\mathcal{Y}_{\text{vec}}$ consisting of *positive frequency solutions*:

$$\mathcal{W}_{\text{vec}}^{(+)} := \{g \in \mathbb{C}\mathcal{Y}_{\text{Pr}} : \overline{(k, \sigma)} \omega_{\text{vec}} g = 0, \sigma = \pm, 0, \text{sc}\}.$$

Every $g \in \mathcal{W}_{\text{vec}}^{(+)}$ can be written as

$$g_{\mu}(x) = \sum_{\sigma=0, \pm 1, \text{sc}} \int \frac{d\vec{k}}{\sqrt{(2\pi)^3} \sqrt{2\varepsilon(\vec{k})}} e^{ikx} u_{\mu}(k, \sigma) \langle a(k, \sigma) | g \rangle.$$

For $g_1, g_2 \in \mathcal{W}_{\text{vec}}^{(+)}$ we have a natural scalar product

$$\begin{aligned} (g_1 | g_2) &:= i\bar{g}_1 \omega_{\text{vec}} g_2 = \sum_{\sigma=0, \pm 1} \int \overline{\langle a(k, \sigma) | g_1 \rangle} \langle a(k, \sigma) | g_2 \rangle d\vec{k} \\ &\quad - \int \overline{\langle a(k, \text{sc}) | g_1 \rangle} \langle a(k, \text{sc}) | g_2 \rangle d\vec{k} \\ &= \int g^{\mu\nu} \overline{\langle a_{\mu}(k) | g_1 \rangle} \langle a_{\nu}(k) | g_2 \rangle d\vec{k}. \end{aligned} \quad (3.53)$$

Unfortunately, the above definition gives an indefinite scalar product. We can also introduce a positive definite scalar product, which unfortunately is not covariant:

$$(g_1 | g_2)_+ := \sum_{\mu} \int \overline{\langle a_{\mu}(k) | g_1 \rangle} \langle a_{\mu}(k) | g_2 \rangle d\vec{k}.$$

The positive frequency space $\mathcal{W}_{\text{vec}}^{(+)}$ equipped with the scalar product (3.53) can be completed in the norm given by $(\cdot | \cdot)_+$. It will be called \mathcal{Z}_{vec} . It is an example of the so-called *Krein space*, which is a space with an indefinite scalar product and has a topology given by a positive scalar product.

Using the projection (3.50), $\mathcal{W}_{\text{vec}}^{(+)}$ can be decomposed into the direct sum of orthogonal subspaces $\mathcal{W}_{\text{Lor}}^{(+)}$ and $\mathcal{W}_{\text{sc}}^{(+)}$. On $\mathcal{W}_{\text{Lor}}^{(+)}$ the scalar product (3.53) is positive definite, on $\mathcal{W}_{\text{sc}}^{(+)}$ it is negative definite. Their completions will be denoted \mathcal{Z}_{Lor} and \mathcal{Z}_{sc} .

Every $\zeta \in \mathcal{Y}_{\text{vec}}$ can be uniquely written as $\zeta = \zeta^{(+)} + \overline{\zeta^{(+)}}$, where $\zeta^{(+)} \in \mathcal{W}_{\text{vec}}^{(+)}$. This allows us to define a real scalar product on \mathcal{Y}_{vec} :

$$\begin{aligned} \langle \zeta_1 | \zeta_2 \rangle_{\mathcal{Y}} &:= \text{Re}(\zeta_1^{(+)} | \zeta_2^{(+)}) \\ &= \int \int \dot{\zeta}_{1\mu}(0, \vec{x}) (-i) D^{(+)}(0, \vec{x} - \vec{y}) \dot{\zeta}_2^{\mu}(0, \vec{y}) d\vec{x} d\vec{y} \\ &\quad + \int \int \zeta_{1\mu}(0, \vec{x}) (-\Delta_{\vec{x}} + m^2) (-i) D^{(+)}(0, \vec{x} - \vec{y}) \zeta_2^{\mu}(0, \vec{y}) d\vec{x} d\vec{y}. \end{aligned} \quad (3.54)$$

Again, (3.54) is positive definite on \mathcal{Y}_{Lor} and negative definite on \mathcal{Y}_{sc} .

3.3.5 “First quantize, then reduce”

The quantization described in Subsect. 3.1 will be called “*first reduce, then quantize*”. There exist alternative methods of quantization, which use the symplectic space \mathcal{Y}_{vec} introduced in (3.47) as the basis. There are two basic ways to implement this idea.

The first insists on using only *positive definite Hilbert spaces*. Unfortunately, the Hamiltonian turns out to be unbounded from below.

In the *Gupta-Bleuler approach* the 4-potentials $\hat{A}^\mu(x)$ evolve with positive frequencies. Unfortunately, it uses an indefinite scalar product.

3.3.6 Quantization without reduction on a positive definite Hilbert space

In this approach we use the Hilbert space

$$\Gamma_{\text{s}}(\mathcal{Z}_{\text{Lor}} \oplus \overline{\mathcal{Z}}_{\text{sc}}) \quad (3.55)$$

equipped with a positive definite scalar product. More explicitly, we replace $a(k, \sigma)$ with $\hat{a}(k, \sigma)$ for $\sigma = 0, \pm 1$. We replace $a(k, \text{sc})$ with $\hat{b}^*(k, \text{sc})$. They satisfy the standard commutation relations

$$\begin{aligned} [\hat{a}(k, \sigma), \hat{a}^*(k', \sigma')] &= \delta_{\sigma, \sigma'} \delta(\vec{k} - \vec{k}'), \\ [\hat{b}(k, \text{sc}), \hat{b}^*(k', \text{sc})] &= \delta(\vec{k} - \vec{k}'). \end{aligned}$$

$\hat{a}(k, \sigma)$, $\hat{b}(k, \text{sc})$ kill the vacuum:

$$\hat{a}(k, \sigma)\Omega = \hat{b}(k, \text{sc})\Omega = 0.$$

The quantized 4-potentials, Hamiltonian and momentum become

$$\begin{aligned} \hat{A}_\mu(x) &= \sum_{\sigma=0, \pm 1} \int \frac{d\vec{k}}{\sqrt{(2\pi)^3} \sqrt{2\varepsilon(\vec{k})}} \left(u_\mu(k, \sigma) e^{ikx} \hat{a}(k, \sigma) + \overline{u_\mu(k, \sigma)} e^{-ikx} \hat{a}^*(k, \sigma) \right) \\ &\quad + \int \frac{d\vec{k}}{\sqrt{(2\pi)^3} \sqrt{2\varepsilon(\vec{k})}} \left(u_\mu(k, \text{sc}) e^{ikx} \hat{b}^*(k, \text{sc}) + \overline{u_\mu(k, \text{sc})} e^{-ikx} \hat{b}(k, \text{sc}) \right), \\ \hat{H} &= \sum_{\sigma=0, \pm 1} \int d\vec{k} \varepsilon(\vec{k}) \hat{a}^*(k, \sigma) \hat{a}(k, \sigma) - \int d\vec{k} \varepsilon(\vec{k}) \hat{b}^*(k, \text{sc}) \hat{b}(k, \text{sc}), \\ \hat{P} &= \sum_{\sigma=0, \pm 1} \int d\vec{k} \vec{k} \hat{a}^*(k, \sigma) \hat{a}(k, \sigma) - \int d\vec{k} \vec{k} \hat{b}^*(k, \text{sc}) \hat{b}(k, \text{sc}). \end{aligned}$$

The propagator in the position representation is given by

$$\left(\Omega | \text{T}(\hat{A}_\mu(x) \hat{A}_\nu(y)) \Omega \right) = -i \left(g_{\mu\nu} - \frac{2}{m^2} \partial_\mu \partial_\nu \right) D^c(x - y),$$

and in the momentum representation

$$\frac{-i}{k^2 + m^2 - i0} \left(g_{\mu\nu} + 2 \frac{k_\mu k_\nu}{m^2} \right).$$

It is an example of a propagator from the class considered in Subsubsection. 3.2.4. Note also that

$$(\Omega | \hat{A}((\zeta))^2 \Omega) = \langle \zeta | \zeta \rangle_{\mathcal{Y}} + \frac{2}{m^2} \langle \partial_\mu \zeta^\mu | \partial_\nu \zeta^\nu \rangle_{\mathcal{Y}}, \quad (3.56)$$

which is the scalar product (3.54) corrected by a term given by the scalar product (2.37). Note that (3.56) is positive definite.

Vectors built by applying fields satisfying the Lorentz condition to the vacuum will be called *physical*. Equivalently, physical vectors are elements of the algebraic Fock space built on $\mathcal{W}_{\text{Lor}}^{(+)}$. After the completion the physical space coincides with $\Gamma_s(\mathcal{Z}_{\text{Lor}})$. Thus we obtain the same space as in the method “first reduce, then quantize”.

It will be convenient to describe this method in the C^* -algebraic language. Let $\text{CCR}(\mathcal{Y}_{\text{vec}})$ denote the (Weyl) C^* -algebra of the CCR over \mathcal{Y}_{vec} , that is, the C^* -algebra generated by $W(\zeta)$, $\zeta \in \mathcal{Y}_{\text{vec}}$, such that

$$W(\zeta_1)W(\zeta_2) = e^{-i \frac{\zeta_1 \omega_{\text{vec}} \zeta_2}{2}} W(\zeta_1 + \zeta_2), \quad W(\zeta)^* = W(-\zeta). \quad (3.57)$$

We have the obvious action of $\mathbb{R}^{1,3} \rtimes O^\uparrow(1,3)$ on $\text{CCR}(\mathcal{Y}_{\text{vec}})$ by $*$ -automorphisms:

$$\hat{r}_{(y,\Lambda)}(W(\zeta)) := W(r_{(y,\Lambda)}(\zeta)).$$

Choose the state on $\text{CCR}(\mathcal{Y}_{\text{vec}})$ defined by

$$\begin{aligned} \psi(W(\zeta)) & \\ = \exp \left(-\frac{1}{2} \langle \zeta | \zeta \rangle_{\mathcal{Y}} - \frac{1}{m^2} \langle \partial_\mu \zeta^\mu | \partial_\nu \zeta^\nu \rangle_{\mathcal{Y}} \right) & \end{aligned} \quad (3.58)$$

Let $(\mathcal{H}_\psi, \pi_\psi, \Omega_\psi)$ be the GNS representation generated by the state ψ . Using (3.56) we see that \mathcal{H}_ψ can be identified with $\Gamma_s(\mathcal{Z}_{\text{Lor}} \oplus \overline{\mathcal{Z}}_{\text{sc}})$ and the fields are related to the Weyl operators by

$$\pi_\psi(W(\zeta)) = e^{i\hat{A}((\zeta))}.$$

3.3.7 The Gupta-Bleuler approach

This approach also uses the symplectic space \mathcal{Y}_{vec} as the basic input. It follows almost verbatim the usual steps of quantization of the Klein-Gordon equation. We introduce the bosonic Fock space $\Gamma_s(\mathcal{Z}_{\text{vec}})$, which has an indefinite scalar product and can be viewed as a Krein space.

We replace $a(k, \sigma)$ by $\hat{a}(k, \sigma)$. The commutation relations have a wrong sign for the scalar component:

$$[\hat{a}(k, \sigma), \hat{a}^*(k', \sigma')] = \kappa_{\sigma, \sigma'} \delta(\vec{k} - \vec{k}').$$

The annihilation operators kill the vacuum:

$$\hat{a}(k, \sigma)\Omega = 0.$$

The expressions for the Hamiltonian, momentum and 4-potentials are the same as in the classical case:

$$\begin{aligned}\hat{H} &= \sum_{\sigma=0,\pm 1} \int d\vec{k} \varepsilon(\vec{k}) \hat{a}^*(k, \sigma) \hat{a}(k, \sigma) - \int d\vec{k} \varepsilon(\vec{k}) \hat{a}^*(k, \text{sc}) \hat{a}(k, \text{sc}), \\ \vec{\hat{P}} &= \sum_{\sigma=0,\pm 1} \int d\vec{k} \vec{k} \hat{a}^*(k, \sigma) \hat{a}(k, \sigma) - \int d\vec{k} \vec{k} \hat{a}^*(k, \text{sc}) \hat{a}(k, \text{sc}).\end{aligned}$$

$$\hat{A}_\mu(x) = \sum_\sigma \int \frac{d\vec{k}}{\sqrt{(2\pi)^3} \sqrt{2\varepsilon(\vec{k})}} \left(u_\mu(k, \sigma) e^{ikx} \hat{a}(k, \sigma) + \overline{u_\mu(k, \sigma)} e^{-ikx} \hat{a}^*(k, \sigma) \right).$$

Note that all eigenvalues of \hat{H} are positive, however its expectation values (wrt the indefinite scalar product) can be negative. We have

$$\begin{aligned}(\Omega | \hat{A}_\mu(x) \hat{A}_\nu(y) \Omega) &= -ig_{\mu\nu} D^{(+)}(x-y), \\ (\Omega | \text{T}(\hat{A}_\mu(x) \hat{A}_\nu(y)) \Omega) &= -ig_{\mu\nu} D^c(x-y).\end{aligned}$$

In particular, the 2-point Green's function is the propagator in the Feynman gauge. Smeared 4-potentials $\hat{A}((g))$ are well defined operators.

Similarly as in the previous method, vectors created by applying fields satisfying the Lorentz condition to the vacuum will be called *physical*. Again we obtain the algebraic Fock space built on $\mathcal{W}_{\text{Lor}}^{(+)}$. This space is positive definite and after the completion coincides with $\Gamma_s(\mathcal{Z}_{\text{Lor}})$. Thus the physical space is the same as before.

4 Massless photons

In this section we discuss the quantization of the *Maxwell equation*

$$-\partial_\mu F^{\mu\nu}(x) = 0, \tag{4.1}$$

where, as in the previous section,

$$F^{\mu\nu} := \partial^\mu A^\nu - \partial^\nu A^\mu.$$

We will also consider an external *conserved 4-current*, that is a vector function $J^\nu(x)$ satisfying

$$\partial_\nu J^\nu(x) = 0. \tag{4.2}$$

The Maxwell equation in the presence of the current J reads

$$\partial_\mu F^{\mu\nu}(x) = J^\nu(x). \tag{4.3}$$

Similarly as in the massive case, there are several possible approaches to the Maxwell equation on the classical and, especially, quantum level. The approach based from the beginning on the reduced phase space, both for the classical description and quantization, will be treated as the standard one. The situation is however somewhat more complicated than in the massive case, since the Lorentz condition is not enough to fully reduce the phase space. Alternative approaches will be discussed later.

We try to make the discussion of massive and massless photons as parallel as possible. This is not entirely straightforward. In particular, the massless limit is quite subtle – to describe it one needs to fix the time coordinate. The covariant 4-potential converges as $m \searrow 0$ in an appropriate sense to the noncovariant 4-potential in the Coulomb gauge.

4.1 Free massless photons

4.1.1 Space of solutions and the gauge invariance

It is well known that the Maxwell equation

$$-\partial_\mu(\partial^\mu\zeta^\nu(x) - \partial^\nu\zeta^\mu(x)) = 0 \quad (4.4)$$

is invariant w.r.t. the replacement of ζ_μ with $\zeta_\mu + \partial_\mu\chi$, where χ is an arbitrary smooth function on the space-time. In particular, there is no uniqueness of the Cauchy problem for (4.4).

This property is called *gauge invariance*. It poses problems both for the classical and quantum theory. One could avoid the problem of gauge invariance by considering fields and not 4-potentials as basic objects. However, when one quantizes the Maxwell equation with a 4-current, it is more convenient to use 4-potentials. Therefore, we will stick to 4-potentials.

There exist several ways to cope with gauge invariance. The approach that we will use as the standard one can be called *first reduce, then quantize*. In this approach we start with the Maxwell equation in the form (4.4). Note that it coincides with the Proca equation with $m = 0$. We will use objects defined in the context of the Proca equation, where we replace Pr with Max to indicate that the mass is zero.

Thus the space of smooth space compact solutions of (4.4) is denoted $\mathcal{Y}_{\widetilde{\text{Max}}}$ and (3.6) defines a conserved 4-current, which we now call $j_{\widetilde{\text{Max}}}$, that leads to the form defined as in (3.7):

$$\begin{aligned} & \zeta_1 \omega_{\widetilde{\text{Max}}} \zeta_2 \\ = & \int \left(- \left(\dot{\zeta}_1(t, \vec{x}) - \vec{\partial} \zeta_{10}(t, \vec{x}) \right) \vec{\zeta}_2(t, \vec{x}) + \vec{\zeta}_1(t, \vec{x}) \left(\dot{\zeta}_2(t, \vec{x}) - \vec{\partial} \zeta_{20}(t, \vec{x}) \right) \right) d\vec{x}. \end{aligned} \quad (4.5)$$

Unfortunately, this form is only *presymplectic* not symplectic (it is degenerate).

(4.5) does not depend on the gauge. To see this it is enough to note that if $\zeta_2 = \partial\chi$, and ζ_1 is a solution of the Maxwell equation, then the integrand of (4.5) is a spatial divergence, so (4.5) is then zero.

We say that a solution ζ of the Maxwell equation is in the *Coulomb gauge* if

$$\zeta_0 = 0, \quad \operatorname{div} \vec{\zeta} = 0.$$

A function in $C^\infty(\mathbb{R}^3, \mathbb{R}^3)$ will be called *transversal* if its divergence vanishes.

Note that every $\zeta \in \mathcal{Y}_{\widetilde{\text{Max}}}$ is gauge-equivalent to a unique solution of the Maxwell equation in the Coulomb gauge, denoted by ζ^{Coul} , where

$$\chi(t, \vec{x}) = -(-\Delta)^{-1} \operatorname{div} \vec{\zeta}(t, \vec{x}), \quad \zeta_\mu^{\text{Coul}} + \partial_\mu \chi = \zeta_\mu. \quad (4.6)$$

Neither χ nor ζ^{Coul} have to be space-compact. The Stokes theorem yields however that $\int \operatorname{div} \vec{\zeta}(t, \vec{x}) d\vec{x} = 0$, therefore χ and ζ^{Coul} behave like $O(|\vec{x}|^{-2})$ because of (A.39).

The presymplectic form can be written as

$$\begin{aligned} \zeta_1 \omega_{\widetilde{\text{Max}}} \zeta_2 &= \zeta_1^{\text{Coul}} \omega_{\widetilde{\text{Max}}} \zeta_2^{\text{Coul}} \\ &= \int \left(-\dot{\zeta}_1^{\text{Coul}}(t, \vec{x}) \vec{\zeta}_2^{\text{Coul}}(t, \vec{x}) + \vec{\zeta}_1^{\text{Coul}}(t, \vec{x}) \dot{\zeta}_2^{\text{Coul}}(t, \vec{x}) \right) d\vec{x}. \end{aligned} \quad (4.7)$$

Note that the integrand of (4.7) behaves as $O(|\vec{x}|^{-4})$, hence is integrable.

Proposition 4.1 *Let $\zeta \in \mathcal{Y}_{\widetilde{\text{Max}}}$. We have the following equivalence:*

- (1) $\zeta \in \operatorname{Ker} \omega_{\widetilde{\text{Max}}}$.
- (2) $\zeta^{\text{Coul}} = 0$.
- (3) $\zeta = \partial \chi$.

Proof. (2) \Rightarrow (3) follows from (4.6).

The implication (3) \Rightarrow (1) follows from the gauge invariance of the form $\omega_{\widetilde{\text{Max}}}$.

Let us prove (1) \Rightarrow (2). Let $\zeta^{\text{Coul}} \neq 0$. Then one of the transversal functions $\mathbb{R}^3 \ni \vec{x} \mapsto \vec{\zeta}(0, \vec{x}), \dot{\zeta}(0, \vec{x})$ is nonzero. Therefore we can find transversal functions \vec{u}, \vec{v} in $C_c^\infty(\mathbb{R}^3, \mathbb{R}^3)$ such that

$$\int \left(-\vec{u}(\vec{x}) \vec{\zeta}^{\text{Coul}}(0, \vec{x}) + v(\vec{x}) \dot{\zeta}^{\text{Coul}}(0, \vec{x}) \right) d\vec{x} \neq 0. \quad (4.8)$$

There exists a unique $\xi \in C_{\text{sc}}^\infty(\mathbb{R}^4, \mathbb{R}^4)$ such that

$$\dot{\xi}(0, \vec{x}) = (0, \vec{u}(\vec{x})), \quad \xi(0, \vec{x}) = (0, \vec{v}(\vec{x})), \quad \square \xi = 0.$$

ξ clearly belongs to $\mathcal{Y}_{\widetilde{\text{Max}}}$ and is in the Coulomb gauge. We have

$$\begin{aligned} \xi \omega_{\widetilde{\text{Max}}} \xi &= \xi \omega_{\widetilde{\text{Max}}} \xi^{\text{Coul}} \\ &= \int \left(-\dot{\xi}(0, \vec{x}) \vec{\zeta}^{\text{Coul}}(0, \vec{x}) + \vec{\xi}(0, \vec{x}) \dot{\zeta}^{\text{Coul}}(0, \vec{x}) \right) d\vec{x}, \end{aligned}$$

which equals (4.8) and is nonzero. Hence $\xi \notin \operatorname{Ker} \omega_{\widetilde{\text{Max}}}$. \square

Define

$$\mathcal{Y}_{\text{Max}} := \mathcal{Y}_{\text{Max}}^{\sim} / \text{Ker} \omega_{\text{Max}}^{\sim}.$$

In other words, \mathcal{Y}_{Max} is obtained by the *symplectic reduction* of the presymplectic space $\mathcal{Y}_{\text{Max}}^{\sim}$. Clearly, \mathcal{Y}_{Max} is equipped with a natural *symplectic form* ω_{Max} . $\mathbb{R}^{1,3} \times O^{\uparrow}(1,3)$ acts on \mathcal{Y}_{Max} by symplectic transformations.

By Prop. 4.1, \mathcal{Y}_{Max} consists of gauge equivalence classes of $\mathcal{Y}_{\text{Max}}^{\sim}$.

Analogously we define the space $\mathbb{C}\mathcal{Y}_{\text{Max}}$ of gauge classes of complex smooth space-compact solutions of (4.4).

4.1.2 Classical 4-potentials

$A_{\mu}(x)$ denotes the functional on $\mathcal{Y}_{\text{Max}}^{\sim}$ given by

$$\langle A_{\mu}(x) | \zeta \rangle := \zeta^{\mu}(x). \quad (4.9)$$

Obviously, $A_{\mu}(x)$ is not defined on \mathcal{Y}_{Max} .

We introduce also the functional $A_{\mu}^{\text{Coul}}(x)$ on $\mathcal{Y}_{\text{Max}}^{\sim}$, called the *classical 4-potential in the Coulomb gauge*,

$$A_0^{\text{Coul}}(x) := 0, \quad \vec{A}^{\text{Coul}}(x) := \vec{A}_{\text{tr}}(x) = \vec{A}(x) - \vec{\partial} \Delta^{-1} \text{div} \vec{A}(x).$$

Note that

$$\langle A_{\mu}^{\text{Coul}}(x) | \zeta \rangle = \langle A_{\mu}(x) | \zeta^{\text{Coul}} \rangle = \zeta_{\mu}^{\text{Coul}}(x),$$

where ζ^{Coul} on the right hand side is the representative of the class ζ in the Coulomb gauge. $A^{\text{Coul}}(x)$ does not depend on the gauge, hence can be interpreted as a functional on \mathcal{Y}_{Max} . It is not, however, Lorentz covariant.

Moreover, we introduce the functionals $F_{\mu\nu}(x)$ on $\mathcal{Y}_{\text{Max}}^{\sim}$, called the *fields*:

$$\langle F_{\mu\nu}(x) | \zeta \rangle := \partial_{\mu} \zeta_{\nu}(x) - \partial_{\nu} \zeta_{\mu}(x).$$

They also do not depend on the gauge, hence can be interpreted as functionals on \mathcal{Y}_{Max} . They are moreover Lorentz covariant.

We will write $E_i(x) = F_{0i}(x)$. Clearly, $\vec{E} = \partial_t \vec{A}^{\text{Coul}}$ and

$$\text{div} \vec{A}^{\text{Coul}}(x) = 0, \quad \text{div} \vec{E}(x) = 0. \quad (4.10)$$

In what follows we will usually drop the subscript Coul from $A^{\text{Coul}}(x)$. This introduces a possible ambiguity with $A(x)$ defined in (4.9). However, when we speak about \mathcal{Y}_{Max} , then (4.9) is ill defined, only $A^{\text{Coul}}(x)$ is well defined, so we think that the risk of confusion is small.

The symplectic structure on the space \mathcal{Y}_{Max}

$$\omega_{\text{Max}} = \int A^i(t, \vec{x}) \wedge E_i(t, \vec{x}) d\vec{x}$$

together with the constraint (4.10) leads to a *Poisson bracket* on the level of functions on \mathcal{Y}_{Max} :

$$\begin{aligned}\{A_i(t, \vec{x}), A_j(t, \vec{y})\} &= \{E_i(t, \vec{x}), E_j(t, \vec{y})\} = 0, \\ \{A_i(t, \vec{x}), E_j(t, \vec{y})\} &= \left(\delta_{ij} - \frac{\partial_i \partial_j}{\Delta} \right) \delta(\vec{x} - \vec{y}).\end{aligned}$$

From the above relations we deduce

$$\{A_i(x), A_j(y)\} = \left(\delta_{ij} - \frac{\partial_i \partial_j}{\Delta} \right) D(x - y).$$

4.1.3 Smearred 4-potentials

We can use the symplectic form to pair distributions and solutions. For $\zeta \in \mathcal{Y}_{\text{Max}}$ we introduce the corresponding *spatially smeared 4-potentials*, which is the functional on \mathcal{Y}_{Max} given by

$$\langle A((\zeta)) | \rho \rangle := \rho \omega_{\text{Max}} \bar{\zeta}, \quad \rho \in \mathbb{C} \mathcal{Y}_{\text{Max}}.$$

Note that

$$\begin{aligned}\{A((\zeta_1)), A((\zeta_2))\} &= \bar{\zeta}_1 \omega_{\text{Max}} \bar{\zeta}_2. \\ A((\zeta)) &= \int \left(-\overline{\zeta_\mu(t, \vec{x})} A^\mu(t, \vec{x}) + \overline{\zeta_\mu(t, \vec{x})} E^\mu(t, \vec{x}) \right) d\vec{x}.\end{aligned}\quad (4.11)$$

Let us stress that $A((\zeta))$ depends on ζ only modulo gauge transformations and is Lorentz covariant.

We can also introduce *space-time smeared 4-potentials in the Coulomb gauge*, which are the functionals on \mathcal{Y}_{Max} , for $f \in C_c^\infty(\mathbb{R}^{1,3}, \mathbb{R}^{1,3})$ given by

$$A[f] := \int f^\mu(x) A_\mu(x) dx. \quad (4.12)$$

Note that $A[f] = A((\zeta))$, where

$$\zeta_i = -D * \left(f_i - \frac{\partial_i \partial^j}{\Delta} f_j \right), \quad \zeta_0 = 0.$$

(4.12) is not Lorentz covariant. To see this it is enough to note that it does not depend on f^0 . Replacing $[f^\mu]$ with $[f^\mu + \partial^\mu \chi]$ for $\chi \in C_c^\infty(\mathbb{R}^{1,3})$ does not change (4.12), because $\partial_\mu A^\mu(x) = 0$.

4.1.4 Lagrangian formalism and the stress-energy tensor

The Euler-Lagrange equations for the Lagrangian density

$$\mathcal{L} := -\frac{1}{4} F_{\mu\nu} F^{\mu\nu}$$

coincide with the Maxwell equation.

The *canonical stress-energy tensor* is

$$\begin{aligned}\mathcal{T}_{\text{can}}^{\mu\nu} &= g^{\mu\nu} \mathcal{L} - \frac{\partial \mathcal{L}}{\partial A_{\alpha,\mu}} A_{\alpha}{}^{\nu} \\ &= -g^{\mu\nu} \frac{1}{4} F_{\alpha\beta} F^{\alpha\beta} - F^{\mu\alpha} A_{\alpha}{}^{\nu}.\end{aligned}$$

One usually replaces it with the *Belifante-Rosenfeld stress-energy tensor*. It is defined as

$$\begin{aligned}\mathcal{T}^{\mu\nu} &= \mathcal{T}_{\text{can}}^{\mu\nu} + \partial_{\alpha} \Sigma^{\mu\nu\alpha} \\ &= -g^{\mu\nu} \frac{1}{4} F_{\alpha\beta} F^{\alpha\beta} + F^{\mu\alpha} F_{\alpha}{}^{\nu},\end{aligned}$$

where

$$\Sigma_{\mu\nu\alpha} = -\Sigma_{\alpha\nu\mu} := F_{\mu\alpha} A_{\nu}. \quad (4.13)$$

On solutions of the Euler-Lagrange equations we have

$$\partial^{\mu} \mathcal{T}_{\mu\nu}^{\text{can}} = \partial^{\mu} \mathcal{T}_{\mu\nu} = 0.$$

In addition, $\mathcal{T}_{\mu\nu}$ is symmetric.

To pass to the Hamiltonian formalism we use the Coulomb gauge, writing A_{μ} for A_{μ}^{Coul} . Recall that in this gauge $A_0 = 0$ and $\text{div} \vec{A} = 0$. The variable conjugate to A_i is $\partial_{\vec{A}_i} \mathcal{L} = E^i$, which also satisfies $\text{div} \vec{E} = 0$. We express $\mathcal{T}_{\mu\nu}^{\text{can}}$ and $\mathcal{T}_{\mu\nu}$ in terms of \vec{A} and \vec{E} . We introduce the Hamiltonian, momentum and *polarization density*

$$\begin{aligned}\mathcal{H}(x) := \mathcal{T}^{00}(x) &= \frac{1}{2} \left(\vec{E}^2(x) + (\text{rot} \vec{A})^2(x) \right), \\ \mathcal{P}^j(x) := \mathcal{T}^{0j}(x) &= E^i(x) F^{ji}(x), \\ \mathcal{S}(x) &= E_i(x) \epsilon^{ijk} \partial_k A_j(x).\end{aligned}$$

They yield the Hamiltonian, momentum and *polarization* as in (3.20) satisfying analogous properties.

4.1.5 Diagonalization of the equations of motion

As in the massive case, we would like to diagonalize simultaneously the Hamiltonian, momentum, polarization and symplectic form.

For $\vec{k} \in \mathbb{R}^3$ we set $k = (\varepsilon, \vec{k})$, $\varepsilon(\vec{k}) := \sqrt{\vec{k}^2}$. The vectors $u(k, \pm 1)$ are defined as in (3.23). $u(k, 0)$ are not defined at all.

For $\sigma = \pm 1$, define the following functionals on \mathcal{Y}_{Max} , called *plane wave functionals*:

$$\begin{aligned}&a(k, \sigma) \\ &= \int \left(\sqrt{\frac{\varepsilon(\vec{k})}{2}} e^{-i\vec{x}\vec{k}} u_j(k, \sigma) A^j(0, \vec{x}) - \frac{i}{\sqrt{2\varepsilon(\vec{k})}} e^{-i\vec{k}\vec{x}} u_j(k, \sigma) E^j(0, \vec{x}) \right) \frac{d\vec{x}}{\sqrt{(2\pi)^3}}.\end{aligned}$$

We have accomplished the promised diagonalization

$$\begin{aligned}
H &= \sum_{\sigma=\pm 1} \int d\vec{k} \varepsilon(\vec{k}) a^*(k, \sigma) a(k, \sigma), \\
\vec{P} &= \sum_{\sigma=\pm 1} \int d\vec{k} \vec{k} a^*(k, \sigma) a(k, \sigma), \\
S &= \sum_{\sigma=\pm 1} \int d\vec{k} \sigma |\vec{k}| a^*(k, \sigma) a(k, \sigma), \\
i\omega_{\text{Max}} &= \sum_{\sigma=\pm 1} \int a^*(k, \sigma) \wedge a(k, \sigma) d\vec{k}.
\end{aligned}$$

The 4-potentials can be written as

$$A_\mu(x) = \sum_{\sigma=\pm 1} \int \frac{d\vec{k}}{\sqrt{(2\pi)^3} \sqrt{2\varepsilon(\vec{k})}} \left(u_\mu(x, \sigma) e^{ikx} a(k, \sigma) + \overline{u_\mu(x, \sigma)} e^{-ikx} a^*(k, \sigma) \right).$$

Plane waves are defined as in the massive case, with $\sigma = \pm 1$. We have

$$a(k, \sigma) = iA(|k, \sigma))$$

and

$$A_\mu(x) = \sum_{\sigma=\pm 1} \int \left((x|k, \sigma) a(k, \sigma) + \overline{(x|k, \sigma)} a^*(k, \sigma) \right) d\vec{k}.$$

4.1.6 Positive frequency space

$\mathcal{W}_{\text{Max}}^{(\pm)}$ will denote the subspace of $\mathbb{C}\mathcal{Y}_{\text{Max}}$ consisting of classes of solutions that in the Coulomb gauge have positive, resp. negative frequencies.

Every $g \in \mathcal{W}_{\text{Max}}^{(+)}$ can be written as

$$g(x) = \sum_{\sigma=\pm 1} \int \frac{d\vec{k}}{\sqrt{(2\pi)^3} \sqrt{2\varepsilon(\vec{k})}} e^{ikx} u(k, \sigma) \langle a(k, \sigma) | g \rangle.$$

For $g_1, g_2 \in \mathcal{W}_{\text{Max}}^{(+)}$ we define the scalar product

$$(g_1 | g_2) := i\bar{g}_1 \omega_{\text{Max}} g_2 = \sum_{\sigma=\pm 1} \int \overline{\langle a(k, \sigma) | g_1 \rangle} \langle a(k, \sigma) | g_2 \rangle d\vec{k}. \quad (4.14)$$

The definition of $\mathcal{W}_{\text{Max}}^{(+)}$ depends on the choice of coordinates. It is however easy to see that the space $\mathcal{W}_{\text{Max}}^{(+)}$ is invariant w.r.t. $\mathbb{R}^{1,3} \times O^\uparrow(1, 3)$.

We set \mathcal{Z}_{Max} to be the completion of $\mathcal{W}_{\text{Max}}^{(+)}$ in this scalar product.

We have

$$\langle a(k, \sigma) | g \rangle = (k, \sigma | g).$$

We can identify \mathcal{Z}_{Max} with $L^2(\mathbb{R}^3, \mathbb{C}^2)$ and rewrite (4.14) as

$$(g_1|g_2) = \sum_{\sigma=\pm 1} \int \overline{(k, \sigma|g_1)}(k, \sigma|g_2) d\vec{k}.$$

We can identify \mathcal{Y}_{Max} with $\mathcal{W}_{\text{Max}}^{(+)}$ and transport the scalar product onto \mathcal{Y}_{Max} , which for ζ_1, ζ_2 is given by

$$\begin{aligned} \langle \zeta_1 | \zeta_2 \rangle_{\mathcal{Y}} &:= \text{Re}(\zeta_1^{(+)} | \zeta_2^{(+)}) \\ &= \int \int (\zeta_{1i}^{\text{Coul}}(0, \vec{x})(-i)D^{(+)}(0, \vec{x} - \vec{y})\zeta_{2i}^{\text{Coul}}(0, \vec{y}) d\vec{x}d\vec{y} \\ &\quad + \int \int \zeta_{1i}^{\text{Coul}}(0, \vec{x})(-\Delta_{\vec{x}})(-i)D^{(+)}(0, \vec{x} - \vec{y})\zeta_{2i}^{\text{Coul}}(0, \vec{y}) d\vec{x}d\vec{y}. \end{aligned}$$

4.1.7 Spin averaging

Let us describe the *spin averaging identities* useful in computations of scattering cross-sections. For a given $k \in \mathbb{R}^{1,3}$ with $k^2 = 0$, let M, N be vectors with

$$M^\mu k_\mu = N^\nu k_\nu = 0.$$

Then we have

$$\sum_{\sigma=\pm 1} \overline{M^\mu u_\mu(k, \sigma)} u_\nu(k, \sigma) N^\nu = \overline{M^\mu} N_\mu. \quad (4.15)$$

To see (4.15), note that

$$\sum_{\sigma=\pm 1} \overline{u_\mu(k, \sigma)} u_\nu(k, \sigma) = g_{\mu\nu} + \delta_{\mu 0} \delta_{\nu 0} - \frac{\vec{k}_\mu \vec{k}_\nu}{|\vec{k}|^2}.$$

Therefore, the left hand side of (4.15) equals

$$\overline{M^\mu} g_{\mu\nu} N^\nu + \overline{M^0} N^0 - \frac{(\overline{M\vec{k}})(\vec{N}\vec{k})}{|\vec{k}|^2}.$$

But

$$M^0 = \frac{\vec{k}\vec{M}}{|\vec{k}|}, \quad N^0 = \frac{\vec{k}\vec{N}}{|\vec{k}|}.$$

4.1.8 Quantization

We would like to quantize the Maxwell equation starting from the symplectic space \mathcal{Y}_{Max} . We will use the 4-potentials in the Coulomb gauge (where, as usual, we drop the superscript Coul). The quantization is similar to the Proca equation based on \mathcal{Y}_{Pr} described in Subsubsection. 3.2.3, with Condition (1) replaced by

$$-\square \hat{A}_i(x) = 0, \quad \partial_i \hat{A}_i(x) = 0, \quad \hat{A}_0(x) = 0,$$

and Condition (2) replaced by

$$\begin{aligned} [\hat{A}_i(0, \vec{x}), A_j(0, \vec{y})] &= [\hat{E}_i(0, \vec{x}), \hat{E}_j(0, \vec{y})] = 0, \\ [\hat{A}_i(0, \vec{x}), \hat{E}_j(0, \vec{y})] &= i \left(\delta_{ij} - \frac{\partial_i \partial_j}{\Delta} \right) \delta(\vec{x} - \vec{y}). \end{aligned}$$

The above problem has a solution unique up to a unitary equivalence. We set $\mathcal{H} := \Gamma_s(\mathcal{Z}_{\text{Max}})$. The creation operators will be denoted by

$$\hat{a}^*(k, \sigma) = \hat{a}^*(|k, \sigma\rangle).$$

Ω will be the Fock vacuum. We set

$$\hat{A}_i(x) := \int \frac{d\vec{k}}{\sqrt{(2\pi)^3} \sqrt{2\varepsilon(\vec{k})}} \sum_{\sigma=\pm 1} \left(u_i(k, \sigma) e^{ikx} \hat{a}(k, \sigma) + \overline{u_i(k, \sigma)} e^{-ikx} \hat{a}^*(k, \sigma) \right),$$

The quantum Hamiltonian, momentum and polarization are

$$\begin{aligned} \hat{H} &:= \sum_{\sigma=\pm 1} \int \hat{a}^*(k, \sigma) \hat{a}(k, \sigma) \varepsilon(\vec{k}) d\vec{k}, \\ \vec{\hat{P}} &:= \sum_{\sigma=\pm 1} \int \hat{a}^*(k, \sigma) \hat{a}(k, \sigma) \vec{k} d\vec{k}, \\ \hat{S} &:= \sum_{\sigma=\pm 1} \int d\vec{k} \sigma |\vec{k}| \hat{a}^*(k, \sigma) \hat{a}(k, \sigma). \end{aligned}$$

The whole group $\mathbb{R}^{1,3} \rtimes O^\uparrow(1, 3)$ is unitarily implemented on \mathcal{H} by $U(y, \Lambda) := \Gamma\left(r_{(y, \Lambda)} \Big|_{\mathcal{Z}_{\text{Max}}}\right)$. We have

$$U(y, \Lambda) \hat{F}_{\mu\nu}(x) U(y, \Lambda)^* = \Lambda_\mu^{\mu'} \Lambda_\nu^{\nu'} \hat{F}_{\mu'\nu'}((y, \Lambda)x).$$

Moreover,

$$[\hat{A}_j(x), \hat{A}_i(y)] = -i \left(\delta_{ij} - \frac{\partial_i \partial_j}{\Delta} \right) D(x - y).$$

Note the identities

$$\begin{aligned} (\Omega | \hat{A}_i(x) \hat{A}_j(y) \Omega) &= -i \left(\delta_{ij} - \frac{\partial_i \partial_j}{\Delta} \right) D^{(+)}(x - y), \\ (\Omega | T(\hat{A}_i(x) \hat{A}_j(y)) \Omega) &= -i \left(\delta_{ij} - \frac{\partial_i \partial_j}{\Delta} \right) D^c(x - y). \end{aligned}$$

The family

$$C_c^\infty(\mathbb{R}^{1,3}, \mathbb{R}^{1,3}) \ni f \mapsto \hat{A}[f] := \int f^\mu(x) \hat{A}_\mu(x) dx$$

with $\mathcal{D} := \Gamma_s^{\text{fin}}(\mathcal{Z}_{\text{Max}})$ does not satisfy the Wightman axioms because of two problems: the noncausality of the commutator and the absence of the Poincaré covariance.

If we replace \hat{A}_μ with $\hat{F}_{\mu\nu}$, we restore the causality and the Poincaré covariance.

For an open set $\mathcal{O} \subset \mathbb{R}^{1,3}$ we set

$$\mathfrak{A}(\mathcal{O}) := \{\exp(i\hat{F}[f]) : f \in C_c^\infty(\mathcal{O}, \otimes_a^2 \mathbb{R}^{1,3})\}.$$

The algebras $\mathfrak{A}(\mathcal{O})$ satisfy the Haag-Kastler axioms.

4.1.9 Quantization in terms of C^* -algebras

Let $\text{CCR}(\mathcal{Y}_{\text{Max}})$ denote the (Weyl) C^* -algebra of canonical commutation relations over \mathcal{Y}_{Max} . By definition, it is generated by $W(\zeta)$, $\zeta \in \mathcal{Y}_{\text{Max}}$, such that

$$W(\zeta_1)W(\zeta_2) = e^{-i\frac{\zeta_1 \omega_{\text{Max}} \zeta_2}{2}} W(\zeta_1 + \zeta_2), \quad W(\zeta)^* = W(-\zeta).$$

$\mathbb{R}^{1,3} \rtimes \mathcal{O}^\uparrow(1,3)$ acts on $\text{CCR}(\mathcal{Y}_{\text{Max}})$ by $*$ -automorphisms defined by

$$\hat{r}_{(y,\Lambda)}(W(\zeta)) := W(r_{(y,\Lambda)}(\zeta)).$$

We are looking for a cyclic representation of this algebra with the time evolution generated by a positive Hamiltonian.

Consider the state on $\text{CCR}(\mathcal{Y}_{\text{Max}})$ defined for $\zeta \in \mathcal{Y}_{\text{Max}}$ by

$$\psi(W(\zeta)) = \exp\left(-\frac{1}{2}\langle \zeta | \zeta \rangle_{\mathcal{Y}}\right).$$

Note that the state is gauge and Poincaré invariant. Let $(\mathcal{H}_\psi, \pi_\psi, \Omega_\psi)$ be the GNS representation. \mathcal{H}_ψ is naturally isomorphic to $\Gamma_s(\mathcal{Z}_{\text{Max}})$. Ω_ψ can be identified with the vector Ω . $\pi_\psi(W(\zeta))$ can be identified with $e^{i\hat{A}(\zeta)}$. In particular, if ζ_1 and ζ_2 are gauge equivalent, then $\hat{A}(\zeta_1) = \hat{A}(\zeta_2)$. However, $\hat{A}(x)$ in the sense of (4.9) is not well defined.

4.2 Massless photons with an external 4-current

4.2.1 Classical fields

We return to the classical Maxwell equation. We consider an external 4-current given by function $\mathbb{R}^{1,3} \ni x \mapsto J(x) = [J^\mu(x)] \in \mathbb{R}^{1,3}$ satisfying

$$\partial_\nu J^\nu(x) = 0. \tag{4.16}$$

In most of this subsection we assume that J is Schwartz. The Maxwell equation reads

$$-\partial_\mu \partial^\mu A_\nu + \partial_\nu \partial_\mu A^\mu = -J_\nu. \tag{4.17}$$

Let ζ be a solution of

$$-\partial_\mu \partial^\mu \zeta_\nu + \partial_\nu \partial_\mu \zeta^\mu = -J_\nu. \quad (4.18)$$

We write separately the temporal and spatial equations:

$$\begin{aligned} -\Delta \zeta_0 + \operatorname{div} \dot{\vec{\zeta}} &= -J_0, \\ (\partial_0^2 - \Delta) \vec{\zeta} - \vec{\partial} \dot{\zeta}_0 + \vec{\partial} \operatorname{div} \vec{\zeta} &= -\vec{J}. \end{aligned}$$

We can compute ζ_0 in terms of $\vec{\zeta}$ at the same time:

$$\zeta_0(x) = \Delta^{-1}(J_0 + \partial_0 \operatorname{div} \vec{\zeta})(x). \quad (4.19)$$

We can insert this into spatial equations, using $\dot{J}_0 = \operatorname{div} \vec{J}$, obtaining

$$\square \vec{\zeta}_{\text{tr}} = \vec{J}_{\text{tr}}, \quad (4.20)$$

where

$$\begin{aligned} \vec{\zeta}_{\text{tr}} &:= \vec{\zeta} - \vec{\partial} \Delta^{-1} \operatorname{div} \vec{\zeta}, \\ \vec{J}_{\text{tr}} &:= \vec{J} - \vec{\partial} \Delta^{-1} \operatorname{div} \vec{J}. \end{aligned}$$

Thus $\vec{\zeta}_{\text{tr}}$ can be treated as the only dynamical variables. $\operatorname{div} \vec{\zeta} =: \Theta$ is an arbitrary space-time function, which can be used to determine ζ_0 .

The simplest choice is $\Theta = 0$, which corresponds to the *Coulomb gauge*:

$$\begin{aligned} \zeta_0 &= \Delta^{-1} J_0, \\ \square \vec{\zeta} &= \vec{J}_{\text{tr}}, \\ \operatorname{div} \vec{\zeta} &= 0. \end{aligned} \quad (4.21)$$

The Coulomb gauge seems to be the most natural gauge for the Hamiltonian approach.

Let ζ be a space compact solution of (4.18). Setting

$$\zeta_\mu^{\text{Coul}} := \zeta_\mu + \partial_\mu \chi,$$

where $\chi(t, \vec{x}) := (-\Delta)^{-1} \operatorname{div} \vec{\zeta}(t, \vec{x})$, we obtain a solution of (4.21). ζ^{Coul} is the unique solution of (4.21) gauge equivalent to ζ . It does not have to be space compact.

Thus the *classical 4-potential in the Coulomb gauge* $A^{\text{Coul}}(x)$ satisfies

$$\begin{aligned} A_0^{\text{Coul}} &= -(-\Delta)^{-1} J_0, \\ \square \vec{A}^{\text{Coul}} &= \vec{J}_{\text{tr}}, \\ \operatorname{div} \vec{A}^{\text{Coul}} &= 0. \end{aligned}$$

The electric field is $\vec{E} = \dot{\vec{A}} - \vec{\partial} A_0$. It is easy to see that if we use the Coulomb gauge, then $\vec{E}_{\text{tr}} = \dot{\vec{A}}^{\text{Coul}}$.

Similarly as in the previous subsection, we will drop the superscript Coul in what follows.

4.2.2 Lagrangian and Hamiltonian formalism

The Lagrangian density is

$$\begin{aligned}\mathcal{L} &:= -\frac{1}{4}F_{\mu\nu}F^{\mu\nu} - J_\mu A^\mu \\ &= -\frac{1}{2}(\text{rot}\vec{A})^2 + \frac{1}{2}(\vec{\partial}A_0)^2 + \frac{1}{2}(\dot{\vec{A}})^2 - \dot{\vec{A}}\vec{\partial}A_0 - \vec{J}\vec{A} + J_0A_0.\end{aligned}$$

We will use the Coulomb gauge. Thus we assume that $A_0 = \Delta^{-1}J_0$ and the only dynamical variable is \vec{A} satisfying $\text{div}\vec{A} = 0$. Using the transversality of \vec{A} we can rewrite the Lagrangian density as

$$\begin{aligned}\mathcal{L} &= -\frac{1}{2}(\vec{\partial}\vec{A})^2 + \frac{1}{2}(\dot{\vec{A}})^2 - \vec{J}\vec{A} \\ &\quad + \frac{1}{2}(\vec{\partial}A_0)^2 + J_0A_0.\end{aligned}$$

The conjugate variable is $\vec{E}_{\text{tr}}(x) = \dot{\vec{A}}(x)$. Thus we have the Poisson brackets

$$\begin{aligned}\{A_i(t, \vec{x}), A_j(t, \vec{y})\} &= \{E_{\text{tr}i}(t, \vec{x}), E_{\text{tr}j}(t, \vec{y})\} = 0, \\ \{A_i(t, \vec{x}), E_{\text{tr}j}(t, \vec{y})\} &= \left(\delta_{ij} - \frac{\partial_i\partial_j}{\Delta}\right)\delta(\vec{x} - \vec{y}).\end{aligned}$$

Note that \vec{E} differs from \vec{E}_{tr} by a c-number function $-\vec{\partial}A_0$. Therefore, \vec{E} satisfies the same commutation relations as \vec{E}_{tr} .

The canonical Hamiltonian density is

$$\begin{aligned}\mathcal{H}^{\text{can}}(x) &= -\mathcal{L}(x) + \vec{E}_{\text{tr}}\dot{\vec{A}}(x) \\ &= \frac{1}{2}(\vec{\partial}\vec{A})^2(x) + \frac{1}{2}(\vec{E}_{\text{tr}})^2(x) + \vec{J}(x)\vec{A}(x) \\ &\quad - \frac{1}{2}(\vec{\partial}A_0)^2(x) - J_0(x)A_0(x).\end{aligned}$$

We add to it a spatial divergence $\text{div}(A_0(x)\vec{\partial}A_0(x))$ and express A_0 in terms of J_0 . We obtain the usual Hamiltonian density

$$\begin{aligned}\mathcal{H}(x) &= \frac{1}{2}\vec{E}_{\text{tr}}^2(x) + \frac{1}{2}(\vec{\partial}\vec{A})^2(x) + \vec{J}(x)\vec{A}(x) \\ &\quad + \frac{1}{2}J_0(-\Delta)^{-1}J_0(x).\end{aligned}$$

Similarly as in the massive case, the Hamiltonian

$$H(t) = \int \mathcal{H}(t, \vec{x})d\vec{x} = \int \mathcal{H}^{\text{can}}(t, \vec{x})d\vec{x} \quad (4.22)$$

generates the equations of motion and we can interpret interacting fields as functionals on \mathcal{Y}_{Max} satisfying

$$\vec{A}(0, \vec{x}) = \vec{A}_{\text{fr}}(0, \vec{x}), \quad \vec{E}(0, \vec{x}) = \vec{E}_{\text{fr}}(0, \vec{x}).$$

4.2.3 Quantization

To quantize the Maxwell equation in the presence of an external 4-current we will use the Coulomb gauge, dropping as usual the subscript Coul.

We are looking for quantum 4-potentials $\mathbb{R}^{1,3} \ni x \mapsto \hat{A}_\mu(x)$ satisfying

$$\begin{aligned}\hat{A}_0^{\text{Coul}} &= -(-\Delta)^{-1}J_0, \\ \square \vec{\hat{A}}^{\text{Coul}} &= \vec{J}_{\text{tr}}, \\ \text{div} \vec{\hat{A}}^{\text{Coul}} &= 0,\end{aligned}$$

having the following commutation relations with $\vec{E}(x) = \dot{\vec{\hat{A}}}(x) - \vec{\partial}\hat{A}_0(x)$.

$$\begin{aligned}[\hat{A}_i(t, \vec{x}), \hat{A}_j(t, \vec{y})] &= [\hat{E}_i(t, \vec{x}), E_j(t, \vec{y})] = 0, \\ [A_i(t, \vec{x}), E_j(t, \vec{y})] &= i \left(\delta_{ij} - \frac{\partial_i \partial_j}{\Delta} \right) \delta(\vec{x} - \vec{y}).\end{aligned}$$

The above conditions determine \hat{A}_0 . To fix $\vec{\hat{A}}$ and \vec{E} we assume that they coincide with their free quantum counterparts at $t = 0$:

$$\begin{aligned}\vec{\hat{A}}(0, \vec{x}) &= \vec{\hat{A}}_{\text{fr}}(0, \vec{x}) =: \vec{\hat{A}}(\vec{x}), \\ \vec{E}(0, \vec{x}) &= \vec{E}_{\text{fr}}(0, \vec{x}) =: \vec{E}(\vec{x}).\end{aligned}$$

The Schrödinger picture Hamiltonian and the corresponding interaction picture Hamiltonian are

$$\begin{aligned}\hat{H}(t) &= \int d\vec{x} : \left(\frac{1}{2} \vec{E}^2(\vec{x}) + \frac{1}{2} (\vec{\partial} \vec{\hat{A}})^2(\vec{x}) + \vec{J}(t, \vec{x}) \vec{\hat{A}}(\vec{x}) \right) : \\ &\quad + \frac{1}{2} \int \int d\vec{x} d\vec{y} J^0(t, \vec{x}) \frac{1}{4\pi|\vec{x} - \vec{y}|} J^0(t, \vec{y}), \\ \hat{H}_{\text{Int}}(t) &= + \int d\vec{x} \vec{J}(t, \vec{x}) \vec{\hat{A}}_{\text{fr}}(t, \vec{x}) \\ &\quad + \frac{1}{2} \int \int d\vec{x} d\vec{y} J^0(t, \vec{x}) \frac{1}{4\pi|\vec{x} - \vec{y}|} J^0(t, \vec{y}).\end{aligned}$$

The *scattering operator* can be computed exactly:

$$\begin{aligned}\hat{S} &= \exp \left(\frac{i}{2} \int \frac{dk}{(2\pi)^4} \bar{J}^\mu(k) D_{\mu\nu}^{\text{Coul}}(k) J^\nu(k) \right) \\ &\quad \times \exp \left(-i \sum_{\sigma=\pm 1} \int \frac{d\vec{k}}{\sqrt{(2\pi)^3}} \hat{a}^*(k, \sigma) \frac{u_\mu(k, \sigma)}{\sqrt{2\varepsilon(\vec{k})}} J^\mu(\varepsilon(\vec{k}), \vec{k}) \right) \\ &\quad \times \exp \left(-i \sum_{\sigma=\pm 1} \int \frac{d\vec{k}}{\sqrt{(2\pi)^3}} \hat{a}(k, \sigma) \frac{u_\mu(k, \sigma)}{\sqrt{2\varepsilon(\vec{k})}} \overline{J^\mu(\varepsilon(\vec{k}), \vec{k})} \right), \quad (4.23)\end{aligned}$$

where the propagator in the *Coulomb gauge* is defined as

$$D_{00}^{\text{Coul}} = -\frac{1}{\vec{k}^2}, \quad D_{0j}^{\text{Coul}} = 0, \quad D_{ij}^{\text{Coul}} = \frac{1}{k^2 - i0} \left(\delta_{ij} - \frac{k_i k_j}{\vec{k}^2} \right).$$

We did not use the fact that J^μ is conserved.

4.2.4 Causal propagators

If we compute scattering amplitudes, we can pass from the propagator in the Coulomb gauge to another by adding $k_\mu f_\nu(k) + f_\mu(k) k_\nu$ for an arbitrary function $f_\mu(k)$. Let us list a number of useful propagators in other gauges.

We distinguish the family of propagators

$$\frac{1}{k^2 - i0} \left(g_{\mu\nu} + \left(\frac{1}{\alpha} - 1 \right) \frac{k_\mu k_\nu}{k^2} \right).$$

Some of them have special names:

$$D_{\mu\nu}^{\text{Lan}} := \frac{1}{k^2 - i0} \left(g_{\mu\nu} - \frac{k_\mu k_\nu}{k^2} \right) \quad \text{Landau or Lorentz gauge,}$$

$$D_{\mu\nu}^{\text{Feyn}} := \frac{1}{k^2 - i0} g_{\mu\nu} \quad \text{Feynman gauge,}$$

$$D_{\mu\nu}^{\text{FY}} := \frac{1}{k^2 - i0} \left(g_{\mu\nu} + 2 \frac{k_\mu k_\nu}{k^2} \right) \quad \text{Fried and Yennie gauge.}$$

We have $D_{\mu\nu}^{\text{Coul}} = D_{\mu\nu}^{\text{Feyn}} + k_\mu f_\nu^{\text{Coul}}(k) + f_\mu^{\text{Coul}}(k) k_\nu$, where

$$f_0^{\text{Coul}}(k) = \frac{k_0}{(k^2 - i0)2\vec{k}^2}, \quad f_i^{\text{Coul}}(k) = -\frac{k_i}{(k^2 - i0)2\vec{k}^2}.$$

The propagator in the *temporal gauge*

$$D_{00}^{\text{tem}} = 0, \quad D_{0j}^{\text{tem}} = 0, \quad D_{ij}^{\text{tem}} = \frac{1}{k^2 - i0} \left(\delta_{ij} - \frac{k_i k_j}{k_0^2} \right).$$

We have $D_{\mu\nu}^{\text{tem}} = D_{\mu\nu}^{\text{Feyn}} + k_\mu f_\nu^{\text{tem}}(k) + f_\mu^{\text{tem}}(k) k_\nu$, where

$$f_0^{\text{tem}}(k) = \frac{1}{(k^2 - i0)2k_0}, \quad f_i^{\text{tem}}(k) = -\frac{k_i}{(k^2 - i0)2k_0^2}.$$

4.2.5 Path integral formulation

Let $D_{\mu\nu}^\bullet$ be one of the propagators considered in Sect. 3.2.4. Let $B_{\bullet}^{\mu\nu}$ be its inverse. Then we can use the corresponding action to express the generating function by path integrals, as described in Sect. 3.2.6, where this approach for massive vector fields was considered.

The discussion of the propagators $D_{\mu\nu}^\alpha$ and $D_{\mu\nu}^{\text{tem}}$ is an obvious generalization of the massive case.

To obtain the propagator in the Coulomb gauge $D_{\mu\nu}^{\text{Coul}}$, we take the Lagrangian

$$-\frac{1}{2}\left(\partial_\mu A_i(x)\partial^\mu A_i(x) - \partial_i A_0(x)\partial_i A_0(x)\right),$$

and restrict the integration by the condition

$$\text{div}\vec{A}(x) = 0.$$

4.2.6 The $m \rightarrow 0$ limit

Assume that J^μ is a conserved 4-current. Using the propagator in the Yukawa gauge we can write the scattering operator for a positive mass as

$$\begin{aligned} \hat{S} &= \exp\left(\frac{i}{2}\int\frac{dk}{(2\pi)^4}\overline{J^i(k)}\frac{1}{m^2+k^2-i0}\left(g_{ij}-\frac{k_ik_j}{m^2+\vec{k}^2}\right)J^i(k)\right. \\ &\quad \left.-\frac{i}{2}\int\frac{dk}{(2\pi)^4}\frac{1}{\vec{k}^2+m^2}|J^0(k)|^2\right) \\ &\quad \times \exp\left(-i\sum_{\sigma=0,\pm 1}\int\frac{d\vec{k}}{\sqrt{(2\pi)^3}}\hat{a}^*(k,\sigma)\frac{\overline{u_\mu(k,\sigma)}}{\sqrt{2\varepsilon(\vec{k})}}J^\mu(k)\right) \\ &\quad \times \exp\left(-i\sum_{\sigma=0,\pm 1}\int\frac{d\vec{k}}{\sqrt{(2\pi)^3}}\hat{a}(k,\sigma)\frac{u_\mu(k,\sigma)}{\sqrt{2\varepsilon(\vec{k})}}\overline{J^\mu(k)}\right) \\ &= \hat{S}_{\text{tr}}\otimes\hat{S}_{\text{lg}}, \end{aligned}$$

(In the expressions where we use the 3-dimensional integration $d\vec{k}$, the 4-momenta are on shell, that is, $k = (\varepsilon(\vec{k}), \vec{k})$). Here, the *transversal scattering operator* is

$$\begin{aligned} \hat{S}_{\text{tr}} &= \exp\left(\frac{i}{2}\int\frac{dk}{(2\pi)^4}\overline{J^i(k)}\frac{1}{m^2+k^2-i0}\left(g_{ij}-\frac{k_ik_j}{k^2}\right)J^j(k)\right. \\ &\quad \left.-\frac{i}{2}\int\frac{dk}{(2\pi)^4}\frac{1}{\vec{k}^2+m^2}|J^0(k)|^2\right) \\ &\quad \times \exp\left(-i\sum_{\sigma=\pm 1}\int\frac{d\vec{k}}{\sqrt{(2\pi)^3}}\hat{a}^*(k,\sigma)\frac{\overline{u_\mu(k,\sigma)}}{\sqrt{2\varepsilon(\vec{k})}}J^\mu(k)\right) \\ &\quad \times \exp\left(-i\sum_{\sigma=\pm 1}\int\frac{d\vec{k}}{\sqrt{(2\pi)^3}}\hat{a}(k,\sigma)\frac{u_\mu(k,\sigma)}{\sqrt{2\varepsilon(\vec{k})}}\overline{J^\mu(k)}\right) \end{aligned}$$

and converges to the massless scattering operator in the Coulomb gauge as $m \searrow 0$. The *longitudinal scattering operator* is

$$\begin{aligned}\hat{S}_{\text{lg}} &= \exp\left(\frac{i}{2}m^2 \int \frac{d\vec{k}}{(2\pi)^4} \overline{J^i(k)} \frac{1}{m^2 + k^2 - i0} \frac{k_i k_j}{(m^2 + \vec{k}^2)\vec{k}^2} J^j(k)\right) \\ &\times \exp\left(-i \int \frac{d\vec{k}}{\sqrt{(2\pi)^3}} \hat{a}^*(k, 0) \frac{\overline{u_\mu(k, 0)}}{\sqrt{2\varepsilon(\vec{k})}} J^\mu(k)\right) \\ &\times \exp\left(-i \int \frac{d\vec{k}}{\sqrt{(2\pi)^3}} \hat{a}(k, 0) \frac{u_\mu(k, 0)}{\sqrt{2\varepsilon(\vec{k})}} J^\mu(k)\right).\end{aligned}$$

This can be rewritten as

$$\begin{aligned}\hat{S}_{\text{lg}} &= \exp\left(\frac{i}{2}m^2 \int \frac{d\vec{k}}{(2\pi)^4} \frac{|\vec{J} \cdot \vec{k}|^2}{(m^2 + k^2)(m^2 + \vec{k}^2)\vec{k}^2}\right) \\ &\times \exp\left(-\frac{1}{2} \int \frac{d\vec{k}}{(2\pi)^4} \frac{m^2 |J^0(k)|^2}{2\varepsilon(\vec{k})\vec{k}^2}\right) \\ &\times \exp\left(i \int \frac{d\vec{k}}{\sqrt{(2\pi)^3}} \hat{a}^*(k, 0) \frac{m J^0(k)}{|\vec{k}| \sqrt{2\varepsilon(\vec{k})}}\right) \\ &\times \exp\left(i \int \frac{d\vec{k}}{\sqrt{(2\pi)^3}} \hat{a}(k, 0) \frac{m \overline{J^0(k)}}{|\vec{k}| \sqrt{2\varepsilon(\vec{k})}}\right),\end{aligned}$$

where the integral on the first line should be understood as the principal value. Thus \hat{S}_{lg} , under rather general circumstances, converges to $\mathbb{1}$.

4.2.7 Current produced by a travelling particle

Consider a classical particle travelling along the trajectory $t \mapsto \vec{y}(t)$ with a constant profile $q(\vec{x})$. Then its 4-current equals

$$J(t, \vec{x}) = q(\vec{x} - \vec{y}(t)) \left(1, \frac{d\vec{y}(t)}{dt}\right).$$

Assume that $\vec{y}(t) = t\vec{v}^\pm$ for $\pm t > 0$. Then

$$\begin{aligned}J^\mu(k) &= \int J^\mu(t, \vec{x}) e^{-i\vec{k}\vec{x} + ik^0 t} dx dt \\ &= \left(-\frac{i(1, \vec{v}_+)^{\mu}}{\vec{k}\vec{v}_+ - k^0 - i0} + \frac{i(1, \vec{v}_-)^{\mu}}{\vec{k}\vec{v}_- - k^0 + i0}\right) q(\vec{k}) \\ &= \left(-\frac{ip_+^{\mu}}{kp_+ - i0} + \frac{ip_-^{\mu}}{kp_- + i0}\right) q(\vec{k}),\end{aligned}$$

where $p^\pm = \frac{m}{\sqrt{1-(\vec{v}^\pm)^2}}(1, \vec{v}^\pm)$.

Consider photons of mass $m \geq 0$ coupled to the 4-current J^μ . Similarly as in Subsubsect. 2.2.12, we define the scattering operator \hat{S}_{GL} by replacing

$$\int \frac{dk}{(2\pi)^4} \overline{J^\mu(k)} D_{\mu\nu}(k) J^\nu(k)$$

in (4.23) with

$$\text{Im} \int \frac{dk}{(2\pi)^4} \overline{J^\mu(k)} D_{\mu\nu}(k) J^\nu(k). \quad (4.24)$$

(4.24) is infrared divergent if $m = 0$, $\int q(\vec{x}) d\vec{x} \neq 0$ and $\vec{v}_+ \neq \vec{v}_-$.

We could try to justify the use of \hat{S}_{GL} similarly as in Subsubsect. 2.2.12, by introducing the Gell-Mann–Low adiabatic switching. This justification is adopted by many physicists, eg. [31]. One could criticize this approach, since after multiplying by the switching function $e^{-\epsilon|t|}$ the 4-current is no longer conserved. Therefore, as indicated above, we prefer to define the scattering operator \hat{S}_{GL} simply by removing the (typically infinite) phase shift.

4.2.8 Energy shift

Suppose that the 4-current is stationary and is given by a Schwartz function $\mathbb{R}^3 \ni \vec{x} \mapsto J^\mu(\vec{x})$ with $\text{div} \vec{J}(\vec{x}) = 0$.

The Hamiltonian is given by

$$\begin{aligned} \hat{H} &= \int d\vec{x} : \left(\frac{1}{2} \vec{E}_{\text{tr}}^2(\vec{x}) + \frac{1}{2} (\partial \vec{A}(\vec{x}))^2 + \vec{J}(\vec{x}) \vec{A}(\vec{x}) \right) : \\ &+ \frac{1}{2} \int \int d\vec{x} d\vec{y} J^0(\vec{x}) \frac{1}{4\pi|\vec{x} - \vec{y}|} J^0(\vec{y}). \end{aligned}$$

By (A.14), the infimum of \hat{H} is

$$\begin{aligned} E &= -\frac{1}{2} \int \int d\vec{x} d\vec{y} \vec{J}(\vec{x}) \frac{1}{4\pi|\vec{x} - \vec{y}|} \vec{J}(\vec{y}) \\ &+ \frac{1}{2} \int \int d\vec{x} d\vec{y} J^0(\vec{x}) \frac{1}{4\pi|\vec{x} - \vec{y}|} J^0(\vec{y}). \end{aligned}$$

4.3 Alternative approaches

4.3.1 Manifestly Lorentz covariant formalism

So far, our treatment of the Maxwell equation was based on the Coulomb gauge, which depends on the choice of the temporal coordinate. One can ask whether massless vector fields can be studied in a manifestly covariant fashion.

Let Ξ be an arbitrary space-time function. The Maxwell equation allow us to impose a *generalized Lorentz condition*

$$\partial_\mu A^\mu = \Xi. \quad (4.25)$$

The Maxwell equation together with (4.25) imply

$$-\square A^\mu = -J^\mu + \partial^\mu \Xi. \quad (4.26)$$

The function Ξ has no physical meaning. Therefore it is natural to adopt the simplest choice $\Xi = 0$, that is the usual *Lorentz condition*, for which (4.26) reads $-\square A^\mu = -J^\mu$. We will discuss this approach in what follows. For simplicity, we will limit ourselves to free fields.

4.3.2 The Lorentz condition

Recall that the Proca equation is equivalent to the Klein-Gordon equation for vector fields together with the Lorentz condition. Therefore, one can first develop its theory on the symplectic space \mathcal{Y}_{vec} , and then reduce it to the subspace \mathcal{Y}_{Lor} , as described before.

One can follow a similar route for the Maxwell equation. However, there is a difference: the reduction by the Lorentz condition is insufficient, one has to make an additional reduction.

Anyway, let us start as described in Subsect. 3.3.1 by introducing the space \mathcal{Y}_{vec} , the form ω_{vec} , the subspace \mathcal{Y}_{Lor} , the 4-potentials $A_\mu(x)$, $\Pi_\mu(x) := \dot{A}_\mu(x)$, where now $m = 0$.

In the massive case \mathcal{Y}_{Lor} was symplectic (that means, the form ω_{vec} restricted to \mathcal{Y}_{Lor} was nondegenerate). This is no longer true in the massless case. Instead, the following is true.

Proposition 4.2 *\mathcal{Y}_{Lor} is coisotropic. That means, if ζ is symplectically orthogonal to \mathcal{Y}_{Lor} , then $\zeta \in \mathcal{Y}_{\text{Lor}}$.*

Proof. Using $-\square \partial_\mu A^\mu(x) = 0$ we see that, for any fixed t , we can replace

$$\partial_\mu A^\mu(x) = 0 \quad (4.27)$$

with

$$0 = \partial_\mu A^\mu(t, \vec{x}) = (-\Pi^0 + \partial_i A^i)(t, \vec{x}), \quad (4.28)$$

$$0 = \partial_\mu \Pi^\mu(t, \vec{x}) = (-\Delta A^0 + \partial_i \dot{A}^i)(t, \vec{x}) \quad (4.29)$$

as the defining conditions for \mathcal{Y}_{Lor} . \mathcal{Y}_{Lor} is coisotropic iff

$$\{\partial_\mu A^\mu(t, \vec{x}), \partial_\nu A^\nu(t, \vec{y})\} = 0, \quad (4.30)$$

$$\{\partial_\mu \Pi^\mu(t, \vec{x}), \partial_\nu \Pi^\nu(t, \vec{y})\} = 0, \quad (4.31)$$

$$\{\partial_\mu A^\mu(t, \vec{x}), \partial_\nu \Pi^\nu(t, \vec{y})\} = 0. \quad (4.32)$$

It is clear that (4.30) and (4.31) are true. To see (4.32) we compute:

$$\begin{aligned} & \{\partial_\mu A^\mu(t, \vec{x}), \partial_\nu \Pi^\nu(t, \vec{y})\} \\ &= \Delta_{\vec{y}} \delta(\vec{x} - \vec{y}) + \partial_{\vec{x}_i} \partial_{\vec{y}_i} \delta(\vec{x} - \vec{y}) = 0. \end{aligned}$$

□

\mathcal{Y}_{Lor} is a subspace of $\mathcal{Y}_{\widehat{\text{Max}}}$ and on \mathcal{Y}_{Lor} the forms $\omega_{\widehat{\text{Max}}}$ and ω_{vec} coincide.

Proposition 4.3 Any $\zeta \in \mathcal{Y}_{\text{Max}}^{\sim}$ is gauge equivalent to an element of \mathcal{Y}_{Lor} .

Proof. We can find smooth functions ξ_+ and ξ_- such that

$$\partial_\mu \zeta^\mu = \xi_+ + \xi_-,$$

ξ_- is past space compact and ξ_+ is future space compact. By using the advanced and retarded Green's functions we can solve

$$-\square \chi_- = \xi_-, \quad -\square \chi_+ = \xi_+,$$

where χ_- is past space compact and χ_+ is future space compact. Then $\zeta_\mu + \partial_\mu \chi$ belongs to \mathcal{Y}_{Lor} . \square

Therefore, the symplectically reduced \mathcal{Y}_{Lor} coincides with the symplectically reduced $\mathcal{Y}_{\text{Max}}^{\sim}$, that is, with \mathcal{Y}_{Max} . This shows that both approaches to the Maxwell equation are equivalent on the classical level.

4.3.3 Positive frequency space

$\mathcal{W}_{\text{Lor}}^{(\pm)}$ will denote the subspace of $\mathbb{C}\mathcal{Y}_{\text{Lor}}$ consisting of solutions that have positive, resp. negative frequencies.

For $g_1, g_2 \in \mathcal{W}_{\text{Lor}}^{(+)}$ we define the scalar product

$$\begin{aligned} (g_1 | g_2) &:= i\bar{g}_1 \omega_{\text{vec}} g_2 \\ &= i\bar{g}_1^{\text{Coul}} \omega_{\text{vec}} g_2^{\text{Coul}}. \end{aligned} \quad (4.33)$$

Note that the definition (4.33) does not depend on the choice of coordinates and is invariant wrt. the group $\mathbb{R}^{1,3} \rtimes O^\dagger(1,3)$.

The scalar product is positive semidefinite, but not strictly positive definite. Let $\mathcal{W}_{\text{Lor},0}^{(+)}$ be the subspace of elements $\mathcal{W}_{\text{Lor}}^{(+)}$ with a zero norm. Using Prop. 4.1 we see that $\mathcal{W}_{\text{Lor},0}^{(+)}$ consists of pure gauges. The factor space $\mathcal{W}_{\text{Lor}}^{(+)}/\mathcal{W}_{\text{Lor},0}^{(+)}$ has a nondegenerate scalar product. Its completion is naturally isomorphic to the space \mathcal{Z}_{Max} , which we constructed in Subsubsection. 4.1.6.

We have a natural identification of \mathcal{Y}_{Lor} with $\mathcal{W}_{\text{Lor}}^{(+)}$ given by the obvious projection. For $\zeta \in \mathcal{Y}_{\text{Lor}}$ we will denote by $\zeta^{(+)}$ the corresponding element of $\mathcal{W}_{\text{Lor}}^{(+)}$. This identification allows us to define a positive semidefinite scalar product on \mathcal{Y}_{Lor} :

$$\begin{aligned} \langle \zeta_1 | \zeta_2 \rangle_{\mathcal{Y}} &:= \text{Re}(\zeta_1^{(+)} | \zeta_2^{(+)}) \\ &= \int \int \dot{\zeta}_{1i}^{\text{Coul}}(0, \vec{x}) (-i) D^{(+)}(0, \vec{x} - \vec{y}) \dot{\zeta}_{2i}^{\text{Coul}}(0, \vec{y}) d\vec{x} d\vec{y} \\ &\quad + \int \int \zeta_{1i}^{\text{Coul}}(0, \vec{x}) (-\Delta_{\vec{x}}) (-i) D^{(+)}(0, \vec{x} - \vec{y}) \zeta_{2i}^{\text{Coul}}(0, \vec{y}) d\vec{x} d\vec{y}. \end{aligned}$$

4.3.4 “First quantize, then reduce”

One can try to use the symplectic space \mathcal{Y}_{vec} of real vector valued solutions of the Klein-Gordon equation as the basis for quantization. In the literature, this starting point is employed by two approaches.

The first, which we call the *approach with a subsidiary condition* has the advantage that it uses only positive definite Hilbert spaces. Unfortunately, in this approach there are problems with the 4-potential $\hat{A}^\mu(x)$. Besides, the full Hilbert space turns out to be non-separable.

In the *Gupta-Bleuler approach* the 4-potentials $\hat{A}^\mu(x)$ are well defined and covariant. Unfortunately it uses indefinite scalar product spaces.

4.3.5 Quantization with a subsidiary condition

The quantization of the Proca equation described in Subsubsec. 3.3.6 is problematic in the zero mass limit. If $m = 0$, we cannot use the Hilbert space (3.55) for the quantization, since it is not well defined.

However, the C^* -algebraic formulation survives the $m \searrow 0$ limit. In particular, the (Weyl) C^* -algebra of canonical commutation relations over \mathcal{Y}_{vec} , introduced in (3.57) and denoted $\text{CCR}(\mathcal{Y}_{\text{vec}})$, is well defined also for $m = 0$ and is invariant wrt the Poincaré group.

Strictly speaking, the spaces \mathcal{Y}_{vec} and hence the algebras $\text{CCR}(\mathcal{Y}_{\text{vec}})$ are different for various m . If we fix a Cauchy subspace we can identify them by using the initial conditions.

Recall that in the massive case

$$(\Omega|\hat{A}((\zeta))^2\Omega) = \langle \zeta|\zeta \rangle_{\mathcal{Y}} + \frac{2}{m^2} \langle \partial_\mu \zeta^\mu | \partial_\nu \zeta^\nu \rangle_{\mathcal{Y}}. \quad (4.34)$$

Recall that $\zeta \in \mathcal{Y}_{\text{Lor}}$ iff $\partial_\mu \zeta^\mu = 0$. Therefore, in the limit $m \searrow 0$,

$$(\Omega|\hat{A}((\zeta))^2\Omega) = \begin{cases} \langle \zeta|\zeta \rangle_{\mathcal{Y}}, & \zeta \in \mathcal{Y}_{\text{Lor}}, \\ +\infty, & \zeta \notin \mathcal{Y}_{\text{Lor}}. \end{cases}$$

So, the following state on $\text{CCR}(\mathcal{Y}_{\text{vec}})$ is the limit of the state (3.58) for $m \searrow 0$:

$$\psi(W(\zeta)) = \begin{cases} \exp\left(-\frac{1}{2}\langle \zeta|\zeta \rangle_{\mathcal{Y}}\right), & \zeta \in \mathcal{Y}_{\text{Lor}}, \\ 0, & \zeta \notin \mathcal{Y}_{\text{Lor}}. \end{cases}$$

Let $(\mathcal{H}_\psi, \pi_\psi, \Omega_\psi)$ denote the *GNS representation* for this state. We can identify

$$J : \mathcal{H}_\psi \rightarrow l^2(\mathcal{Y}_{\text{vec}}/\mathcal{Y}_{\text{Lor}}, \Gamma_s(\mathcal{Z}_{\text{Max}})). \quad (4.35)$$

To describe this identification, first note that $\mathcal{Y}_{\text{vec}}/\mathcal{Y}_{\text{Lor}}$ can be parametrized by smooth space-compact functions

$$\Xi = \partial_\mu \zeta^\mu,$$

which can be called the *values of the Lorentz condition*. For each Ξ choose $\zeta_\Xi \in \mathcal{Y}_{\text{vec}}$ such that $\partial_\mu \zeta_\Xi^\mu = \Xi$. We demand that

$$\left(J\pi_\psi(W(\zeta_\Xi))\Omega_\psi \right) (\Xi) = \begin{cases} \Omega, & \partial_\mu \zeta^\mu = \Xi, \\ 0, & \partial_\mu \zeta^\mu \neq \Xi. \end{cases}$$

Then J is given by

$$\left(J\pi_\psi(W(\zeta))\Omega_\psi \right) (\Xi) = \begin{cases} e^{\frac{i}{2}\zeta\omega_{\text{vec}}\zeta_\Xi} e^{i\hat{A}((\zeta-\zeta_\Xi))}\Omega, & \partial_\mu \zeta^\mu = \Xi, \\ 0, & \partial_\mu \zeta^\mu \neq \Xi. \end{cases}$$

Note that \mathcal{H}_ψ is *non-separable* – it is an uncountable direct sum of *superselection sectors* corresponding to various values of the Lorentz condition. All these superselection sectors are separable.

Special role is played by the (separable) subspace (superselection sector) corresponding to the Lorentz condition $\Xi = 0$. We can choose $\zeta_{\Xi=0} = 0$ and thus this subspace is naturally isomorphic to $\Gamma_s(\mathcal{Z}_{\text{Max}})$ with the fields obtained by the usual quantization obtained by the method “first reduce, then quantize”.

Note that $\pi_\psi(W(\zeta))$ maps between various sectors of (4.35) if $\zeta \notin \mathcal{Y}_{\text{Lor}}$. The unitary group $\mathbb{R} \ni t \mapsto \pi_\psi(W(t\zeta))$ is strongly continuous if and only if $\zeta \in \mathcal{Y}_{\text{Lor}}$. If this is the case, we can write $\pi_\psi(W(\zeta)) = e^{i\hat{A}((\zeta))}$. We have $\hat{A}((\zeta_1)) = \hat{A}((\zeta_2))$ if in addition ζ_1 differs from ζ_2 by a pure gauge. $\hat{A}((\zeta))$ is ill defined if $\zeta \notin \mathcal{Y}_{\text{Lor}}$.

To my knowledge, the approach that we described above, restricted to the 0th sector, was essentially one of the first approaches to the quantization of Maxwell equation. It is typical for older presentations, eg. [27]. However, without the language of C^* -algebras it is somewhat awkward to describe. One usually says that the Lorentz condition $\partial_\mu \hat{A}^\mu(x) = 0$ is enforced on the Hilbert space of states and constitutes a *subsidiary condition*.

4.3.6 The Gupta-Bleuler approach

The Gupta-Bleuler approach follows the same lines as in the massive case until we arrive at the algebraic Fock space built on $\mathcal{W}_{\text{Lor}}^{(+)}$. As we know, the scalar product on $\mathcal{W}_{\text{Lor}}^{(+)}$ is only semidefinite. We factor $\mathcal{W}_{\text{Lor}}^{(+)}$ by the null space of its scalar product, obtaining $\mathcal{W}_{\text{Max}}^{(+)}$. We complete it, obtaining \mathcal{Z}_{Max} and we take the corresponding Fock space $\Gamma_s(\mathcal{Z}_{\text{Max}})$ – this coincides with the usual quantization.

Equivalently, we can take the (algebraic) Fock space over $\mathcal{W}_{\text{Lor}}^{(+)}$. It has a natural semidefinite product. We divide by its null space and take the completion. Again, the resulting Hilbert space can be naturally identified with $\Gamma_s(\mathcal{Z}_{\text{Max}})$.

5 Charged scalar bosons

In this section we consider again the *Klein-Gordon equation*

$$(-\square + m^2)\psi(x) = 0. \quad (5.1)$$

This time we will quantize the space of its *complex solutions*.

The formalism used in physics to describe complex fields, and especially to quantize them, is different from the real case, therefore we devote to it a separate section.

The advantage of complex fields, as compared with real fields, is the possibility to include an *external electromagnetic 4-potential* $A(x) = [A^\mu(x)]$ and to consider the equation

$$(-(\partial_\mu + iA_\mu(x))(\partial^\mu + iA^\mu(x)) + m^2)\psi(x) = 0.$$

5.1 Free charged scalar bosons

5.1.1 Classical fields

\mathcal{W}_{KG} will denote the space of *smooth space-compact complex solutions of the Klein-Gordon equation*

$$(-\square + m^2)\zeta = 0. \quad (5.2)$$

(In the context of neutral fields, it was denoted $\mathbb{C}\mathcal{Y}_{\text{KG}}$, because it was an auxiliary object, the *complexification of the phase space* \mathcal{Y}_{KG} . Now it is the basic object, the *phase space* itself).

Clearly, the space \mathcal{W}_{KG} is equipped with a *complex conjugation* $\zeta \mapsto \bar{\zeta}$ and a $U(1)$ *symmetry* $\zeta \mapsto e^{i\theta}\zeta$, $\theta \in \mathbb{R}/2\pi\mathbb{Z} = U(1)$.

If T is a real linear functional on \mathcal{W} , then we have two kinds of natural complex conjugations of T :

$$\langle \bar{T} | \zeta \rangle := \overline{\langle T | \bar{\zeta} \rangle}, \quad \langle T^* | \zeta \rangle := \overline{\langle T | \bar{\zeta} \rangle}. \quad (5.3)$$

Both maps $T \mapsto \bar{T}$ and $T \mapsto T^*$ are antilinear. When restricted to the real subspace $\mathcal{Y}_{\text{KG}} \subset \mathcal{W}_{\text{KG}}$, the functionals \bar{T} and T^* coincide.

A special role is played by *complex linear* functionals on \mathcal{W} . The space of such functionals will be denoted $\mathcal{W}^\#$. If $T \in \mathcal{W}^\#$, then $\bar{T} \in \mathcal{W}^\#$, unlike T^* , which is antilinear.

In the neutral case a crucial role was played by the conserved 4-current $j_\mu(\zeta_1, \zeta_2)$, where $\zeta_1, \zeta_2 \in \mathcal{Y}_{\text{KG}}$; see (2.10). In the charged case we will use its sesquilinear version defined on \mathcal{W}_{KG} :

$$j^\mu(\bar{\zeta}_1, \zeta_2, x) := \overline{\partial^\mu \zeta_1(x)} \zeta_2(x) - \bar{\zeta}_1(x) \partial^\mu \zeta_2(x). \quad (5.4)$$

If we decompose elements of \mathcal{W}_{KG} into their real and imaginary part $\zeta = \zeta_{\text{R}} + i\zeta_{\text{I}}$, then the real part of the 4-current splits into a part depending on ζ_{R} and on ζ_{I} :

$$\begin{aligned} & \text{Re} j^\mu(\bar{\zeta}_1, \zeta_2, x) \\ &= \partial^\mu \zeta_{\text{R},1}(x) \zeta_{\text{R},2}(x) - \zeta_{\text{R},1}(x) \partial^\mu \zeta_{\text{R},2}(x) \\ & \quad + \partial^\mu \zeta_{\text{I},1}(x) \zeta_{\text{I},2}(x) - \zeta_{\text{I},1}(x) \partial^\mu \zeta_{\text{I},2}(x). \end{aligned}$$

Thus \mathcal{W}_{KG} can be viewed as the direct sum of two symplectic spaces with the form

$$\text{Re} \bar{\zeta}_1 \omega \zeta_2 = \zeta_{\text{R},1} \omega \zeta_{\text{R},2} + \zeta_{\text{I},1} \omega \zeta_{\text{I},2}.$$

For $x \in \mathbb{R}^{1,3}$, one can introduce the fields $\phi_{\mathbb{R}}(x)$, $\phi_{\mathbb{I}}(x)$, $\pi_{\mathbb{R}}(x)$, $\pi_{\mathbb{I}}(x)$ as the real linear functionals on \mathcal{W}_{KG} given by

$$\langle \phi_{\mathbb{R}}(x) | \zeta \rangle := \text{Re} \zeta(x), \quad \langle \phi_{\mathbb{I}}(x) | \zeta \rangle := \text{Im} \zeta(x), \quad (5.5)$$

$$\langle \pi_{\mathbb{R}}(x) | \zeta \rangle := \text{Re} \dot{\zeta}(x), \quad \langle \pi_{\mathbb{I}}(x) | \zeta \rangle := \text{Im} \dot{\zeta}(x). \quad (5.6)$$

Clearly, we have the usual equal time Poisson brackets (we write only the non-vanishing ones):

$$\{\phi_{\mathbb{R}}(t, \vec{x}), \pi_{\mathbb{R}}(t, \vec{y})\} = \{\phi_{\mathbb{I}}(t, \vec{x}), \pi_{\mathbb{I}}(t, \vec{y})\} = \delta(\vec{x} - \vec{y}). \quad (5.7)$$

In practice instead of (5.5) and (5.6) one prefers to use *complex fields* $\psi(x)$, $\eta(x) \in \mathcal{W}^{\#}$ defined by

$$\begin{aligned} \langle \psi(x) | \zeta \rangle &:= \frac{1}{\sqrt{2}} \zeta(x), & \langle \psi^*(x) | \zeta \rangle &:= \frac{1}{\sqrt{2}} \overline{\zeta(x)}, \\ \langle \eta(x) | \zeta \rangle &:= \frac{1}{\sqrt{2}} \dot{\zeta}(x), & \langle \eta^*(x) | \zeta \rangle &:= \frac{1}{\sqrt{2}} \overline{\dot{\zeta}(x)}. \end{aligned}$$

Clearly,

$$\begin{aligned} \psi(x) &= \frac{1}{\sqrt{2}} (\phi_{\mathbb{R}}(x) + i\phi_{\mathbb{I}}(x)), & \psi^*(x) &= \frac{1}{\sqrt{2}} (\phi_{\mathbb{R}}(x) - i\phi_{\mathbb{I}}(x)), \\ \eta(x) &= \frac{1}{\sqrt{2}} (\pi_{\mathbb{R}}(x) + i\pi_{\mathbb{I}}(x)), & \eta^*(x) &= \frac{1}{\sqrt{2}} (\pi_{\mathbb{R}}(x) - i\pi_{\mathbb{I}}(x)). \end{aligned}$$

Note that

$$\psi(t, \vec{x}) = \int \dot{D}(t, \vec{x} - \vec{y}) \psi(0, \vec{y}) d\vec{y} + \int D(t, \vec{x} - \vec{y}) \eta(0, \vec{y}) d\vec{y}. \quad (5.8)$$

The only non-vanishing equal-time Poisson brackets are

$$\{\psi(t, \vec{x}), \eta^*(t, \vec{y})\} = \{\psi^*(t, \vec{x}), \eta(t, \vec{y})\} = \delta(\vec{x} - \vec{y}). \quad (5.9)$$

Using (5.8) we obtain

$$\begin{aligned} \{\psi(x), \psi(y)\} &= \{\psi^*(x), \psi^*(y)\} = 0, \\ \{\psi(x), \psi^*(y)\} &= D(x - y). \end{aligned}$$

5.1.2 Smeared fields

We can use the symplectic form to pair distributions and solutions. For $\zeta \in \mathcal{W}_{\text{KG}}$ the corresponding *spatially smeared fields* are the functionals on \mathcal{W}_{KG} given by

$$\begin{aligned} \langle \psi((\zeta)) | \rho \rangle &:= \frac{1}{\sqrt{2}} \bar{\zeta} \omega \rho, \\ \langle \psi^*((\zeta)) | \rho \rangle &:= \frac{1}{\sqrt{2}} \zeta \omega \bar{\rho}, \quad \rho \in \mathcal{W}_{\text{KG}}. \end{aligned}$$

Equivalently,

$$\begin{aligned}\psi((\zeta)) &= \int \left(-\overline{\dot{\zeta}(t, \vec{x})} \psi(t, \vec{x}) + \overline{\zeta(t, \vec{x})} \eta(t, \vec{x}) \right) d\vec{x}, \\ \psi^*((\zeta)) &= \int \left(-\dot{\zeta}(t, \vec{x}) \psi^*(t, \vec{x}) + \zeta(t, \vec{x}) \eta^*(t, \vec{x}) \right) d\vec{x}.\end{aligned}$$

Note that

$$\begin{aligned}\{\psi((\zeta_1)), \psi((\zeta_2))\} &= \{\psi^*((\zeta_1)), \psi^*((\zeta_2))\} = 0, \\ \{\psi((\zeta_1)), \psi^*((\zeta_2))\} &= \overline{\zeta_1} \omega \zeta_2.\end{aligned}$$

We can also introduce *space-time smeared fields*. To a space-time function $f \in C_c^\infty(\mathbb{R}^{1,3}, \mathbb{C})$ we associate

$$\begin{aligned}\psi[f] &:= \int \overline{f(x)} \psi(x) dx, \\ \psi^*[f] &:= \int f(x) \psi^*(x) dx.\end{aligned}$$

Clearly,

$$\begin{aligned}\{\psi[f_1], \psi[f_2]\} &= \{\psi^*[f_1], \psi^*[f_2]\} = 0, \\ \{\psi[f_1], \psi^*[f_2]\} &= \int \int \overline{f_1(x)} D(x-y) f_2(y) dx dy, \\ \psi[f] &= -\psi((D * f)), \quad \psi^*[f] = -\psi^*((D * f)).\end{aligned}$$

5.1.3 Lagrangian formalism

In the Lagrangian formalism we use the complex off-shell fields $\psi(x)$ and $\psi^*(x)$ as the basic variables. We introduce the Lagrangian density

$$\mathcal{L}(x) = -\partial_\mu \psi^*(x) \partial^\mu \psi(x) - m^2 \psi^*(x) \psi(x).$$

The Euler-Lagrange equations

$$\partial_{\psi^*} \mathcal{L} - \partial_\mu \frac{\partial \mathcal{L}}{\partial \psi_{,\mu}^*} = 0, \quad \partial_\psi \mathcal{L} - \partial_\mu \frac{\partial \mathcal{L}}{\partial \psi_{,\mu}} = 0 \quad (5.10)$$

yield (5.1). The *variables conjugate* to $\psi(x)$ and $\psi^*(x)$ are

$$\begin{aligned}\eta^*(x) &:= \frac{\partial \mathcal{L}}{\partial \psi_{,0}(x)} = \partial_0 \psi^*(x), \\ \eta(x) &:= \frac{\partial \mathcal{L}}{\partial \psi_{,0}^*(x)} = \partial_0 \psi(x).\end{aligned}$$

5.1.4 Classical 4-current

The Lagrangian is invariant w.r.t. the $U(1)$ symmetry $\psi \mapsto e^{-i\theta}\psi$. The Noether 4-current associated to this symmetry is called simply the *4-current*. It is

$$\begin{aligned}\mathcal{J}^\mu(x) &:= i\left(\psi^*(x)\frac{\partial\mathcal{L}(x)}{\partial\psi_{,\mu}^*} - \frac{\partial\mathcal{L}(x)}{\partial\psi_{,\mu}}\psi(x)\right) \\ &= i\left(\partial^\mu\psi^*(x)\psi(x) - \psi^*(x)\partial^\mu\psi(x)\right).\end{aligned}$$

It is conserved on shell and real:

$$\begin{aligned}\partial_\mu\mathcal{J}^\mu(x) &= 0, \\ \mathcal{J}^\mu(x)^* &= \mathcal{J}^\mu(x).\end{aligned}$$

Up to a coefficient, it coincides with (5.4) viewed as a quadratic form:

$$\begin{aligned}\langle\mathcal{J}^\mu(x)|\zeta\rangle &= \frac{i}{2}j^\mu(\bar{\zeta}, \zeta, x) \\ &= \frac{i}{2}\left(\overline{\partial^\mu\zeta(x)}\zeta(x) - \bar{\zeta}(x)\partial^\mu\zeta(x)\right).\end{aligned}$$

The 0th component of the 4-current is called the *charge density*

$$\mathcal{Q}(x) := \mathcal{J}^0(x) = i(-\eta^*(x)\psi(x) + \psi^*(x)\eta(x)).$$

We have the relations

$$\begin{aligned}\{\mathcal{Q}(t, \vec{x}), \psi(t, \vec{y})\} &= i\psi(t, \vec{y})\delta(\vec{x} - \vec{y}), \\ \{\mathcal{Q}(t, \vec{x}), \eta(t, \vec{y})\} &= i\eta(t, \vec{y})\delta(\vec{x} - \vec{y}), \\ \{\mathcal{Q}(t, \vec{x}), \mathcal{Q}(t, \vec{y})\} &= 0.\end{aligned}\tag{5.11}$$

The *(total) charge*

$$Q := \int \mathcal{Q}(t, \vec{x})d\vec{x}$$

is conserved (does not depend on time).

For $\chi \in C_c^\infty(\mathbb{R}^3, \mathbb{R})$, let α_χ denote the $*$ -automorphism of the algebra of functions on \mathcal{W}_{KG} defined by

$$\begin{aligned}\alpha_\chi(\psi(0, \vec{x})) &:= e^{-i\chi(\vec{x})}\psi(0, \vec{x}), \\ \alpha_\chi(\eta(0, \vec{x})) &:= e^{-i\chi(\vec{x})}\eta(0, \vec{x}).\end{aligned}\tag{5.12}$$

Obviously,

$$\begin{aligned}\alpha_\chi(\psi^*(0, \vec{x})) &= e^{i\chi(\vec{x})}\psi^*(0, \vec{x}), \\ \alpha_\chi(\eta^*(0, \vec{x})) &= e^{i\chi(\vec{x})}\eta^*(0, \vec{x}).\end{aligned}\tag{5.13}$$

(5.12) is called the *gauge transformation* at time $t = 0$ corresponding to χ . Set

$$Q(\chi) = \int \chi(\vec{x})\mathcal{Q}(0, \vec{x})d\vec{x}.\tag{5.14}$$

$Q(\chi)$ generates the one-parameter group of gauge transformations $\mathbb{R} \ni s \mapsto \alpha_{s\chi}$ (5.12). In other words, for any classical observable B (a function on \mathcal{W}_{KG})

$$\begin{aligned}\partial_s \alpha_{s\chi}(B) &= \{\alpha_{s\chi}(B), Q(\chi)\}, \\ \alpha_{0\chi}(B) &= B.\end{aligned}$$

5.1.5 Stress-energy tensor

The Lagrangian is invariant w.r.t. space-time translations. This leads to the *stress-energy tensor*

$$\begin{aligned}\mathcal{T}^{\mu\nu}(x) &:= -\frac{\partial \mathcal{L}(x)}{\partial \psi_{,\mu}(x)} \partial^\nu \psi(x) - \partial^\nu \psi^*(x) \frac{\partial \mathcal{L}(x)}{\partial \psi^*_{,\mu}(x)} + g^{\mu\nu} \mathcal{L}(x) \\ &= \partial^\mu \psi^*(x) \partial^\nu \psi(x) + \partial^\nu \psi^*(x) \partial^\mu \psi(x) \\ &\quad - g^{\mu\nu} (\partial_\alpha \psi^*(x) \partial^\alpha \psi(x) + m^2 \psi^*(x) \psi(x)).\end{aligned}$$

It is conserved on shell

$$\partial_\mu \mathcal{T}^{\mu\nu}(x) = 0.$$

The components of the stress-energy tensor with the first temporal coordinate are called the Hamiltonian density and momentum density. We express them on-shell in terms of $\psi(x)$, $\psi^*(x)$, $\eta(x)$ and $\eta^*(x)$:

$$\begin{aligned}\mathcal{H}(x) &:= \mathcal{T}^{00}(x) = \eta^*(x) \eta(x) + \vec{\partial} \psi^*(x) \vec{\partial} \psi(x) + m^2 \psi^*(x) \psi(x), \\ \mathcal{P}^i(x) &:= \mathcal{T}^{0i}(x) = -\eta^*(x) \partial^i \psi(x) - \partial^i \psi^*(x) \eta(x).\end{aligned}$$

$\mathcal{H}(x)$ and $\vec{\mathcal{P}}(x)$ acting on $\zeta \in \mathcal{W}_{\text{KG}}$ yield

$$\begin{aligned}\langle \mathcal{H}(x) | \zeta \rangle &= \frac{1}{2} |\dot{\zeta}(x)|^2 + \frac{1}{2} |\vec{\partial} \zeta(x)|^2 + \frac{m^2}{2} |\zeta(x)|^2, \\ \langle \vec{\mathcal{P}}(x) | \zeta \rangle &= -\frac{1}{2} \overline{\dot{\zeta}(x)} \vec{\partial} \zeta(x) - \frac{1}{2} \overline{\vec{\partial} \zeta(x)} \dot{\zeta}(x).\end{aligned}$$

We can define the Hamiltonian and momentum

$$H = \int \mathcal{H}(t, \vec{x}) d\vec{x}, \quad \vec{P} = \int \vec{\mathcal{P}}(t, \vec{x}) d\vec{x}.$$

H and \vec{P} are the generators of the time and space translations. The observables H , P_1 , P_2 , P_3 and Q are in involution.

5.1.6 Diagonalization of the equations of motion

Recall that in the neutral case the generic notation for the energy-momentum was k . The on-shell condition was $k^2 + m^2 = 0$, $k^0 > 0$. In other words, $k^0 = \varepsilon(\vec{k}) := \sqrt{\vec{k}^2 + m^2}$.

In the charged case, following [17], it will be convenient to use different letters for the generic notation of the energy-momentum. In the charged case, the

energy-momentum will be denoted generically by p with the on-shell condition $p^2 + m^2 = 0$, $p^0 > 0$. We will also use a different letter for the energy: $E(\vec{p}) := \sqrt{\vec{p}^2 + m^2}$. In other words, $p = (E(\vec{p}), \vec{p})$.

Define

$$\begin{aligned}\psi_t(\vec{p}) &:= \int \psi(t, \vec{x}) e^{-i\vec{p}\vec{x}} d\vec{x}, \\ \eta_t(\vec{p}) &:= \int \eta(t, \vec{x}) e^{-i\vec{p}\vec{x}} d\vec{x}.\end{aligned}$$

Clearly, the only nonvanishing Poisson brackets are

$$\{\psi_t(\vec{p}), \eta_t^*(\vec{p}')\} = \{\psi_t^*(\vec{p}), \eta_t(\vec{p}')\} = (2\pi)^3 \delta(\vec{p} - \vec{p}').$$

The equations of motion are

$$\begin{aligned}\dot{\psi}_t(\vec{p}) &= \eta_t(\vec{p}), \\ \dot{\eta}_t(\vec{p}) &= -E^2(\vec{p})\psi_t(\vec{p}).\end{aligned}$$

For on-shell $p \in \mathbb{R}^{1,3}$ define

$$\begin{aligned}a_t(p) &= \frac{1}{\sqrt{(2\pi)^3}} \left(\sqrt{\frac{E(\vec{p})}{2}} \psi(t, \vec{p}) + \frac{i}{\sqrt{2E(\vec{p})}} \eta(t, \vec{p}) \right), \\ a_t^*(p) &= \frac{1}{\sqrt{(2\pi)^3}} \left(\sqrt{\frac{E(\vec{p})}{2}} \psi^*(t, \vec{p}) - \frac{i}{\sqrt{2E(\vec{p})}} \eta^*(t, \vec{p}) \right), \\ b_t(p) &= \frac{1}{\sqrt{(2\pi)^3}} \left(\sqrt{\frac{E(\vec{p})}{2}} \psi^*(t, \vec{p}) + \frac{i}{\sqrt{2E(\vec{p})}} \eta^*(t, \vec{p}) \right), \\ b_t^*(p) &= \frac{1}{\sqrt{(2\pi)^3}} \left(\sqrt{\frac{E(\vec{p})}{2}} \psi(t, \vec{p}) - \frac{i}{\sqrt{2E(\vec{p})}} \eta(t, \vec{p}) \right).\end{aligned}$$

We have the equations of motion

$$\begin{aligned}\dot{a}_t(p) &= -iE(\vec{p})a_t(p), & \dot{b}_t(p) &= -iE(\vec{p})b_t(p), \\ \dot{a}_t^*(p) &= iE(\vec{p})a_t^*(p), & \dot{b}_t^*(p) &= iE(\vec{p})b_t^*(p).\end{aligned}$$

We will usually write $a(p)$, $a^*(p)$, $b(p)$, $b^*(p)$ instead of $a_0(p)$, $a_0^*(p)$, $b_0(p)$, $b_0^*(p)$, so that

$$\begin{aligned}a(p) &= \int \left(\sqrt{\frac{E(\vec{p})}{2}} \psi(0, \vec{x}) + \frac{i}{\sqrt{2E(\vec{p})}} \eta(0, \vec{x}) \right) e^{-i\vec{p}\vec{x}} \frac{d\vec{x}}{\sqrt{(2\pi)^3}}, \\ a^*(p) &= \int \left(\sqrt{\frac{E(\vec{p})}{2}} \psi^*(0, \vec{x}) - \frac{i}{\sqrt{2E(\vec{p})}} \eta^*(0, \vec{x}) \right) e^{i\vec{p}\vec{x}} \frac{d\vec{x}}{\sqrt{(2\pi)^3}}, \\ b(p) &= \int \left(\sqrt{\frac{E(\vec{p})}{2}} \psi^*(0, \vec{x}) + \frac{i}{\sqrt{2E(\vec{p})}} \eta^*(0, \vec{x}) \right) e^{-i\vec{p}\vec{x}} \frac{d\vec{x}}{\sqrt{(2\pi)^3}}, \\ b^*(p) &= \int \left(\sqrt{\frac{E(\vec{p})}{2}} \psi(0, \vec{x}) - \frac{i}{\sqrt{2E(\vec{p})}} \eta(0, \vec{x}) \right) e^{i\vec{p}\vec{x}} \frac{d\vec{x}}{\sqrt{(2\pi)^3}},\end{aligned}$$

$$\begin{aligned} a_t(p) &= e^{-itE(\vec{p})} a(p), & b_t(p) &= e^{-itE(\vec{p})} b(p), \\ a_t^*(p) &= e^{itE(\vec{p})} a^*(p), & b_t^*(p) &= e^{itE(\vec{p})} b^*(p). \end{aligned}$$

The only non-vanishing Poisson bracket are

$$\{a(p), a^*(p')\} = \{b(p), b^*(p')\} = -i\delta(\vec{p} - \vec{p}').$$

We have the following expressions for the fields:

$$\begin{aligned} \psi(x) &= \int \frac{d\vec{p}}{\sqrt{(2\pi)^3} \sqrt{2E(\vec{p})}} (e^{ipx} a(p) + e^{-ipx} b^*(p)), \\ \eta(x) &= \int \frac{d\vec{p} \sqrt{E(\vec{p})}}{i\sqrt{(2\pi)^3} \sqrt{2}} (e^{ipx} a(p) - e^{-ipx} b^*(p)). \end{aligned}$$

We have accomplished the diagonalization of the basic observables:

$$\begin{aligned} H &= \int d\vec{p} E(\vec{p}) (a^*(p)a(p) + b^*(p)b(p)), \\ \vec{P} &= \int d\vec{p} \vec{p} (a^*(p)a(p) + b^*(p)b(p)), \\ Q &= \int d\vec{p} (a^*(p)a(p) - b^*(p)b(p)). \end{aligned}$$

Every $\zeta \in \mathcal{W}_{\text{KG}}$ can be written as

$$\zeta(x) = \int \frac{d\vec{p}}{\sqrt{(2\pi)^3} \sqrt{E(\vec{p})}} (e^{ipx} \langle a(p) | \zeta \rangle + e^{-ipx} \langle b^*(p) | \zeta \rangle). \quad (5.15)$$

Note that the plane wave functional $a(k)$ of the neutral case is slightly different from its counterpart $a(p)$ of the charged case. The former acts on the real space \mathcal{Y}_{KG} and the latter on the complex space \mathcal{W}_{KG} , but the latter is not simply the complexification of the former – compare (2.33) and (5.15) and notice the absence of $\sqrt{2}$.

5.1.7 Plane waves

In the charged case we use almost the same plane waves as those introduced in the neutral case in (2.30). There are three differences: the generic notation for the energy-momentum is now p , plane waves with a negative frequency p^0 are now on the equal footing as those with a positive frequency, and there is a factor $\sqrt{2}$ is missing in the denominator. Thus for $p \in \mathbb{R}^{1,3}$ with $p^2 + m^2 = 0$ we define

$$(x|p) = \frac{1}{\sqrt{(2\pi)^3} \sqrt{E(\vec{p})}} e^{ipx}. \quad (5.16)$$

Let $p^0, p^{0'} > 0$. We have

$$\begin{aligned} i(-p|\omega|p') &= i(-p|\omega|p') = 0, \\ -i(-p|\omega| - p') &= i(p|\omega|p') = 2\delta(\vec{p} - \vec{p}'). \end{aligned}$$

$a(p)$ and $b(p)$ can be called *plane wave functionals*:

$$\begin{aligned} a(p) &= \frac{i}{\sqrt{2}}\psi(|p\rangle), \\ b^*(p) &= -\frac{i}{\sqrt{2}}\psi(|-p\rangle). \end{aligned}$$

Thus for every $\zeta \in \mathcal{W}_{\text{KG}}$ we have

$$\langle a(p)|\zeta \rangle = \frac{i}{2}(p|\omega\zeta, \quad (5.17)$$

$$\langle b^*(p)|\zeta \rangle = -\frac{i}{2}(-p|\omega\zeta. \quad (5.18)$$

5.1.8 Positive and negative frequency subspace

When we discussed neutral scalar fields we introduced *positive/negative frequency spaces*, which in the notation used in the charged case can be defined by

$$\begin{aligned} \mathcal{W}_{\text{KG}}^{(+)} &:= \{g \in \mathbb{C}\mathcal{Y}_{\text{KG}} : (p|\omega g = 0, \quad p^0 < 0\}, \\ \mathcal{W}_{\text{KG}}^{(-)} &:= \overline{\mathcal{W}_{\text{KG}}^{(+)}} = \{g \in \mathbb{C}\mathcal{Y}_{\text{KG}} : (p|\omega g = 0, \quad p^0 > 0\}. \end{aligned}$$

Every $\zeta \in \mathcal{W}_{\text{KG}}$ can be uniquely decomposed as $\zeta = \zeta^{(+)} + \zeta^{(-)}$ with $\zeta^{(\pm)} \in \mathcal{W}_{\text{KG}}^{(\pm)}$.

We equip $\mathcal{W}_{\text{KG}}^{(+)}$ with the scalar product

$$(\zeta_1^{(+)}|\zeta_2^{(+)}) := \frac{i}{2}\overline{\zeta_1^{(+)}}\omega\zeta_2^{(+)} = \int \overline{\langle a(p)|\zeta_1^{(+)} \rangle} \langle a(p)|\zeta_2^{(+)} \rangle d\vec{p}. \quad (5.19)$$

We set $\mathcal{Z}_{\text{KG}}^{(+)}$ to be the completion of $\mathcal{W}_{\text{KG}}^{(+)}$ in this scalar product. By (5.17),

$$\langle a(p)|\zeta^{(+)} \rangle = (p|\zeta^{(+)}).$$

$\mathcal{Z}_{\text{KG}}^{(+)}$ can be identified with $L^2(\mathbb{R}^3)$ and (5.19) rewritten as

$$(\zeta_1^{(+)}|\zeta_2^{(+)}) = \int \overline{(p|\zeta_1^{(+)})} (p|\zeta_2^{(+)}) d\vec{p}.$$

Instead of $\mathcal{W}_{\text{KG}}^{(-)}$ for quantization we will use the corresponding complex conjugate space denoted $\overline{\mathcal{W}_{\text{KG}}^{(-)}}$ and equipped with the scalar product

$$(\overline{\zeta_1^{(-)}}|\overline{\zeta_2^{(-)}}) := \frac{i}{2}\zeta_1^{(-)}\omega\overline{\zeta_2^{(-)}} = \int \overline{\langle b(p)|\zeta_1^{(-)} \rangle} \langle b(p)|\zeta_2^{(-)} \rangle d\vec{p}. \quad (5.20)$$

We set $\mathcal{Z}_{\text{KG}}^{(-)}$ to be the completion of $\overline{\mathcal{W}_{\text{KG}}^{(-)}}$ in this scalar product. By (5.18),

$$\langle b(p)|\zeta^{(-)} \rangle = (\overline{-p}|\overline{\zeta^{(-)}}).$$

$\mathcal{Z}_{\text{KG}}^{(-)}$ can be identified with $L^2(\mathbb{R}^3)$ and (5.20) rewritten as

$$(\bar{\zeta}_1^{(-)} | \bar{\zeta}_2^{(-)}) = \int \overline{(-p | \bar{\zeta}_1^{(-)})} (-p | \bar{\zeta}_2^{(-)}) d\vec{p}.$$

Note that $\overline{\mathcal{W}_{\text{KG}}^{(-)}} = \mathcal{W}_{\text{KG}}^{(+)}$, where we use the usual (internal) complex conjugation in \mathcal{W}_{KG} . Therefore in principle we could identify $\mathcal{Z}_{\text{KG}}^{(-)}$ and $\mathcal{Z}_{\text{KG}}^{(+)}$. This identification will be important for the definition of the charge conjugation. Normally, however, we treat $\mathcal{Z}_{\text{KG}}^{(-)}$ and $\mathcal{Z}_{\text{KG}}^{(+)}$ as two separate Hilbert spaces.

$\mathbb{R}^{1,3} \rtimes O^\uparrow(1,3)$ acts on $\mathcal{Z}_{\text{KG}}^{(+)}$ and $\mathcal{Z}_{\text{KG}}^{(-)}$ in a natural way.

5.1.9 Quantization

In principle, we could quantize the complex Klein-Gordon equation as a pair of real Klein-Gordon fields. However, we will use the formalism of quantization of charged bosonic systems [15].

We want to construct $(\mathcal{H}, \hat{H}, \Omega)$ satisfying the usual requirements of QM (1)-(3) and an operator valued distribution

$$\mathbb{R}^{1,3} \ni x \mapsto \hat{\psi}(x) \tag{5.21}$$

satisfying, with $\eta(x) := \dot{\psi}(x)$,

- (1) $(-\square + m^2)\hat{\psi}(x) = 0$;
- (2) the only non-vanishing 0-time commutators are

$$[\hat{\psi}(0, \vec{x}), \hat{\eta}^*(0, \vec{y})] = i\delta(\vec{x} - \vec{y}), \quad [\hat{\psi}^*(0, \vec{x}), \hat{\eta}(0, \vec{y})] = i\delta(\vec{x} - \vec{y}); \tag{5.22}$$

- (3) $e^{it\hat{H}}\hat{\psi}(x^0, \vec{x})e^{-it\hat{H}} = \hat{\psi}(x^0 + t, \vec{x})$;
- (4) Ω is cyclic for $\hat{\psi}(x)$, $\hat{\psi}^*(x)$.

The above problem has an essentially unique solution, which we describe below.

We set

$$\mathcal{H} := \Gamma_{\text{s}}(\mathcal{Z}_{\text{KG}}^{(+)} \oplus \mathcal{Z}_{\text{KG}}^{(-)}).$$

Creation/annihilation operators for the particle space $\mathcal{Z}_{\text{KG}}^{(+)} \simeq L^2(\mathbb{R}^3)$ are denoted with the letter a and for the antiparticle space $\mathcal{Z}_{\text{KG}}^{(-)} \simeq L^2(\mathbb{R}^3)$ with the letter b . Thus, for p on the mass shell, using physicist's notation on the left and mathematician's on the right, creation operators for particles/antiparticles are written as

$$\hat{a}^*(p) = \hat{a}^*(|p\rangle), \tag{5.23}$$

$$\hat{b}^*(p) = \hat{b}^*(\overline{|-p\rangle}). \tag{5.24}$$

Ω is the Fock vacuum. The quantum field is

$$\begin{aligned}\hat{\psi}(x) &:= \int \frac{d\vec{p}}{\sqrt{(2\pi)^3} \sqrt{2E(\vec{p})}} \left(e^{ipx} \hat{a}(p) + e^{-ipx} \hat{b}^*(p) \right), \\ \hat{\eta}(x) &:= \int \frac{d\vec{p} \sqrt{E(\vec{p})}}{i \sqrt{(2\pi)^3} \sqrt{2}} \left(e^{ipx} \hat{a}(p) - e^{-ipx} \hat{b}^*(p) \right).\end{aligned}$$

The quantum Hamiltonian, momentum and charge are

$$\begin{aligned}\hat{H} &:= \int \left(\hat{a}^*(p) \hat{a}(p) + \hat{b}^*(p) \hat{b}(p) \right) E(\vec{p}) d\vec{p}, \\ \vec{\hat{P}} &:= \int \left(\hat{a}^*(p) \hat{a}(p) + \hat{b}^*(p) \hat{b}(p) \right) \vec{p} d\vec{p}, \\ \hat{Q} &:= \int \left(\hat{a}^*(p) \hat{a}(p) - \hat{b}^*(p) \hat{b}(p) \right) d\vec{p}.\end{aligned}\tag{5.25}$$

Equivalently, for any t

$$\begin{aligned}\hat{H} &= \int : \left(\hat{\eta}^*(t, \vec{x}) \hat{\eta}(t, \vec{x}) + \vec{\partial} \hat{\psi}^*(t, \vec{x}) \vec{\partial} \hat{\psi}(t, \vec{x}) + m^2 \hat{\psi}^*(t, \vec{x}) \hat{\psi}(t, \vec{x}) \right) : d\vec{x}, \\ \vec{\hat{P}} &= \int : \left(-\hat{\eta}^*(t, \vec{x}) \vec{\partial} \hat{\psi}(t, \vec{x}) - \vec{\partial} \hat{\psi}^*(t, \vec{x}) \hat{\eta}(t, \vec{x}) \right) : d\vec{x}, \\ \hat{Q} &= i \int : \left(-\hat{\eta}^*(t, \vec{x}) \hat{\psi}(t, \vec{x}) + \hat{\psi}^*(t, \vec{x}) \hat{\eta}(t, \vec{x}) \right) : d\vec{x}.\end{aligned}$$

Thus all these operators are expressed in terms of the Wick quantization of their classical expressions.

Note that the whole group $\mathbb{R}^{1,3} \times O^\uparrow(1, 3)$ acts unitarily on \mathcal{H} by $U(y, \Lambda) := \Gamma\left(r_{(y, \Lambda)} \Big|_{\mathcal{Z}_{\text{KG}}^{(+)}}\right) \otimes \Gamma\left(\bar{r}_{(y, \Lambda)} \Big|_{\mathcal{Z}_{\text{KG}}^{(-)}}\right)$, with

$$U(y, \Lambda) \hat{\psi}(x) U(y, \Lambda)^* = \hat{\psi}((y, \Lambda)x).$$

Moreover,

$$[\hat{\psi}(x), \hat{\psi}^*(y)] = -iD(x-y), \quad [\hat{\psi}(x), \hat{\psi}(y)] = 0.$$

Note the identities

$$\begin{aligned}(\Omega | \hat{\psi}(x) \hat{\psi}^*(y) \Omega) &= -iD^{(+)}(x-y), \\ (\Omega | \Gamma(\hat{\psi}(x) \hat{\psi}^*(y)) \Omega) &= -iD^c(x-y).\end{aligned}$$

For $f \in C_c^\infty(\mathbb{R}^{1,3}, \mathbb{C})$ we set

$$\begin{aligned}\hat{\psi}[f] &:= \int \overline{f(x)} \hat{\psi}(x) dx, \\ \hat{\psi}^*[f] &:= \int f(x) \hat{\psi}^*(x) dx.\end{aligned}$$

We obtain an operator valued distribution satisfying the Wightman axioms with $\mathcal{D} := \Gamma_s^{\text{fin}}(\mathcal{Z}_{\text{KG}}^{(+)} \oplus \mathcal{Z}_{\text{KG}}^{(-)})$.

For an open set $\mathcal{O} \subset \mathbb{R}^{1,3}$ the field algebra is defined as

$$\mathfrak{F}(\mathcal{O}) := \left\{ \exp \left(i\hat{\psi}^*[f] + i\hat{\psi}[f] \right) : f \in C_c^\infty(\mathcal{O}, \mathbb{C}) \right\}''.$$

The observable algebra $\mathfrak{A}(\mathcal{O})$ is the subalgebra of $\mathfrak{F}(\mathcal{O})$ fixed by the automorphism

$$B \mapsto e^{i\theta\hat{Q}} B e^{-i\theta\hat{Q}}.$$

The algebras $\mathfrak{F}(\mathcal{O})$ and $\mathfrak{A}(\mathcal{O})$ satisfy the *Haag-Kastler axioms*.

5.1.10 Quantum 4-current

Let us try to introduce the (*quantum*) 4-current density by

$$\begin{aligned} \hat{\mathcal{J}}^\mu(x) &= \frac{i}{2} \left(\partial^\mu \hat{\psi}^*(x) \hat{\psi}(x) + \hat{\psi}(x) \partial^\mu \hat{\psi}^*(x) \right. \\ &\quad \left. - \hat{\psi}^*(x) \partial^\mu \hat{\psi}(x) - \partial^\mu \hat{\psi}(x) \hat{\psi}^*(x) \right). \end{aligned} \quad (5.26)$$

In Subsect. 5.2.6 later on we will introduce a certain unitary operator C called the charge conjugation satisfying $C\Omega = \Omega$, $C\hat{\mathcal{J}}^\mu(x)C^{-1} = -\hat{\mathcal{J}}^\mu(x)$. The existence of such C implies

$$(\Omega | \hat{\mathcal{J}}^\mu(x) \Omega) = 0.$$

Therefore, (5.26) can be replaced with the following equivalent definition:

$$\hat{\mathcal{J}}^\mu(x) = i: \left(\partial^\mu \hat{\psi}^*(x) \hat{\psi}(x) - \hat{\psi}^*(x) \partial^\mu \hat{\psi}(x) \right):. \quad (5.27)$$

Thus $\hat{\mathcal{J}}^\mu(x)$ can be defined both as the Weyl quantization (5.26) and the Wick quantization (5.27) of the corresponding quadratic classical expression.

Formally, we can check the relations

$$\begin{aligned} \partial^\mu \hat{\mathcal{J}}_\mu(x) &= 0, \\ \hat{\mathcal{J}}^\mu(x)^* &= \hat{\mathcal{J}}^\mu(x). \end{aligned}$$

In particular, we have the (*quantum*) charge density

$$\hat{\mathcal{Q}}(x) := \hat{\mathcal{J}}^0(x) = i: (-\hat{\eta}^*(x) \hat{\psi}(x) + \hat{\psi}^*(x) \hat{\eta}(x)):$$

with the relations

$$\begin{aligned} [\hat{\mathcal{Q}}(t, \vec{x}), \hat{\psi}(t, \vec{y})] &= -\hat{\psi}(t, \vec{y}) \delta(\vec{x} - \vec{y}), \\ [\hat{\mathcal{Q}}(t, \vec{x}), \hat{\eta}(t, \vec{y})] &= -\hat{\eta}(t, \vec{y}) \delta(\vec{x} - \vec{y}), \\ [\hat{\mathcal{Q}}(t, \vec{x}), \hat{\mathcal{Q}}(t, \vec{y})] &= 0. \end{aligned} \quad (5.28)$$

Similarly, as in the classical case, for $\chi \in C_c^\infty(\mathbb{R}^3, \mathbb{R})$, let α_χ denote the corresponding *gauge transformation at time $t = 0$* defined as the $*$ -automorphism of the algebra generated by the fields operators satisfying

$$\begin{aligned}\alpha_\chi(\hat{\psi}(0, \vec{x})) &:= e^{-i\chi(\vec{x})}\hat{\psi}(0, \vec{x}), \\ \alpha_\chi(\hat{\eta}(0, \vec{x})) &:= e^{-i\chi(\vec{x})}\hat{\eta}(0, \vec{x}).\end{aligned}\tag{5.29}$$

Obviously,

$$\begin{aligned}\alpha_\chi(\hat{\psi}^*(0, \vec{x})) &= e^{i\chi(\vec{x})}\hat{\psi}^*(0, \vec{x}), \\ \alpha_\chi(\hat{\eta}^*(0, \vec{x})) &= e^{i\chi(\vec{x})}\hat{\eta}^*(0, \vec{x}).\end{aligned}\tag{5.30}$$

Assume that $\chi \neq 0$. Let us check whether α_χ is unitarily implementable. On the level of annihilation operators we have

$$\begin{aligned}\alpha_\chi(\hat{a}(p)) &= \int \int \left(\sqrt{\frac{E(\vec{p}_1)}{E(\vec{p})}} + \sqrt{\frac{E(\vec{p})}{E(\vec{p}_1)}} \right) \frac{d\vec{x}d\vec{p}_1}{2(2\pi)^3} e^{i(\vec{p}_1 - \vec{p})\vec{x} - ie\chi(\vec{x})} \hat{a}(p_1) \\ &\quad + \int \int \left(\sqrt{\frac{E(\vec{p}_1)}{E(\vec{p})}} - \sqrt{\frac{E(\vec{p})}{E(\vec{p}_1)}} \right) \frac{d\vec{x}d\vec{p}_1}{2(2\pi)^3} e^{-i(\vec{p}_1 + \vec{p})\vec{x} - ie\chi(\vec{x})} \hat{b}^*(p_1).\end{aligned}$$

Let $q_\chi(\vec{p}, \vec{p}_1)$ denote the integral kernel on the second line above. By the Shale criterion (Thm A.2), we need to check whether it is square integrable. Now

$$\begin{aligned}&\left(\sqrt{\frac{E(\vec{p}_1)}{E(\vec{p})}} - \sqrt{\frac{E(\vec{p})}{E(\vec{p}_1)}} \right) \\ &= \frac{(|\vec{p}_1| - |\vec{p}|)(|\vec{p}_1| + |\vec{p}|)}{(E(\vec{p}) + E(\vec{p}_1))\sqrt{E(\vec{p})E(\vec{p}_1)}}.\end{aligned}\tag{5.31}$$

After integrating in \vec{x} we obtain fast decay of q_χ in $\vec{p} + \vec{p}_1$, which in particular allows us to control the term $|\vec{p}_1| - |\vec{p}|$. We obtain

$$\int |q(\vec{p}, \vec{p}_1)|^2 d\vec{p} \sim \frac{C}{E(\vec{p}_1)^2},$$

which is not integrable. Thus α_χ is not implementable.

Formally, if we set

$$\hat{Q}(\chi) := \int \chi(\vec{x}) \hat{Q}(0, \vec{x}) d\vec{x},\tag{5.32}$$

then $e^{ie\hat{Q}(\chi)}$ implements the gauge transformation:

$$\alpha_\chi(\hat{B}) = e^{ie\hat{Q}(\chi)} \hat{B} e^{-ie\hat{Q}(\chi)}.$$

But we know that α_χ is not implementable. Thus for nonzero χ (5.32) cannot be defined as a closable operator.

However, the (*quantum*) charge

$$\hat{Q} = \int \hat{Q}(t, \vec{x}) d\vec{x},$$

as we have already seen, is a well defined operator.

For further reference let us express the charge and current density in terms of creation and annihilation operators:

$$\begin{aligned} \hat{Q}(x) &= \int \int \frac{d\vec{p}_1 d\vec{p}_2}{2(2\pi)^3} \left(\sqrt{\frac{E(\vec{p}_1)}{E(\vec{p}_2)}} + \sqrt{\frac{E(\vec{p}_2)}{E(\vec{p}_1)}} \right) \\ &\quad \times \left(e^{-ixp_1 + ixp_2} \hat{a}^*(p_1) \hat{a}(p_2) - e^{ixp_1 - ixp_2} \hat{b}^*(p_2) \hat{b}(p_1) \right) \\ &\quad + \int \int \frac{d\vec{p}_1 d\vec{p}_2}{2(2\pi)^3} \left(\sqrt{\frac{E(\vec{p}_1)}{E(\vec{p}_2)}} - \sqrt{\frac{E(\vec{p}_2)}{E(\vec{p}_1)}} \right) \\ &\quad \times \left(-e^{-ixp_1 - ixp_2} \hat{a}^*(p_1) \hat{b}^*(p_2) + e^{ixp_1 + ixp_2} \hat{b}(p_1) \hat{a}(p_2) \right), \\ \vec{\mathcal{J}}(x) &= \int \int \frac{d\vec{p}_1 d\vec{p}_2}{2(2\pi)^3 \sqrt{E(\vec{p}_1)E(\vec{p}_2)}} (\vec{p}_1 + \vec{p}_2) \\ &\quad \times \left(-e^{-ixp_1 + ixp_2} \hat{a}^*(p_1) \hat{a}(p_2) + e^{ixp_1 - ixp_2} \hat{b}^*(p_2) \hat{b}(p_1) \right) \\ &\quad + \int \int \frac{d\vec{p}_1 d\vec{p}_2}{2(2\pi)^3 \sqrt{E(\vec{p}_1)E(\vec{p}_2)}} (\vec{p}_1 - \vec{p}_2) \\ &\quad \times \left(-e^{-ixp_1 - ixp_2} \hat{a}^*(p_1) \hat{b}^*(p_2) + e^{ixp_1 + ixp_2} \hat{b}(p_1) \hat{a}(p_2) \right). \end{aligned}$$

5.1.11 Quantization in terms of smeared fields

An alternative equivalent formulation of the quantization program uses smeared fields instead of point fields. Instead of (2.38) we look for an antilinear function

$$\mathcal{W}_{\text{KG}} \ni \zeta \mapsto \hat{\psi}((\zeta))$$

with values in closed operators such that

- (1) $[\hat{\psi}((\zeta_1)), \hat{\psi}^*((\zeta_2))] = i\bar{\zeta}_1 \omega \zeta_2, \quad [\hat{\psi}((\zeta_1)), \hat{\psi}((\zeta_2))] = 0.$
- (2) $\hat{\psi}((r_{(t, \vec{0})} \zeta)) = e^{it\hat{H}} \hat{\psi}((\zeta)) e^{-it\hat{H}}.$
- (3) Ω is cyclic for the algebra generated by $\psi((\zeta)), \psi^*((\zeta)).$

One can pass between these two versions of the quantization by

$$\hat{\psi}((\zeta)) = \int \left(-\overline{\zeta(t, \vec{x})} \hat{\psi}(t, \vec{x}) + \overline{\zeta(t, \vec{x})} \hat{\eta}(t, \vec{x}) \right) d\vec{x}. \quad (5.33)$$

5.2 Charged scalar bosons in an external 4-potential

5.2.1 Classical fields

Let us go back to the classical theory. Let

$$\mathbb{R}^{1,3} \ni x \mapsto A(x) = [A^\mu(x)] \in \mathbb{R}^{1,3} \quad (5.34)$$

be a given function called the (*external electromagnetic*) 4-potential. In most of this subsection we will assume that (5.34) is Schwartz. The (complex) Klein-Gordon equation in the external 4-potential A is

$$(-\partial_\mu + ieA_\mu(x))(\partial^\mu + ieA^\mu(x) + m^2)\psi(x) = 0. \quad (5.35)$$

If ψ satisfies (5.35) and $\mathbb{R}^{1,3} \ni x \mapsto \chi(x) \in \mathbb{R}$ is smooth, then $e^{-ie\chi}\psi$ satisfies (5.35) with A replaced with $A + \partial\chi$.

In this subsection, the field satisfying the Klein-Gordon equation with $A = 0$ will be denoted ψ_{fr} .

The retarded/advanced Green's function is defined as the unique solution of

$$(-\partial_\mu + ieA_\mu(x))(\partial^\mu + ieA^\mu(x) + m^2)D^\pm(x, y) = \delta(x - y) \quad (5.36)$$

satisfying

$$\text{supp}D^\pm \subset \{x, y : x \in J^\pm(y)\}.$$

We generalize the Pauli-Jordan function:

$$D(x, y) := D^+(x, y) - D^-(x, y).$$

Clearly,

$$\text{supp}D \subset \{x, y : x \in J(y)\}.$$

The *Cauchy problem* of (5.35) can be expressed with help of the function D :

$$\begin{aligned} \psi(t, \vec{x}) &= - \int_{\mathbb{R}^3} \partial_s D(t, \vec{x}; s, \vec{y}) \Big|_{s=0} \psi(0, \vec{y}) d\vec{y} \\ &+ \int_{\mathbb{R}^3} D(t, \vec{x}; 0, \vec{y}) \dot{\psi}(0, \vec{y}) d\vec{y}. \end{aligned} \quad (5.37)$$

We would like to introduce a field $\mathbb{R}^{1,3} \ni x \mapsto \psi(x)$ satisfying (5.35). As we will see shortly, the conjugate field is

$$\eta(x) := \partial_0 \psi(x) + ieA_0(x)\psi(x).$$

For definiteness, we will assume that $\psi(x), \eta(x)$ act on \mathcal{W}_{KG} and at time $t = 0$ coincide with free fields:

$$\begin{aligned} \psi(0, \vec{x}) &= \psi_{\text{fr}}(0, \vec{x}), \\ \eta(0, \vec{x}) &= \eta_{\text{fr}}(0, \vec{x}). \end{aligned}$$

This determines the field ψ uniquely:

$$\begin{aligned} \psi(t, \vec{x}) &= - \int_{\mathbb{R}^3} \partial_s D(t, \vec{x}; s, \vec{y}) \Big|_{s=0} \psi_{\text{fr}}(0, \vec{y}) d\vec{y} \\ &+ \int_{\mathbb{R}^3} D(t, \vec{x}; 0, \vec{y}) (\eta_{\text{fr}}(0, \vec{y}) - ieA_0(0, \vec{y})\psi_{\text{fr}}(0, \vec{y})) d\vec{y}. \end{aligned} \quad (5.38)$$

5.2.2 Lagrangian and Hamiltonian formalism

Consider the Lagrangian density

$$\mathcal{L}(x) = -(\partial_\mu - ieA_\mu(x))\psi^*(x)(\partial^\mu + ieA^\mu(x))\psi(x) - m^2\psi^*(x)\psi(x).$$

The Euler-Lagrange equations (5.10) yield (5.35).

Let us introduce the *variable conjugate* to $\psi^*(x)$ and $\psi(x)$:

$$\begin{aligned}\eta(x) &:= \frac{\partial\mathcal{L}}{\partial_0\psi^*(x)} = \partial_0\psi(x) + ieA_0(x)\psi(x), \\ \eta^*(x) &= \frac{\partial\mathcal{L}}{\partial_0\psi(x)} = \partial_0\psi^*(x) - ieA_0(x)\psi^*(x).\end{aligned}$$

We introduce the Hamiltonian density

$$\begin{aligned}\mathcal{H}(x) &= \frac{\partial\mathcal{L}(x)}{\partial\dot{\psi}(x)}\dot{\psi}(x) + \frac{\partial\mathcal{L}(x)}{\partial\dot{\psi}^*(x)}\dot{\psi}^*(x) - \mathcal{L}(x) \\ &= \eta^*(x)\eta(x) + ieA_0(x)(\psi^*(x)\eta(x) - \eta^*(x)\psi(x)) \\ &\quad + (\partial_i - ieA_i(x))\psi^*(x)(\partial_i + ieA_i(x))\psi(x) + m^2\psi^*(x)\psi(x) \\ &= \eta^*(x)\eta(x) + \partial_i\psi^*(x)\partial_i\psi(x) \\ &\quad + ieA_0(x)(\psi^*(x)\eta(x) - \eta^*(x)\psi(x)) - ieA_i(x)(\psi^*(x)\partial_i\psi(x) - \partial_i\psi^*(x)\psi(x)) \\ &\quad + e^2\vec{A}(x)^2\psi^*(x)\psi(x) + m^2\psi^*(x)\psi(x).\end{aligned}$$

The Hamiltonian

$$H(t) = \int \mathcal{H}(t, \vec{x}) d\vec{x}$$

can be used to generate the dynamics

$$\dot{\psi}(t, \vec{x}) = \{\psi(t, \vec{x}), H(t)\}, \quad \dot{\eta}(t, \vec{x}) = \{\eta(t, \vec{x}), H(t)\}.$$

The interaction picture Hamiltonian can be partially expressed in terms of the free 4-current density:

$$\begin{aligned}H_{\text{Int}}(t) &= \int d\vec{x} \left(eA_\mu(t, \vec{x}) \mathcal{J}_{\text{fr}}^\mu(t, \vec{x}) + e^2 \vec{A}(t, \vec{x})^2 \psi_{\text{fr}}^*(t, \vec{x}) \psi_{\text{fr}}(t, \vec{x}) \right) \\ &= \int d\vec{x} \left(eA_0(t, \vec{x}) \mathcal{Q}_{\text{fr}}(t, \vec{x}) \right. \\ &\quad \left. + e\vec{A}(t, \vec{x}) \vec{\mathcal{J}}_{\text{fr}}(t, \vec{x}) + e^2 \vec{A}(t, \vec{x})^2 \psi_{\text{fr}}^*(t, \vec{x}) \psi_{\text{fr}}(t, \vec{x}) \right)\end{aligned}\tag{5.39}$$

$$\begin{aligned}
&= \frac{e}{2} \int \int \frac{d\vec{p}_1 d\vec{p}_2}{(2\pi)^3} \left(\sqrt{\frac{E(\vec{p}_1)}{E(\vec{p}_2)}} + \sqrt{\frac{E(\vec{p}_2)}{E(\vec{p}_1)}} \right) \\
&\quad \times \left(A_0(t, \vec{p}_1 - \vec{p}_2) e^{itE(\vec{p}_1) - itE(\vec{p}_2)} a^*(p_1) a(p_2) - A_0(t, -\vec{p}_1 + \vec{p}_2) e^{-itE(\vec{p}_1) + itE(\vec{p}_2)} b(p_1) b^*(p_2) \right) \\
&+ \frac{e}{2} \int \int \frac{d\vec{p}_1 d\vec{p}_2}{(2\pi)^3} \left(\sqrt{\frac{E(\vec{p}_1)}{E(\vec{p}_2)}} - \sqrt{\frac{E(\vec{p}_2)}{E(\vec{p}_1)}} \right) \\
&\quad \times \left(A_0(t, \vec{p}_1 + \vec{p}_2) e^{itE(\vec{p}_1) + itE(\vec{p}_2)} a^*(p_1) b^*(p_2) - A_0(t, -\vec{p}_1 - \vec{p}_2) e^{-itE(\vec{p}_1) - itE(\vec{p}_2)} b(p_1) a(p_2) \right) \\
&+ \frac{e}{2} \int \int \frac{d\vec{p}_1 d\vec{p}_2}{(2\pi)^3 \sqrt{E(\vec{p}_1) E(\vec{p}_2)}} (\vec{p}_1 + \vec{p}_2) \\
&\quad \times \left(-\vec{A}(t, \vec{p}_1 - \vec{p}_2) e^{itE(\vec{p}_1) - itE(\vec{p}_2)} a^*(p_1) a(p_2) + \vec{A}(t, -\vec{p}_1 + \vec{p}_2) e^{-itE(\vec{p}_1) + itE(\vec{p}_2)} b(p_1) b^*(p_2) \right) \\
&+ \frac{e}{2} \int \int \frac{d\vec{p}_1 d\vec{p}_2}{(2\pi)^3 \sqrt{E(\vec{p}_1) E(\vec{p}_2)}} (\vec{p}_1 - \vec{p}_2) \\
&\quad \times \left(-\vec{A}(t, \vec{p}_1 + \vec{p}_2) e^{itE(\vec{p}_1) + itE(\vec{p}_2)} a^*(p_1) b^*(p_2) + \vec{A}(t, -\vec{p}_1 - \vec{p}_2) e^{-itE(\vec{p}_1) - itE(\vec{p}_2)} b(p_1) a(p_2) \right) \\
&+ \frac{e^2}{2} \int \int \frac{d\vec{p}_1 d\vec{p}_2}{(2\pi)^3 \sqrt{E(\vec{p}_1)} \sqrt{E(\vec{p}_2)}} \\
&\quad \times \left(\vec{A}^2(\vec{p}_1 - \vec{p}_2) e^{itE(\vec{p}_1) - itE(\vec{p}_2)} a^*(p_1) a(p_2) + \vec{A}^2(-\vec{p}_1 + \vec{p}_2) e^{-itE(\vec{p}_1) + itE(\vec{p}_2)} b(p_1) b^*(p_2) \right) \\
&\quad + \vec{A}^2(\vec{p}_1 + \vec{p}_2) e^{itE(\vec{p}_1) + itE(\vec{p}_2)} a^*(p_1) b^*(p_2) + \vec{A}^2(-\vec{p}_1 - \vec{p}_2) e^{-itE(\vec{p}_1) - itE(\vec{p}_2)} b(p_1) a(p_2) \Big).
\end{aligned}$$

5.2.3 Classical discrete symmetries

Choose $\xi_C \in \mathbb{C}$, $|\xi_C| = 1$. If ζ solves the Klein-Gordon equation with the 4-potential A , then so does $\xi_C \bar{\zeta}$ with the 4-potential $-A$. Thus replacing

$$\begin{aligned}
&\psi(x), \psi^*(x), A(x) \\
\text{with } &\bar{\xi}_C \psi^*(x), \xi_C \psi(x), -A(x)
\end{aligned}$$

is a symmetry of the complex Klein-Gordon equation with an external 4-potential (5.35). It is called *charge conjugation* and denoted \mathcal{C} .

Choose $\xi_P \in \{1, -1\}$. Recall that $P(x^0, \vec{x}) := (x^0, -\vec{x})$ denotes the space inversion. Replacing

$$\begin{aligned}
&\psi(x), \psi^*(x), (A_0(x), \vec{A}(x)) \\
\text{with } &\xi_P \psi(Px), \xi_P \psi^*(Px), (A_0(Px), -\vec{A}(Px))
\end{aligned}$$

is a symmetry of (5.35) called *parity* and denoted \mathcal{P} .

Choose $\xi_T \in \mathbb{C}$, $|\xi_T| = 1$. Recall that $T(x^0, \vec{x}) := (-x^0, \vec{x})$ denotes the time reflection. Replacing

$$\begin{aligned}
&\psi(x), \psi^*(x), (A_0(x), \vec{A}(x)) \\
\text{with } &\bar{\xi}_T \psi^*(Tx), \xi_T \psi(Tx), (A_0(Tx), -\vec{A}(Tx))
\end{aligned}$$

is a symmetry of (5.35) called *time reversal* and denoted \mathcal{T} .

The composition of \mathcal{C} , \mathcal{P} and \mathcal{T} has an especially simple form if $\bar{\xi}_C \xi_P \xi_T = 1$. It consists in replacing

$$\begin{aligned} & \psi(x), \psi^*(x), A(x) \\ \text{with} & \quad \psi(-x), \psi^*(-x), -A(-x). \end{aligned}$$

It is called the *CPT symmetry* and is denoted \mathcal{X} .

\mathcal{C} , \mathcal{P} , \mathcal{T} and \mathcal{X} commute with one another and we have the relations

$$\mathcal{C}^2 = \mathcal{P}^2 = \mathcal{T}^2 = \mathcal{X} = \text{id}.$$

5.2.4 Quantization

We are looking for a quantum field satisfying

$$(-(\partial_\mu + ieA_\mu(x))(\partial^\mu + ieA^\mu(x)) + m^2) \hat{\psi}(x) = 0. \quad (5.40)$$

We set

$$\hat{\eta}(x) := \partial_0 \hat{\psi}(x) + ieA_0(x) \hat{\psi}(x).$$

We will assume that $\hat{\psi}$, $\hat{\eta}$ act on the Hilbert space of free fields

$$\Gamma_s(\mathcal{Z}_{\text{KG}}^{(+)} \oplus \mathcal{Z}_{\text{KG}}^{(-)}),$$

and at time $t = 0$ we have

$$\begin{aligned} \hat{\psi}(\vec{x}) &:= \hat{\psi}(0, \vec{x}) = \hat{\psi}_{\text{fr}}(0, \vec{x}), \\ \hat{\eta}(\vec{x}) &:= \hat{\eta}(0, \vec{x}) = \hat{\eta}_{\text{fr}}(0, \vec{x}). \end{aligned}$$

The solution is unique and is obtained by decorating (5.38) with “hats”.

We would like to ask whether the quantum fields are implemented by a unitary dynamics. Equivalently, we want to check if the classical dynamics generated by $H_{\text{Int}}(t)$ satisfies the Shale criterion (Thm A.2).

By following the discussion of Subsubsection. 2.3.4 we check that the classical scattering operator is unitarily implementable.

The Shale criterion is satisfied for the dynamics from t_- to t_+ iff the spatial part of the 4-potential is the same at the initial and final time:

$$\vec{A}(t_+, \vec{x}) = \vec{A}(t_-, \vec{x}), \quad \vec{x} \in \mathbb{R}^3. \quad (5.41)$$

To see this note that $H_{\text{Int}}(t)$ consists of three terms described in (5.39).

The term $e^2 \vec{A}(t, \vec{x})^2 \psi_{\text{fr}}^*(t, \vec{x}) \psi_{\text{fr}}(t, \vec{x})$ is very similar to the mass-like perturbation considered already in Subsubsection. 2.3.4, which did not cause problems with the Shale criterion for the dynamics for any t_+ , t_- .

The same is true for the term $eA_0(t, \vec{x}) \mathcal{Q}_{\text{fr}}(t, \vec{x})$. Indeed, a similar term was discussed before in the context of gauge transformations, see in particular (5.31). Then there was a problem with the square integrability. But now we can integrate by parts, which improves the decay.

The term $e\vec{A}(t, \vec{x}) \vec{\mathcal{J}}_{\text{fr}}(t, \vec{x})$ is problematic – it has worse behavior for large momenta than the previous two terms. The integration by parts creates a boundary term that is not square integrable unless (5.41) holds, when it vanishes.

5.2.5 Quantum Hamiltonian

Formally, the fields undergo a unitary dynamics given by

$$\hat{\psi}(t, \vec{x}) := \text{Texp} \left(-i \int_t^0 \hat{H}(s) ds \right) \hat{\psi}(0, \vec{x}) \text{Texp} \left(-i \int_0^t \hat{H}(s) ds \right),$$

where the Schrödinger picture Hamiltonian is

$$\begin{aligned} \hat{H}(t) = & \int d\vec{x} \left(\hat{\eta}^*(\vec{x}) \hat{\eta}(\vec{x}) + ieA_0(t, \vec{x}) : (\hat{\psi}^*(\vec{x}) \hat{\eta}(\vec{x}) - \hat{\eta}^*(\vec{x}) \hat{\psi}(\vec{x})) : \right. \\ & + (\partial_i - ieA_i(t, \vec{x})) \hat{\psi}^*(\vec{x}) (\partial_i + ieA_i(t, \vec{x})) \hat{\psi}(\vec{x}) \\ & \left. + m^2 \hat{\psi}^*(\vec{x}) \hat{\psi}(\vec{x}) \right). \end{aligned} \quad (5.42)$$

Note that the above Hamiltonian is formally the Weyl quantization of its corresponding classical expressions. This is perhaps not obvious the way it is written. To see this we should note that equal time $\hat{\psi}$ and $\hat{\psi}^*$ commute, the same is true for equal time $\hat{\eta}$ and $\hat{\eta}^*$, finally the mixed term can be expressed by the 4-current where the Wick and Weyl quantizations coincide, see Subsubsection. 5.1.10.

In any case, the analysis of the previous subsection shows that the above Hamiltonian is often ill defined and should be understood as a formal expression, even when we try renormalize by adding a constant $C(t)$. We will need it to develop perturbation expansion for the quantum scattering operator and to compute the energy shift.

(5.42) can be compared with the free Hamiltonian without the Wick ordering, which differs from (5.25) by an (infinite) constant:

$$\hat{H}_{\text{fr}} = \int d\vec{x} \left(\hat{\eta}^*(\vec{x}) \hat{\eta}(\vec{x}) + \partial_i \hat{\psi}^*(\vec{x}) \partial_i \hat{\psi}(\vec{x}) + m^2 \hat{\psi}^*(\vec{x}) \hat{\psi}(\vec{x}) \right). \quad (5.43)$$

This leads to the following interaction picture Hamiltonian:

$$\begin{aligned} \hat{H}_{\text{Int}}(t) &= \int d\vec{x} \left(eA_\mu(t, \vec{x}) \hat{\mathcal{J}}_{\text{fr}}^\mu(t, \vec{x}) + e^2 \vec{A}(t, \vec{x})^2 \hat{\psi}_{\text{fr}}^*(t, \vec{x}) \hat{\psi}_{\text{fr}}(t, \vec{x}) \right) \\ &= \int d\vec{x} \left(eA_\mu(t, \vec{x}) \hat{\mathcal{J}}_{\text{fr}}^\mu(t, \vec{x}) + e^2 A(t, \vec{x})^2 \hat{\psi}_{\text{fr}}^*(t, \vec{x}) \hat{\psi}_{\text{fr}}(t, \vec{x}) \right. \\ &\quad \left. + e^2 A_0(t, \vec{x})^2 \hat{\psi}_{\text{fr}}^*(t, \vec{x}) \hat{\psi}_{\text{fr}}(t, \vec{x}) \right). \end{aligned} \quad (5.44)$$

5.2.6 Quantized discrete symmetries

The discrete symmetries considered in Subsubsection. 5.2.3 remain true when we decorate the fields with “hats”. Thus on the level of quantum observables the discrete symmetries are the same as in the classical case.

A separate discussion is needed concerning the implementation of these symmetries by unitary or antiunitary operators on the Hilbert space $\Gamma_s(\mathcal{Z}_{\text{KG}}^{(+)} \oplus \mathcal{Z}_{\text{KG}}^{(-)})$. We will discuss this for free fields, that is, for $A = 0$. Free fields are used to compute the scattering operator for the 4-potential A , denoted by $\hat{S}(A)$. Therefore, our analysis will lead to some identities for $\hat{S}(A)$.

First consider the charge conjugation. As we have already pointed out in Subsubsection. 5.1.8, the spaces $\mathcal{Z}_{\text{KG}}^{(+)}$ and $\mathcal{Z}_{\text{KG}}^{(-)}$ can be naturally identified. Therefore, we can define a unitary operator on $\mathcal{Z}_{\text{KG}}^{(+)} \oplus \mathcal{Z}_{\text{KG}}^{(-)}$

$$\chi(g_1, \bar{g}_2) := (\xi_C \bar{g}_2, \bar{\xi}_C g_1).$$

Clearly,

$$\chi|p) = \xi_C \overline{|-p)}, \quad \overline{\chi|-p)} = \bar{\xi}_C |p).$$

We set $C := \Gamma(\chi)$. We have $C^2 = \mathbb{1}$, $C\Omega = \Omega$,

$$\begin{aligned} C\hat{\psi}_{\text{fr}}(x)C^{-1} &= \xi_C \hat{\psi}_{\text{fr}}^*(x), & C\hat{\psi}_{\text{fr}}^*(x)C^{-1} &= \bar{\xi}_C \hat{\psi}_{\text{fr}}(x), \\ C\hat{\mathcal{Q}}_{\text{fr}}(x)C^{-1} &= -\hat{\mathcal{Q}}_{\text{fr}}(x), & C\vec{\mathcal{J}}_{\text{fr}}(x)C^{-1} &= -\vec{\mathcal{J}}_{\text{fr}}(x), \\ C\hat{S}(A)C^{-1} &= \hat{S}(-A). \end{aligned}$$

Define a unitary operator on $\mathcal{Z}_{\text{KG}}^{(+)} \oplus \mathcal{Z}_{\text{KG}}^{(-)}$

$$\pi(g_1, \bar{g}_2) := (\xi_P g_1 \circ \text{P}, \xi_P \overline{\bar{g}_2 \circ \text{P}}).$$

(The circle denotes the composition of two functions). Clearly,

$$\pi|E, \vec{p}) = \xi_P |E, -\vec{p}), \quad \pi|-E, -\vec{p}) = \xi_P |-E, \vec{p}).$$

We have a natural implementation of the parity $P := \Gamma(\pi)$. It satisfies $P^2 = \mathbb{1}$, $P\Omega = \Omega$,

$$\begin{aligned} P\hat{\psi}_{\text{fr}}(x)P^{-1} &= \xi_P \hat{\psi}_{\text{fr}}(\text{P}x), & P\hat{\psi}_{\text{fr}}^*(x)P^{-1} &= \xi_P \hat{\psi}_{\text{fr}}^*(\text{P}x), \\ P\hat{\mathcal{Q}}_{\text{fr}}(x)P^{-1} &= \hat{\mathcal{Q}}_{\text{fr}}(\text{P}x), & P\vec{\mathcal{J}}_{\text{fr}}(x)P^{-1} &= -\vec{\mathcal{J}}_{\text{fr}}(\text{P}x), \\ P\hat{S}(A^0, \vec{A})P^{-1} &= \hat{S}(A^0 \circ \text{P}, -\vec{A} \circ \text{P}). \end{aligned}$$

Define the following antiunitary operator on $\mathcal{Z}_{\text{KG}}^{(+)} \oplus \mathcal{Z}_{\text{KG}}^{(-)}$:

$$\tau(g_1, \bar{g}_2) := (\xi_T \overline{\bar{g}_1 \circ \text{T}}, \bar{\xi}_T g_2 \circ \text{T}).$$

Clearly,

$$\tau|E, \vec{p}) = \xi_T |E, -\vec{p}), \quad \tau|-E, -\vec{p}) = \bar{\xi}_T |-E, \vec{p}).$$

Set $T := \Gamma(\tau)$. We have $T^2 = \mathbb{1}$, $T\Omega = \Omega$,

$$\begin{aligned} T\hat{\psi}_{\text{fr}}(x)T^{-1} &= \bar{\xi}_T \hat{\psi}_{\text{fr}}^*(\text{T}x), & T\hat{\psi}_{\text{fr}}^*(x)T^{-1} &= \xi_T \hat{\psi}_{\text{fr}}(\text{T}x), \\ T\hat{\mathcal{Q}}_{\text{fr}}(x)T^{-1} &= \hat{\mathcal{Q}}_{\text{fr}}(\text{T}x), & T\vec{\mathcal{J}}_{\text{fr}}(x)T^{-1} &= -\vec{\mathcal{J}}_{\text{fr}}(\text{T}x), \\ T\hat{S}(A^0, \vec{A})T^{-1} &= \overline{\hat{S}(A^0 \circ \text{T}, -\vec{A} \circ \text{T})}. \end{aligned}$$

5.2.7 $2N$ -point Green's functions

For $y_N, \dots, y_1, x_N, \dots, x_1$, the $2N$ point Green's function are defined as follows:

$$\begin{aligned} & \langle \hat{\psi}^*(y_1) \cdots \hat{\psi}^*(y_N) \hat{\psi}(x_N) \cdots \hat{\psi}(x_1) \rangle \\ & := \left(\Omega^+ | \text{T} \left(\hat{\psi}^*(y_1) \cdots \hat{\psi}^*(y_N) \hat{\psi}(x_N) \cdots \hat{\psi}(x_1) \right) \Omega^- \right). \end{aligned}$$

One can organize Green's functions in terms of the *generating function*:

$$\begin{aligned} & Z(g, \bar{g}) \\ & := \sum_{n=0}^{\infty} \int \cdots \int \frac{(-1)^N}{(N!)^2} \langle \hat{\psi}^*(y_1) \cdots \hat{\psi}^*(y_N) \hat{\psi}(x_N) \cdots \hat{\psi}(x_1) \rangle \\ & \quad \times g(y_1) \cdots g(y_N) \overline{g(x_N)} \cdots \overline{g(x_1)} dy_1 \cdots dy_N dx_N \cdots dx_1 \\ & = \left(\Omega | \text{Texp} \left(-i \int_{-\infty}^{\infty} \hat{H}_{\text{Int}}(t) dt - i \int g(x) \hat{\psi}_{\text{fr}}^*(x) dx - i \int \overline{g(x)} \hat{\psi}_{\text{fr}}(x) dx \right) \Omega \right). \end{aligned}$$

One can retrieve Green's functions from the generating function:

$$\begin{aligned} & \langle \hat{\psi}^*(y_1) \cdots \hat{\psi}^*(y_N) \hat{\psi}(x_N) \cdots \hat{\psi}(x_1) \rangle \\ & = (-1)^N \frac{\partial^{2N}}{\partial g(y_1) \cdots \partial g(y_N) \partial \overline{g(x_N)} \cdots \partial \overline{g(x_1)}} Z(g, \bar{g}) \Big|_{g=\bar{g}=0}. \end{aligned}$$

We introduce also the *amputated Green's function*

$$\begin{aligned} & \langle \hat{\psi}^*(p'_1) \cdots \hat{\psi}^*(p'_N) \hat{\psi}(p_N) \cdots \hat{\psi}(p_1) \rangle_{\text{amp}} \\ & := ((p'_1)^2 + m^2) \cdots ((p'_N)^2 + m^2) ((p_N)^2 + m^2) \cdots ((p_1)^2 + m^2) \\ & \quad \times \langle \hat{\psi}^*(p'_1) \cdots \hat{\psi}^*(p'_N) \hat{\psi}(p_N) \cdots \hat{\psi}(p_1) \rangle. \end{aligned}$$

Set

$$|\overline{-p'_{n'}}, \dots, \overline{-p'_1}, p_n, \dots, p_1\rangle := \hat{b}^*(p'_{n'}) \cdots \hat{b}^*(p'_1) \hat{a}^*(p_n) \cdots \hat{a}^*(p_1) \Omega.$$

One can compute *scattering amplitudes* from the amputated Green's functions:

$$\begin{aligned} & \left(\overline{-p_{n^+}^{\prime}}, \dots, p_{n^+}^+, \dots | \hat{S} | \overline{-p_{n^-}^{\prime}}, \dots, p_{n^-}^-, \dots \right) \\ & = \frac{\langle \cdots \hat{\psi}(p_{n^+}^+) \cdots \hat{\psi}^*(p_{n^+}^{\prime}) \hat{\psi}(-p_{n^-}^{\prime}) \cdots \hat{\psi}^*(-p_{n^-}^-) \cdots \rangle_{\text{amp}}}{\sqrt{(2\pi)^{3(n^++n^{\prime}+n^-+n^-)}} \cdots \sqrt{2E(p_{n^+}^+)}} \cdots \sqrt{2E(p_{n^+}^{\prime})} \sqrt{2E(p_{n^-}^{\prime})} \cdots \sqrt{2E(p_{n^-}^-)} \cdots, \end{aligned}$$

where all $p_i^{\pm}, p_i^{\pm'}$ are on shell.

5.2.8 Path integral formulation

Since the Hamiltonian that we consider is quadratic, we can compute exactly the generating function in terms of the Fredholm determinant on $L^2(\mathbb{R}^{1,3})$:

$$\begin{aligned}
& Z(g, \bar{g}) \tag{5.45} \\
&= \det(-\square + m^2) (-\partial_\mu + ieA_\mu(x))(\partial^\mu + ieA^\mu(x) + m^2 - i0)^{-1} \\
&\quad \times \exp\left(i\bar{g}((\partial_\mu + ieA_\mu(x))(\partial^\mu + ieA^\mu(x) + m^2 - i0)^{-1}g)\right) \\
&= \det\left(\mathbb{1} + \left(-ieA_\mu(x)\partial^\mu - ie\partial^\mu A_\mu(x) + e^2 A_\mu(x)A^\mu(x)\right)D_{\text{fr}}^c\right)^{-1} \\
&\quad \times \exp\left(i\bar{g}D_{\text{fr}}^c\left(\mathbb{1} + \left(-ieA_\mu(x)\partial^\mu - ie\partial^\mu A_\mu(x) + e^2 A_\mu(x)A^\mu(x)\right)D_{\text{fr}}^c\right)^{-1}g\right).
\end{aligned}$$

Let us stress that the above formulas are based on the formal expression for the Hamiltonian (5.44) where we used the Weyl quantization, in contrast to the analogous formula (2.112) for the mass-like perturbation, which were Wick ordered. The expression is to a large degree ill-defined.

Formally, (5.45) can be rewritten in terms of path integrals as

$$\frac{\int \prod_y d\psi^*(x) \prod_{y'} d\psi(y) \exp\left(i \int (\mathcal{L}(x) - g(x)\psi^*(x) - \overline{g(x)}\psi(x)) dx\right)}{\int \prod_y d\psi^*(y) \prod_{y'} d\psi(y') \exp\left(i \int \mathcal{L}_{\text{fr}}(x) dx\right)}.$$

5.2.9 Feynman rules

Let us describe the Feynman rules for the charged scalar field in an external 4-potential. We have 1 kind of lines and 2 kinds of vertices. Each line has an arrow. At each vertex two lines meet, one with an arrow pointing towards, one with an arrow pointing away from the vertex. The 1-photon vertex is denoted by an attached “photon line” ending with a small cross. The 2-photon vertex has two “photon lines”, each ending with a cross. Note that the “photon lines” are in this context only decorations of the vertices – there are no photons in this theory. They are usually denoted by wavy, sometimes dashed lines. For typographical reasons we use dashed lines.

To compute Green’s functions we do as follows:

- (1) We draw all possible Feynman diagrams.
- (2) (i) To each 1-photon vertex we associate the factor

$$ie(p_\nu^+ + p_\nu^-)A^\nu(p^+ - p^-).$$

- (ii) To each 2-photon vertex we associate the factor

$$-ie^2(A^\nu A_\nu)(p^+ - p^-).$$

(3) To each line we associate the propagator

$$-iD_{\text{fr}}^c(p) = \frac{-i}{p^2 + m^2 - i0}.$$

(4) We integrate over the variables of internal lines with the measure $\frac{d^4p}{(2\pi)^4}$.

It is immediate to derive the Feynman rules for charged scalar bosons from the path integral formula (5.45).

The derivation of the Feynman rules within the Hamiltonian formalism using the Dyson expansion of the scattering operator is relatively complicated, since one has to use not only the two-point functions of “configuration space fields” ψ, ψ^* , but also of conjugate fields η, η^* [26]:

$$\begin{aligned} (\Omega|\text{T}(\hat{\psi}_{\text{fr}}(x)\hat{\psi}_{\text{fr}}^*(y))\Omega) &= -iD_{\text{fr}}^c(x-y), \\ (\Omega|\text{T}(\hat{\eta}_{\text{fr}}(x)\hat{\psi}_{\text{fr}}^*(y))\Omega) &= -i\partial_{x^0}D_{\text{fr}}^c(x-y), \\ (\Omega|\text{T}(\hat{\psi}_{\text{fr}}(x)\hat{\eta}_{\text{fr}}^*(y))\Omega) &= -i\partial_{y^0}D_{\text{fr}}^c(x-y), \\ (\Omega|\text{T}(\hat{\eta}_{\text{fr}}(x)\hat{\eta}_{\text{fr}}^*(y))\Omega) &= -i\partial_{x^0}\partial_{y^0}D_{\text{fr}}^c(x-y) - i\delta(x-y). \end{aligned}$$

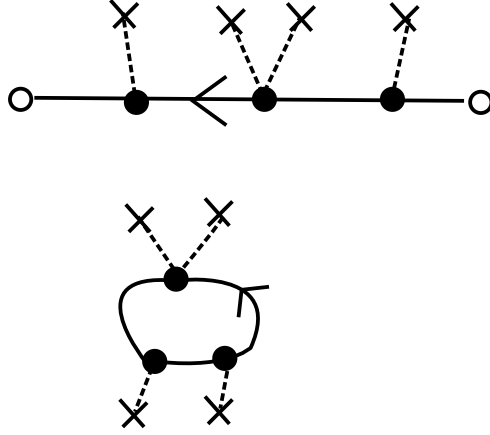

Figure 7: Diagram for Green's function.

To compute scattering amplitudes with N^- incoming and N^+ outgoing particles we draw similar diagrams as for $N^- + N^+$ -point Green's functions, where as usual the incoming lines are drawn on the right and outgoing lines on the left. The rules are changed only concerning the external lines.

(i) With each incoming external line we associate

- charged boson: $\frac{1}{\sqrt{(2\pi)^3 2E(\vec{p})}}$.

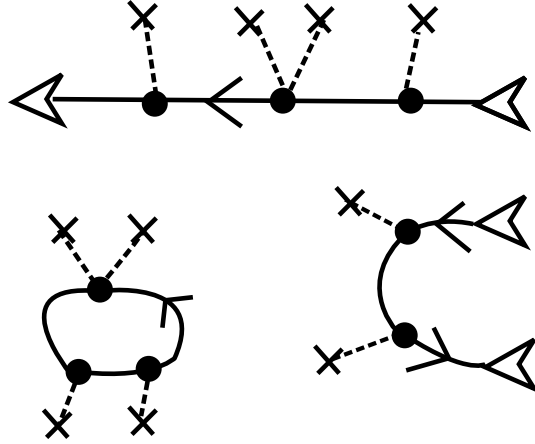

Figure 8: Diagram for scattering amplitudes.

- charged anti-boson: $\frac{1}{\sqrt{(2\pi)^3 2E(\vec{p})}}$.

(ii) With each outgoing external line we associate

- charged boson: $\frac{1}{\sqrt{(2\pi)^3 2E(\vec{p})}}$.
- charged anti-boson: $\frac{1}{\sqrt{(2\pi)^3 2E(\vec{p})}}$.

5.2.10 Vacuum energy

Formally, the vacuum energy can be computed exactly:

$$\begin{aligned}
\mathcal{E} &:= i \log(\Omega | \hat{S} \Omega) = i \log Z(0, 0) \\
&= i \text{Tr} \left(\log(-\square + m^2 - i0) - \log(-(\partial_\mu + ieA_\mu(x))(\partial^\mu + ieA^\mu(x)) + m^2 - i0) \right) \\
&= -i \text{Tr} \left(\log \left(\mathbb{1} + (-ieA_\mu(x)\partial^\mu - ie\partial^\mu A_\mu(x) + e^2 A_\mu(x)A^\mu(x)) D_{\text{fr}}^c \right) \right) \\
&= i \sum_\ell \frac{D_\ell}{n_\ell}. \tag{5.46}
\end{aligned}$$

Here D_ℓ is the value of the loop ℓ and n_ℓ is its *symmetry factor*. Any such a loop is described by a cyclic sequence $(\alpha_1, \dots, \alpha_n)$, where $\alpha_j = 1, 2$ correspond to 1- and 2-photon vertices. The symmetry factor n_ℓ is the order of the group of the automorphisms of this loop. The loop is oriented, hence this group is always a subgroup of rotations. In particular, if the loop has n identical vertices, the group is \mathbb{Z}_n and $n_\ell = n$.

Actually, it is better to organize (5.46) not in terms of the number of vertices on a loop but in terms of the order wrt e . Using the unitary charge conjugation

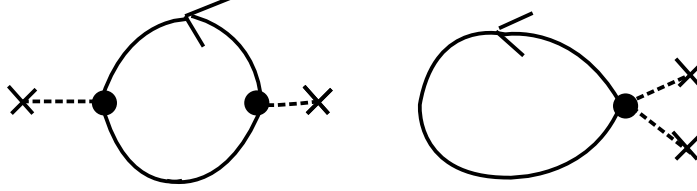

Figure 9: Divergent diagrams for vacuum energy.

operator C and $C\Omega = \Omega$ we obtain

$$(\Omega|\hat{S}(A)\Omega) = (\Omega|C\hat{S}(A)C^{-1}\Omega) = (\Omega|\hat{S}(-A)\Omega).$$

Therefore, diagrams of an odd order in e vanish. This is the content of *Furry's theorem* for charged bosons. Hence (5.46) can be written as

$$\mathcal{E} = \sum_{n=1}^{\infty} e^{2n} \mathcal{E}_n.$$

The expressions for \mathcal{E}_n obtained from the Feynman rules are convergent for $n \geq 3$. \mathcal{E}_2 is logarithmically divergent, but its physically relevant gauge invariant part is convergent. \mathcal{E}_1 is quadratically divergent and its gauge-invariant part is logarithmically divergent. It needs an infinite renormalization, which will be described below.

5.2.11 Pauli-Villars renormalization

The lowest nonzero loop diagrams are of the second order in e , and hence of the first order in $\alpha = \frac{e^2}{4\pi}$. There are two kinds of loops of this order: a loop with two 1-photon vertices with symmetry factor 2 and a loop with a 2-photon vertex with symmetry factor 1, see the Fig. 9. The sum of their contributions has the form

$$\mathcal{E}_1 = \int \frac{dp}{(2\pi)^4} A^\mu(-p) A^\nu(p) \Pi_{\mu\nu}(p). \quad (5.47)$$

(5.47) defines the *vacuum energy tensor* $\Pi_{\mu\nu}(p)$.

We will first compute $\Pi_{\mu\nu}$ using the *Pauli-Villars regularization*. The ultraviolet problem is more severe now than it was for the mass-like perturbation, where a single additional fictitious particle sufficed to make the expressions well defined. Now we need two fictitious particles:

$$\begin{aligned} m_0^2 &:= m^2, & C_0 &:= 1, \\ m_1^2 &:= m^2 + 2\Lambda^2, & C_1 &:= 1, \\ m_2^2 &:= m^2 + \Lambda^2, & C_2 &:= -2. \end{aligned}$$

Using

$$\sum_{i=0}^2 C_i = \sum_{i=0}^2 C_i m_i^2 = 0 \quad (5.48)$$

we can check that with this choice the sums used in the following computations are integrable.

In the following formula we have a contribution of the loop with 2 single-photon vertices and twice the contribution of the loop with a single 2-photon vertex. It is convenient to write the latter as the sum of two terms, equal to one another.

$$\begin{aligned} 2\Pi_{\mu\nu\Lambda}(p) &= ie^2 \int \frac{d^4q}{(2\pi)^4} \sum_i C_i \left(\frac{4q_\mu q_\nu}{((q + \frac{1}{2}p)^2 + m_i^2 - i0)((q - \frac{1}{2}p)^2 + m_i^2 - i0)} \right. \\ &\quad \left. - \frac{g_{\mu\nu}}{((q + \frac{1}{2}p)^2 + m_i^2 - i0)} - \frac{g_{\mu\nu}}{((q - \frac{1}{2}p)^2 + m_i^2 - i0)} \right) \\ &= ie^2 \int \frac{d^4q}{(2\pi)^4} \sum_i C_i \frac{4q_\mu q_\nu - 2g_{\mu\nu}(q^2 + \frac{1}{4}p^2 + m_i^2)}{((q + \frac{1}{2}p)^2 + m_i^2 - i0)((q - \frac{1}{2}p)^2 + m_i^2 - i0)} \\ &= -\frac{e^2}{(4\pi)^2} \int_0^\infty d\alpha_1 \int_0^\infty d\alpha_2 \sum_i C_i \left(\frac{(\alpha_1 - \alpha_2)^2}{(\alpha_1 + \alpha_2)^4} (g_{\mu\nu} p^2 - p_\mu p_\nu) \right. \\ &\quad \left. + 2g_{\mu\nu} \left(\frac{\alpha_1 \alpha_2}{(\alpha_1 + \alpha_2)^4} p^2 - \frac{i}{(\alpha_1 + \alpha_2)^3} + \frac{m_i^2}{(\alpha_1 + \alpha_2)^2} \right) \right) \\ &\quad \times \exp \left(-i(\alpha_1 + \alpha_2)m_i^2 - i\frac{\alpha_1 \alpha_2}{\alpha_1 + \alpha_2} p^2 \right) \\ &=: (-g_{\mu\nu} p^2 + p_\mu p_\nu) 2\Pi_\Lambda^{\text{gi}}(p^2) + 2\Pi_{\mu\nu\Lambda}^{\text{gd}}(p^2). \end{aligned}$$

We used the identity (A.23).

The gauge dependent part of the vacuum energy tensor vanishes:

$$\begin{aligned}
& -\Pi_{\mu\nu\Lambda}^{\text{gd}}(p^2) \\
= & \sum_i C_i \frac{e^2}{(4\pi)^2} \int_0^\infty d\alpha_1 \int_0^\infty d\alpha_2 \exp\left(-i(\alpha_1 + \alpha_2)m_i^2 - i\frac{\alpha_1\alpha_2}{\alpha_1 + \alpha_2}p^2\right) \\
& \times g_{\mu\nu} \left(\frac{\alpha_1\alpha_2 p^2}{(\alpha_1 + \alpha_2)^4} - \frac{i}{(\alpha_1 + \alpha_2)^3} + \frac{m_i^2}{(\alpha_1 + \alpha_2)^2} \right) \\
= & \sum_i C_i \frac{e^2}{(4\pi)^2} \rho \partial_\rho \int_0^\infty d\alpha_1 \int_0^\infty d\alpha_2 \exp\left(-i\rho \left((\alpha_1 + \alpha_2)m_i^2 + \frac{\alpha_1\alpha_2}{\alpha_1 + \alpha_2}p^2 \right)\right) \\
& \times \frac{ig_{\mu\nu}}{\rho(\alpha_1 + \alpha_2)^3} \Big|_{\rho=1} \\
= & \sum_i C_i \frac{e^2}{(4\pi)^2} \rho \partial_\rho \int_0^\infty d\alpha_1 \int_0^\infty d\alpha_2 \exp\left(-i \left((\alpha_1 + \alpha_2)m_i^2 + \frac{\alpha_1\alpha_2}{\alpha_1 + \alpha_2}p^2 \right)\right) \\
& \times \frac{ig_{\mu\nu}}{(\alpha_1 + \alpha_2)^3} = 0.
\end{aligned}$$

To compute the gauge invariant part we proceed similarly as in Subsubsec. 2.3.9, see (2.113), and we obtain

$$\begin{aligned}
\Pi_\Lambda^{\text{gi}}(p^2) &= -\frac{e^2}{2(4\pi)^2} \int_0^\infty d\alpha_1 \int_0^\infty d\alpha_2 \sum_i C_i \frac{(\alpha_1 - \alpha_2)^2}{(\alpha_1 + \alpha_2)^4} \\
& \times \exp\left(-i(\alpha_1 + \alpha_2)m_i^2 - i\frac{\alpha_1\alpha_2}{\alpha_1 + \alpha_2}p^2\right) \\
&= -\frac{e^2}{2(4\pi)^2} \int_0^1 dv \int_0^\infty \frac{d\rho}{\rho} \sum_i C_i v^2 \exp\left(-i\rho \left(m_i^2 + \frac{(1-v^2)p^2}{4} \right)\right) \\
&= \frac{e^2}{2(4\pi)^2} \int_0^1 dv \sum_i C_i v^2 \log\left(m_i^2 + \frac{(1-v^2)p^2}{4} - i0\right).
\end{aligned}$$

We define

$$\begin{aligned}
\Pi^{\text{ren}}(p^2) &:= \lim_{\Lambda \rightarrow \infty} (\Pi_\Lambda^{\text{gi}}(p^2) - \Pi_\Lambda^{\text{gi}}(0)) \\
&= \frac{e^2}{2(4\pi)^2} \int_0^1 dv v^2 \log\left(1 + \frac{(1-v^2)p^2}{4m^2} - i0\right).
\end{aligned} \tag{5.49}$$

Using (A.27), and then analytic continuation, we obtain

$$\begin{aligned}
& \Pi^{\text{ren}}(p^2) \\
&= \frac{e^2}{2 \cdot 3(4\pi)^2} \left(\frac{(p^2 + 4m^2)^{3/2}}{(p^2)^{3/2}} \log \frac{\sqrt{p^2 + 4m^2} + \sqrt{p^2}}{\sqrt{p^2 + 4m^2} - \sqrt{p^2}} \right. \\
&\quad \left. - \frac{2}{3} - 2 \left(\frac{4m^2}{p^2} + 1 \right) \right), \quad 0 < p^2; \\
&= \frac{e^2}{2 \cdot 3(4\pi)^2} \left(\frac{(p^2 + 4m^2)^{3/2}}{(-p^2)^{3/2}} 2 \arctan \frac{\sqrt{-p^2}}{\sqrt{p^2 + 4m^2}} \right. \\
&\quad \left. - \frac{2}{3} - 2 \left(\frac{4m^2}{p^2} + 1 \right) \right), \quad -4m^2 < p^2 < 0; \\
&= \frac{e^2}{2 \cdot 3(4\pi)^2} \left(\frac{(-p^2 - 4m^2)^{3/2}}{(-p^2)^{3/2}} \left(\log \frac{\sqrt{-p^2 - 4m^2} + \sqrt{-p^2}}{\sqrt{-p^2 - 4m^2} - \sqrt{-p^2}} - i\pi \right) \right. \\
&\quad \left. - \frac{2}{3} - 2 \left(\frac{4m^2}{p^2} + 1 \right) \right), \quad p^2 < -4m^2.
\end{aligned}$$

5.2.12 Renormalization of the vacuum energy

Note that the Fourier transform of the electromagnetic field is

$$F_{\mu\nu}(p) = p_\mu A_\nu(p) - p_\nu A_\mu(p). \quad (5.50)$$

Hence

$$-\overline{F_{\mu\nu}(p)} F^{\mu\nu}(p) = -p^2 |A(p)|^2 + |pA(p)|^2. \quad (5.51)$$

Thus the renormalized 1st order contribution to the vacuum energy is

$$\mathcal{E}_1^{\text{ren}} = - \int \frac{dp}{(2\pi)^4} \Pi^{\text{ren}}(p^2) \overline{F_{\mu\nu}(p)} F^{\mu\nu}(p). \quad (5.52)$$

We can formally write $\Pi_\infty^{\text{gi}}(k) := \lim_{\Lambda \rightarrow \infty} \Pi_\Lambda^{\text{gi}}(k)$ (which is typically infinite).

Note that the renormalized scattering operator \hat{S}_{ren} is a well defined unitary operator:

$$\hat{S}_{\text{ren}} = e^{-i\Pi_\infty^{\text{gi}}(0) \int F_{\mu\nu}(x) F^{\mu\nu}(x) dx} \hat{S}. \quad (5.53)$$

However, there is no correctly defined renormalized Hamiltonian. Formally, the correct Lagrangian density is obtained by replacing $\mathcal{L}(x)$ with

$$\mathcal{L}_{\text{ren}}(x) = \mathcal{L}(x) - \Pi_\infty^{\text{gi}}(0) F_{\mu\nu}(x) F^{\mu\nu}(x).$$

5.2.13 Method of dispersion relations

There exists an alternative method to renormalize and compute the vacuum energy. We start with computing just the imaginary part of the gauge invariant vacuum energy function, which does not require a regularization, so that we obtain $\text{Im}\Pi^{\text{ren}}(p^2)$ from the very beginning:

$$\begin{aligned}\text{Im}\Pi^{\text{ren}}(p^2) &= \frac{e^2}{2(4\pi)^2} \int_0^1 dv v^2 (-\pi) \theta\left(-1 - \frac{(1-v^2)p^2}{4m^2}\right) \\ &= -\frac{e^2}{2 \cdot 3(4\pi)^2} \frac{\pi}{(-p^2)^{3/2}} \Big|_{-p^2 - 4m^2}^{\frac{3}{2}}.\end{aligned}\quad (5.54)$$

As in (2.118), using $\Pi^{\text{ren}}(0) = 0$ and Thm A.4 we obtain

$$\Pi^{\text{ren}}(p^2) = \frac{1}{\pi} \int_{-\infty}^{-4m^2} ds \text{Im}\Pi^{\text{ren}}(s) \left(\frac{1}{s-p^2} - \frac{1}{s}\right).\quad (5.55)$$

Note that (5.54) is nonzero only for $p^2 < -4m^2$, and then it is negative. For such p we can find a coordinate system with $p = (p^0, \vec{0})$. Then

$$-g_{\mu\nu}p^2 + p_\mu p_\nu = p_0^2(g_{\mu\nu} + \delta_{\mu 0}\delta_{0\nu})$$

and

$$-\overline{F_{\mu\nu}(p^0, \vec{0})} F^{\mu\nu}(p^0, \vec{0}) = p_0^2 |\vec{A}(p^0, \vec{0})|^2.\quad (5.56)$$

Thus the imaginary part of (5.52) is negative (and is responsible for the decay).

5.2.14 Dimensional renormalization

We present an alternative computation of $\Pi_{\mu\nu}^{\text{ren}}$ based on the dimensional regularization. We use the Euclidean formalism.

$$\begin{aligned}2\Pi_{\mu\nu}^{\text{E}}(p) &= -e^2 \int \frac{d^4q}{(2\pi)^4} \left(\frac{4q_\mu q_\nu}{((q + \frac{1}{2}p)^2 + m^2)((q - \frac{1}{2}p)^2 + m^2)} \right. \\ &\quad \left. - \frac{2g_{\mu\nu}}{q^2 + m^2} \right) \\ &= -e^2 \int \frac{d^4q}{(2\pi)^4} \frac{4q_\mu q_\nu - 2g_{\mu\nu}(q^2 + \frac{1}{4}p^2 + m^2)}{((q + \frac{1}{2}p)^2 + m^2)((q - \frac{1}{2}p)^2 + m^2)} \\ &= -\frac{e^2}{2} \int_{-1}^1 dv \int \frac{d^4q}{(2\pi)^4} \frac{4q_\mu q_\nu - 2g_{\mu\nu}(q^2 + \frac{1}{4}p^2 + m^2)}{(q^2 + \frac{v^2}{4} + m^2 + vqp)^2} \\ &= -e^2 \int_0^1 dv \int \frac{d^4q}{(2\pi)^4} \frac{4q_\mu q_\nu - 2g_{\mu\nu}(q^2 + \frac{1}{4}p^2 + m^2) + v^2(p_\mu p_\nu - g_{\mu\nu} \frac{p^2}{2})}{(q^2 + \frac{v^2}{4}(1-v^2) + m^2)^2},\end{aligned}\quad (5.57)$$

where we used the Feynman identity (A.28), replaced $q + \frac{vp}{2}$ with q , used the symmetry $v \rightarrow -v$ to remove $\int_{-1}^1 dv v$ and replace $\frac{1}{2} \int_{-1}^1 dv$ with $\int_0^1 dv$. After

this preparation, we use the dimensional regularization:

$$\int \frac{d^4 q}{(2\pi)^4} \text{ is replaced by } \frac{\mu^{4-d}\Omega_d}{(2\pi)^d} \int_0^\infty |q|^{d-1} d|q|, \quad (5.58)$$

$$\int \frac{q_\mu q_\nu d^4 q}{(2\pi)^4} \text{ is replaced by } \frac{\mu^{4-d}\Omega_d}{d(2\pi)^d} g_{\mu\nu} \int_0^\infty |q|^{d+1} d|q|, \quad (5.59)$$

where Ω_d is given by (A.30). Thus (5.57) is replaced by

$$\begin{aligned} \Pi_{\mu\nu}^{\text{E},d}(p) &= -e^2 \frac{\mu^{4-d}\Omega_d}{(2\pi)^d} \int_0^1 dv \int_0^\infty |q|^{d-1} d|q| \\ &\quad \times \frac{\left((4/d-2)g_{\mu\nu}q^2 - 2g_{\mu\nu}(\frac{1}{4}p^2 + m^2) + v^2(p_\mu p_\nu - g_{\mu\nu}\frac{p^2}{2}) \right)}{\left(q^2 + \frac{p^2}{4}(1-v^2) + m^2 \right)^2} \\ &= -\frac{e^2}{(4\pi)^2} \int_0^1 dv \left(\frac{\mu^2 4\pi}{\frac{p^2}{4}(1-v^2) + m^2} \right)^{2-d/2} \Gamma(2-d/2) \\ &\quad \times \left(2g_{\mu\nu} \left(\frac{p^2}{4}(1-v^2) + m^2 \right) - 2g_{\mu\nu} \left(\frac{1}{4}p^2 + m^2 \right) + v^2 \left(p_\mu p_\nu - g_{\mu\nu} \frac{p^2}{2} \right) \right) \\ &= -\frac{e^2}{(4\pi)^2} \int_0^1 dv \left(\frac{\mu^2 4\pi}{\frac{p^2}{4}(1-v^2) + m^2} \right)^{2-d/2} \Gamma(2-d/2) v^2 (p_\mu p_\nu - g_{\mu\nu} p^2) \\ &\simeq -\frac{e^2}{(4\pi)^2} \int_0^1 dv \left(-\gamma + \log \mu^2 4\pi - \log \left(\frac{p^2}{4}(1-v^2) + m^2 \right) \right) v^2 (p_\mu p_\nu - g_{\mu\nu} p^2) \\ &\quad - \frac{e^2}{3(4\pi)^2 (2-d/2)} (p_\mu p_\nu - g_{\mu\nu} p^2) \end{aligned} \quad (5.60)$$

We can now renormalize (5.60):

$$\begin{aligned} &\Pi^{\text{E,ren}}(p^2)(p_\mu p_\nu - g_{\mu\nu} p^2) \\ &= \lim_{d \rightarrow 4} \left(\Pi_{\mu\nu}^{\text{E},d}(p^2) - \Pi_{\mu\nu}^{\text{E},d}(0) \right) \\ &= \frac{1}{2(4\pi)^2} \int_0^1 dv v^2 \log \left(1 + \frac{p^2}{4m^2}(1-v^2) \right) (p_\mu p_\nu - g_{\mu\nu} p^2). \end{aligned}$$

This coincides with the Wick rotated result obtained by the Pauli-Villars method.

5.2.15 Abstract gauge covariance

Let us adopt for a moment an abstract setting. Let $\mathbb{R} \ni t \mapsto \hat{H}(t)$ be a time-dependent Hamiltonian generating the dynamics

$$\hat{U}(t_+, t_-) := \text{Texp} \left(-i \int_{t_-}^{t_+} \hat{H}(s) ds \right).$$

Let $t \mapsto \hat{W}(t)$ be a family of unitary operators that have the interpretation of time dependent *gauge transformations*. We will assume that $\hat{W}(t)$ converges to

identity as $t \rightarrow \pm\infty$ and is generated by a time dependent family of self-adjoint operators $t \mapsto \hat{R}(t)$, so that

$$\hat{W}(t) := \text{Texp}\left(-i \int_{-\infty}^t \hat{R}(s) ds\right).$$

Then

$$\hat{W}(t_+) \hat{U}(t_+, t_-) \hat{W}^*(t_-) = \text{Texp}\left(-i \int_{t_-}^{t_+} \hat{H}_R(s) ds\right),$$

where the *gauge-transformed Hamiltonian* is

$$\hat{H}_R(t) := \hat{W}(t) \hat{H}(t) \hat{W}^*(t) + \hat{R}(t). \quad (5.61)$$

5.2.16 Ward identities

Let us go back to the setting of quantized charged scalar fields. The gauge invariance implies strong conditions on the scattering operator and Green's functions.

Let $\hat{S}(A)$ denote the scattering operator for the external 4-potential A . Let χ be a Schwartz function on $\mathbb{R}^{1,3}$. It is easy to see that the scattering operator is gauge-invariant:

$$\hat{S}(A) = \hat{S}(A + \partial\chi). \quad (5.62)$$

Differentiating this identity w.r.t. χ and setting $\chi = 0$ we obtain the *Ward(-Takahashi) identities for the scattering operator* in the position representation:

$$\partial_{y_\mu} \frac{\partial}{\partial A_\mu(y)} \hat{S}(A) = 0.$$

In the momentum representation these identities read

$$p_\mu \frac{\partial}{\partial A_\mu(p)} \hat{S}(A) = 0.$$

We will write $\langle \hat{\psi}^*(x'_1) \cdots \hat{\psi}^*(x'_N) \hat{\psi}(x_N) \cdots \hat{\psi}(x_1) \rangle_A$ to express the dependence of Green's functions on the external 4-potential A . We have

$$\begin{aligned} & \langle \hat{\psi}^*(x'_1) \cdots \hat{\psi}^*(x'_N) \hat{\psi}(x_N) \cdots \hat{\psi}(x_1) \rangle_{A+\partial\chi} \\ &= \langle \hat{\psi}^*(x'_1) \cdots \hat{\psi}^*(x'_N) \hat{\psi}(x_N) \cdots \hat{\psi}(x_1) \rangle_A e^{ie\chi(x'_1) + \cdots + ie\chi(x'_N) - ie\chi(x_N) - \cdots - ie\chi(x_1)}. \end{aligned} \quad (5.63)$$

By differentiating with respect to $\chi(y)$ and setting $\chi = 0$ we obtain the *Ward(-Takahashi) identities for Green's functions* in the position representation:

$$\begin{aligned} & \partial_{y_\mu} \frac{\partial}{\partial A_\mu(y)} \langle \hat{\psi}^*(x'_1) \cdots \hat{\psi}^*(x'_N) \hat{\psi}(x_N) \cdots \hat{\psi}(x_1) \rangle_A \\ &= \left(i \sum_{j=1}^N \delta(y - x'_j) - i \sum_{j=1}^N \delta(y - x_j) \right) \langle \hat{\psi}^*(x'_1) \cdots \hat{\psi}^*(x'_N) \hat{\psi}(x_N) \cdots \hat{\psi}(x_1) \rangle_A. \end{aligned}$$

In the momentum representation these identities read

$$\begin{aligned}
& q_\mu \frac{\partial}{\partial A_\mu(q)} \langle \hat{\psi}^*(p'_1) \cdots \hat{\psi}^*(p'_N) \hat{\psi}(p_N) \cdots \hat{\psi}(p_1) \rangle_A \\
&= \sum_{j=1}^N \langle \hat{\psi}^*(p'_1) \cdots \hat{\psi}^*(p'_j - q) \cdots \hat{\psi}^*(p'_N) \hat{\psi}(p_N) \cdots \hat{\psi}(p_1) \rangle_A + \\
&\quad - \sum_{j=1}^N \langle \hat{\psi}^*(p'_1) \cdots \hat{\psi}^*(p'_N) \hat{\psi}(p_N) \cdots \hat{\psi}(p_j + q) \cdots \hat{\psi}(p_1) \rangle_A.
\end{aligned}$$

(5.62) and (5.63) are essentially obvious if we use the path integral expressions. It is instructive to derive these statements also in the Hamiltonian formalism. This derivation is not fully rigorous, since transformations cannot be implemented, and in general the dynamics does not have a well defined Hamiltonian.

Formally, we define the gauge transformation as a unitary operator

$$\begin{aligned}
\hat{W}(\chi, t) &:= \exp\left(-ie \int d\vec{x} \chi(t, \vec{x}) \hat{\mathcal{Q}}(\vec{x})\right) \\
&= \exp\left(-ie \int_{-\infty}^t ds \int d\vec{x} \dot{\chi}(s, \vec{x}) \hat{\mathcal{Q}}(\vec{x})\right) \quad (5.64) \\
&= \text{Texp}\left(-ie \int_{-\infty}^t ds \int d\vec{x} \dot{\chi}(s, \vec{x}) \hat{\mathcal{Q}}(\vec{x})\right).
\end{aligned}$$

To see the second identity it is enough to note that $[\hat{\mathcal{Q}}(\vec{x}), \hat{\mathcal{Q}}(\vec{y})] = 0$, hence we can replace Texp with exp in (5.64). Clearly,

$$\begin{aligned}
\hat{W}(\chi, t) \hat{\psi}(\vec{x}) \hat{W}(\chi, t)^* &= e^{i\chi(t, \vec{x})} \hat{\psi}(\vec{x}), \\
\hat{W}(\chi, t) \hat{\eta}(\vec{x}) \hat{W}(\chi, t)^* &= e^{i\chi(t, \vec{x})} \hat{\eta}(\vec{x}).
\end{aligned}$$

Let $\hat{H}(A, t)$ denote (5.42), that is the Schrödinger picture Hamiltonian. Let $\hat{U}(A, t_+, t_-)$ be the corresponding dynamics.

$$\begin{aligned}
& \hat{W}(\chi, t) \hat{H}(t, A) \hat{W}(\chi, t)^* + e \int \dot{\chi}(t, \vec{x}) \hat{\mathcal{Q}}(\vec{x}) d\vec{x} \\
&= \int d\vec{x} \left(\hat{\eta}^*(\vec{x}) \hat{\eta}(\vec{x}) - ie(A_0(t, \vec{x}) + \dot{\chi}(t, \vec{x})) : (\hat{\psi}^*(\vec{x}) \hat{\eta}(\vec{x}) - \hat{\eta}^*(\vec{x}) \hat{\psi}(\vec{x})) : \right. \\
&\quad \left. + (\partial_i - ieA_i(t, \vec{x})) e^{ie\chi(t, \vec{x})} \hat{\psi}^*(\vec{x}) (\partial_i + ieA_i(t, \vec{x})) e^{-ie\chi(t, \vec{x})} \hat{\psi}(\vec{x}) \right. \\
&\quad \left. + m^2 \hat{\psi}^*(\vec{x}) \hat{\psi}(\vec{x}) \right) \\
&= \hat{H}(t, A + \partial\chi).
\end{aligned}$$

Therefore, by (5.61), we have the following identity, which expresses the gauge covariance:

$$\hat{W}(\chi, t_+) \hat{U}(A, t_+, t_-) \hat{W}^*(\chi, t_-) = \hat{U}(A + \partial\chi, t_+, t_-). \quad (5.65)$$

Using that $\lim_{t \rightarrow \pm\infty} \hat{W}(\chi, t) = \mathbb{1}$, we obtain

$$\begin{aligned} \hat{S}(A + \partial\chi) &= \lim_{t_+, -t_- \rightarrow \infty} e^{it_+ \hat{H}_0} \hat{U}(A + \partial\chi, t_+, t_-) e^{-it_- \hat{H}_0} \\ &= \lim_{t_+, -t_- \rightarrow \infty} e^{it_+ \hat{H}_0} \hat{W}(\chi, t_+) \hat{U}(A, t_+, t_-) \hat{W}(\chi, t_-)^* e^{-it_- \hat{H}_0} \\ &= \hat{S}(A), \end{aligned}$$

which implies (5.62). (5.63) is a consequence of (5.65).

5.2.17 Energy shift

Suppose that the 4-potential does not depend on time and is given by a Schwartz function $\mathbb{R}^3 \ni \vec{x} \mapsto A(\vec{x}) = [A_\mu(\vec{x})]$. We assume that $A_0^2 \leq m^2$. The naive (Weyl ordered) Hamiltonian is

$$\begin{aligned} \hat{H} &= \int d\vec{x} \left(\hat{\eta}^*(\vec{x}) \hat{\eta}(\vec{x}) + ieA_0(\vec{x}) : (\hat{\psi}^*(\vec{x}) \hat{\eta}(\vec{x}) - \hat{\eta}^*(\vec{x}) \hat{\psi}(\vec{x})) : \right. \\ &\quad \left. + (\partial_i - ieA_i(\vec{x})) \hat{\psi}^*(\vec{x}) (\partial_i + ieA_i(\vec{x})) \hat{\psi}(\vec{x}) \right. \\ &\quad \left. + m^2 \hat{\psi}^*(\vec{x}) \hat{\psi}(\vec{x}) \right). \end{aligned} \quad (5.66)$$

It can be compared with the Weyl ordered free Hamiltonian (5.43). We can apply the formula (A.17) to compute the naive energy shift (the difference between the ground state energies of \hat{H} and \hat{H}_{fr}):

$$\begin{aligned} &\text{Tr} \left(\sqrt{-(\vec{\partial} + ie\vec{A})^2 + m^2 - e^2 A_0^2} - \sqrt{-\vec{\partial}^2 + m^2} \right) \\ &=: \sum_{n=1}^{\infty} e^{2n} E_n. \end{aligned}$$

In the above sum all the terms with $n \geq 2$ are well defined. The term with $n = 1$ needs renormalization. The renormalized energy shift is

$$E^{\text{ren}} = -e^2 \int \Pi^{\text{ren}}(\vec{p}^2) \overline{F_{\mu\nu}(\vec{p})} F^{\mu\nu}(\vec{p}) \frac{d\vec{p}}{(2\pi)^3} + \sum_{n=2}^{\infty} e^{2n} E_n,$$

where Π^{ren} was introduced in (5.49).

6 Dirac fermions

In this section we study the *Dirac equation*

$$(-i\gamma^\mu \partial_\mu + m)\psi(x) = 0$$

and its quantization. Here, $m \geq 0$ and γ^μ are *Dirac matrices*.

Note that the Dirac equation is complex, and therefore it describes charged particles. In particular, one can consider the Dirac equation in the presence of an external electromagnetic 4-potential $A(x) = [A^\mu(x)]$:

$$(\gamma^\mu(-i\partial_\mu + eA_\mu(x)) + m)\psi(x) = 0.$$

The theory of Dirac fermions is in many ways parallel to the theory of charged scalar bosons described in Sect. 5.

6.1 Free Dirac fermions

6.1.1 Dirac spinors

We adopt the following conventions for Dirac matrices γ^μ , $\mu = 0, \dots, 3$:

$$\begin{aligned} [\gamma^\mu, \gamma^\nu]_+ &= -2g^{\mu\nu}, \\ \gamma^{0*} &= \gamma^0, \quad \gamma^{i*} = -\gamma^i, \quad i = 1, 2, 3. \end{aligned}$$

Sometimes we will also need

$$\gamma^5 := -i\gamma^0\gamma^1\gamma^2\gamma^3.$$

It satisfies

$$[\gamma^5, \gamma^\mu]_+ = 0, \quad (\gamma^5)^2 = \mathbb{1}, \quad \gamma^{5*} = \gamma^5.$$

All irreducible representations of Dirac matrices are equivalent and act on the space \mathbb{C}^4 . One of the most common is the so-called *Dirac representation*

$$\begin{aligned} \gamma^0 &= \begin{bmatrix} 1 & 0 \\ 0 & -1 \end{bmatrix}, \quad \vec{\gamma} = \begin{bmatrix} 0 & \vec{\sigma} \\ -\vec{\sigma} & 0 \end{bmatrix}, \\ \gamma^5 &= \begin{bmatrix} 0 & 1 \\ 1 & 0 \end{bmatrix}. \end{aligned}$$

Here is the *Majorana representation*:

$$\begin{aligned} \gamma^0 &= i \begin{bmatrix} 0 & -1 \\ 1 & 0 \end{bmatrix}, \quad \gamma^1 = i \begin{bmatrix} 0 & \sigma_1 \\ \sigma_1 & 0 \end{bmatrix}, \quad \gamma^2 = i \begin{bmatrix} -1 & 0 \\ 0 & 1 \end{bmatrix}, \quad \gamma^3 = i \begin{bmatrix} 0 & \sigma_3 \\ \sigma_3 & 0 \end{bmatrix}, \\ \gamma^5 &= - \begin{bmatrix} 0 & \sigma_2 \\ \sigma_2 & 0 \end{bmatrix}, \end{aligned}$$

and the *spinor representation*:

$$\begin{aligned} \gamma^0 &= \begin{bmatrix} 0 & 1 \\ 1 & 0 \end{bmatrix}, \quad \vec{\gamma} = \begin{bmatrix} 0 & -\vec{\sigma} \\ \vec{\sigma} & 0 \end{bmatrix}, \\ \gamma^5 &= \begin{bmatrix} 1 & 0 \\ 0 & -1 \end{bmatrix}. \end{aligned}$$

Above we used the *Pauli matrices* $\vec{\sigma} = (\sigma_1, \sigma_2, \sigma_3)$ defined by

$$\sigma_1 = \begin{bmatrix} 0 & 1 \\ 1 & 0 \end{bmatrix}, \quad \sigma_2 = \begin{bmatrix} 0 & -i \\ i & 0 \end{bmatrix}, \quad \sigma_3 = \begin{bmatrix} 1 & 0 \\ 0 & -1 \end{bmatrix}.$$

They satisfy $\sigma_i \sigma_j = 2\epsilon_{ijk} \sigma_k$.

Note useful (representation independent) *trace identities*:

$$\begin{aligned}\text{Tr} \mathbb{1} &= 4, \\ \text{Tr}(a\gamma)(b\gamma) &= -4ab, \\ \text{Tr}(a\gamma)(b\gamma)(c\gamma)(d\gamma) &= 4(ab)(cd) - 4(ac)(bd) + 4(ad)(bc).\end{aligned}$$

We also introduce the *spin operators*

$$\sigma^{\mu\nu} := \frac{i}{2}[\gamma^\mu, \gamma^\nu].$$

In the Dirac representation

$$\begin{aligned}\sigma^{0i} &= \begin{bmatrix} 0 & i\sigma^i \\ i\sigma^i & 0 \end{bmatrix}, \\ \sigma^{ij} &= \epsilon^{ijk} \begin{bmatrix} \sigma_k & 0 \\ 0 & \sigma_k \end{bmatrix}.\end{aligned}\tag{6.1}$$

The operators $\sigma^{\mu\nu}$ form a representation of the Lie algebra $so(1, 3) = spin(1, 3)$. It is the infinitesimal version of the representation

$$Spin^\uparrow(1, 3) \ni \tilde{\Lambda} \mapsto \tau(\tilde{\Lambda}).$$

6.1.2 Special solutions and Green's functions

Note the identity

$$-(-i\gamma\partial + m)(-i\gamma\partial - m) = -\square + m^2.$$

Therefore, if

$$(-\square + m^2)\zeta(x) = 0,$$

then $(i\gamma^\mu \partial_\mu + m)\zeta(x)$ is a solution of the homogeneous Dirac equation:

$$(-i\gamma^\mu \partial_\mu + m)(i\gamma^\mu \partial_\mu + m)\zeta(x) = 0.$$

In particular, we have *special solutions* of the homogeneous Dirac equation

$$\begin{aligned}S^{(\pm)}(x) &= (i\gamma\partial + m)D^{(\pm)}(x), \\ S(x) &= (i\gamma\partial + m)D(x),\end{aligned}$$

where $D^{(\pm)}$ and D are the special solutions of the Klein-Gordon equation introduced in Subsubsect. 2.1.1. We have $\text{supp} S \subset J$.

If

$$(-\square + m^2)\zeta(x) = \delta(x),$$

then $(i\gamma^\mu \partial_\mu + m)\zeta(x)$ is a *Green's function* of the Dirac equation, that is

$$(-i\gamma\partial + m)(i\gamma\partial + m)\zeta(x) = \delta(x).$$

In particular, a special role is played by the Green functions

$$\begin{aligned} S^\pm(x) &= (i\gamma\partial + m)D^\pm(x), \\ S^c(x) &= (i\gamma\partial + m)D^c(x), \end{aligned}$$

where D^\pm and D^c are the Green's functions of the Klein-Gordon equation introduced in Subsubsection. 2.1.1. We have $\text{supp}S^\pm \subset J^\pm$.

The *Dirac propagators* satisfy the identities

$$\begin{aligned} S(x) = -S(-x) &= S^{(+)}(x) + S^{(-)}(x) \\ &= S^+(x) - S^-(x), \\ S^{(+)}(x) &= S^{(-)}(-x), \\ S^+(x) = S^-(-x) &= \theta(x^0)S(x), \\ S^-(x) &= \theta(-x^0)S(x), \\ S^c(x) = S^c(-x) &= \theta(x^0)S^{(-)}(x) - \theta(-x^0)S^{(+)}(x). \end{aligned}$$

Recall that the bosonic causal Green's function in the momentum representation can be written as

$$D^c(p) = \frac{1}{p^2 + m^2 - i0}.$$

The Dirac causal Green's function can be written in a similar way:

$$\begin{aligned} S^c(p) &= \frac{-\gamma p + m}{p^2 + m^2 - i0} \\ &= \frac{1}{\gamma p + m - i\epsilon}, \end{aligned} \tag{6.2}$$

where $i\epsilon$ is the shorthand for $i0 \operatorname{sgn} p\gamma$.

6.1.3 Space of solutions

We set $\alpha_i = \gamma^0 \gamma^i$, $i = 1, 2, 3$, and $\beta := \gamma^0$. We obtain matrices satisfying

$$\begin{aligned} \beta^2 &= \mathbb{1}, \quad (\alpha_i)^2 = \mathbb{1}, \quad i = 1, \dots, 3; \\ \beta\alpha_i + \alpha_i\beta &= 0, \quad \alpha_i\alpha_j + \alpha_j\alpha_i = 0, \quad 1 \leq i < j \leq 3; \\ \beta^* &= \beta, \quad \alpha_i^* = \alpha_i, \quad i = 1, \dots, 3. \end{aligned}$$

In the Dirac representation we have

$$\beta = \begin{bmatrix} 1 & 0 \\ 0 & -1 \end{bmatrix}, \quad \vec{\alpha} = \begin{bmatrix} 0 & \vec{\sigma} \\ \vec{\sigma} & 0 \end{bmatrix}.$$

Using $\vec{\alpha}, \beta$ we can rewrite the Dirac equation in the form of an evolution equation:

$$i\partial_t \zeta(t, \vec{x}) = \mathbb{D}\zeta, \quad \mathbb{D} := \vec{\alpha}\vec{p} + m\beta.$$

Note that \mathbb{D} is essentially self-adjoint on $C_c^\infty(\mathbb{R}^3, \mathbb{C}^4)$.

The following theorem describes the *Cauchy problem* for the Dirac equation:

Theorem 6.1 *Let $\vartheta \in C_c^\infty(\mathbb{R}^3, \mathbb{C}^4)$. Then there exists a unique $\zeta \in C_{\text{sc}}^\infty(\mathbb{R}^{1,3})$ that solves the Dirac equation with initial conditions $\zeta(0, \vec{x}) = \vartheta(\vec{x})$. It satisfies $\text{supp}\zeta \subset J(\text{supp}\vartheta)$ and is given by*

$$\zeta(t, \vec{x}) = -i \int_{\mathbb{R}^3} S(t, \vec{x} - \vec{y}) \beta \vartheta(\vec{y}) d\vec{y}. \quad (6.3)$$

Let \mathcal{W}_D be the space of *space-compact solutions of the Dirac equation*, that is $\zeta \in C_{\text{sc}}^\infty(\mathbb{R}^{1,3}, \mathbb{C}^4)$ satisfying $(-i\gamma^\mu \partial_\mu + m)\zeta = 0$.

For $\zeta_1, \zeta_2 \in C^\infty(\mathbb{R}^{1,3}, \mathbb{C}^4)$ set

$$j^\mu(\zeta_1, \zeta_2, x) := \overline{\zeta_1(x)} \beta \gamma^\mu \zeta_2(x). \quad (6.4)$$

We easily check that

$$\partial_\mu j^\mu(x) = \overline{(-i\gamma^\partial + m)\zeta_1(x)} \beta \zeta_2(x) - \overline{\zeta_1(x)} \beta (-i\gamma^\partial + m)\zeta_2(x).$$

Therefore, if $\zeta_1, \zeta_2 \in \mathcal{W}_D$, then j^μ is a *conserved 4-current*:

$$\partial_\mu j^\mu(x) = 0.$$

For $\zeta_1, \zeta_2 \in \mathcal{W}_D$, the flux of j^μ does not depend on the choice of a Cauchy hypersurface \mathcal{S} . It defines a scalar product on \mathcal{W}_D , which will have two optional symbols:

$$\bar{\zeta}_1 \cdot \zeta_2 = (\zeta_1 | \zeta_2) := \int_{\mathcal{S}} j^\mu(\zeta_1, \zeta_2, x) ds_\mu(x).$$

In terms of the Cauchy data this scalar product coincides with the natural scalar product on $L^2(\mathbb{R}^3, \mathbb{C}^4)$:

$$\bar{\zeta}_1 \cdot \zeta_2 = \int \overline{\zeta_1(t, \vec{x})} \zeta_2(t, \vec{x}) d\vec{x}.$$

The group $\mathbb{R}^{1,3} \rtimes \text{Spin}^\uparrow(1, 3)$, acts unitarily on \mathcal{W}_D by

$$r_{(y, \Lambda)} \zeta(x) := \tau(\tilde{\Lambda}) \zeta((y, \Lambda)^{-1}x).$$

We can also parametrize solutions of the Dirac equation by *space-time functions*. In fact, for any $f \in C_c^\infty(\mathbb{R}^{1,3}, \mathbb{C}^4)$, let us write

$$S * f(x) := \int S(x - y) f(y) dx.$$

Theorem 6.2 (1) *For any $f \in C_c^\infty(\mathbb{R}^{1,3}, \mathbb{C}^4)$, $S * f \in \mathcal{W}_D$.*

(2) *Every element of \mathcal{W}_D is of this form.*

(3) $\overline{S * f_1} \cdot S * f_2 = \int \int \overline{f_1(x)} \beta S(x - y) f_2(y) dx dy$.

(4) *If $\text{supp}f_2 \times \text{supp}f_2$, then*

$$\overline{S * f_1} \cdot S * f_2 = 0.$$

6.1.4 Classical fields

We will also consider the space dual to \mathcal{W}_D , denoted $\mathcal{W}_D^\#$. In particular, for $x \in \mathbb{R}^{1,3}$, $\psi(x), \psi^*(x)$ will denote the functionals on \mathcal{W}_D with values in \mathbb{C}^4 , called *classical Dirac fields*, given by

$$\langle \psi(x) | \zeta \rangle := \zeta(x), \quad \langle \psi^*(x) | \zeta \rangle := \overline{\zeta(x)}.$$

By (6.3),

$$\psi(t, \vec{x}) = -i \int S(t, \vec{x} - \vec{y}) \beta \psi(0, \vec{y}) d\vec{y}.$$

It is convenient to introduce the *Dirac conjugate* of the field ψ :

$$\tilde{\psi}(x) := \beta \psi^*(x).$$

(In a large part of the physics literature, $\tilde{\psi}$ is denoted $\bar{\psi}$.)

On $\mathcal{W}_D^\#$ we have the group action $\mathbb{R}^{1,3} \rtimes Spin^\uparrow(1, 3) \ni (y, \tilde{\Lambda}) \mapsto r_{(y, \tilde{\Lambda})}^{\#-1}$:

$$r_{(y, \tilde{\Lambda})}^{\#-1} \psi(x) = \tau(\tilde{\Lambda}^{-1}) \psi(\Lambda x + y).$$

6.1.5 Smeared fields

We can use the scalar product to pair solutions. For $\zeta \in \mathcal{W}_D$, the corresponding *spatially smeared fields* are the functionals on \mathcal{W}_D given by

$$\begin{aligned} \langle \psi((\zeta)) | \rho \rangle &:= \bar{\zeta} \cdot \rho, \\ \langle \psi^*((\zeta)) | \rho \rangle &:= \zeta \cdot \bar{\rho}, \quad \rho \in \mathcal{W}_D. \end{aligned}$$

Clearly, for any t

$$\begin{aligned} \psi((\zeta)) &= \int \overline{\zeta(t, \vec{x})} \psi(t, \vec{x}) d\vec{x}, \\ \psi^*((\zeta)) &= \int \zeta(t, \vec{x}) \psi^*(t, \vec{x}) d\vec{x}. \end{aligned}$$

For $f \in C_c^\infty(\mathbb{R}^{1,3}, \mathbb{C}^4)$, the corresponding *space-time smeared fields* are given by

$$\begin{aligned} \psi[f] &:= \int \overline{f(x)} \psi(x) dx = \psi((S * f)), \\ \psi^*[f] &:= \int f(x) \psi^*(x) dx = \psi^*((S * f)). \end{aligned}$$

6.1.6 Diagonalization of the equations of motion

Let us use the Dirac representation, denoting elements of \mathbb{C}^4 with $\begin{bmatrix} \zeta_\uparrow \\ \zeta_\downarrow \end{bmatrix}$, where $\zeta_\uparrow, \zeta_\downarrow \in \mathbb{C}^2$. After the space-time Fourier transformation the Dirac equation

becomes

$$\begin{aligned} -p^0 \zeta_{\uparrow} + \vec{\sigma} \vec{p} \zeta_{\downarrow} + m \zeta_{\uparrow} &= 0, \\ p^0 \zeta_{\downarrow} - \vec{\sigma} \vec{p} \zeta_{\uparrow} + m \zeta_{\downarrow} &= 0. \end{aligned}$$

This can be rewritten as

$$\begin{aligned} \zeta_{\uparrow} &= -\frac{\vec{\sigma} \vec{p}}{-p^0 + m} \zeta_{\downarrow}, \\ \zeta_{\downarrow} &= \frac{\vec{\sigma} \vec{p}}{p^0 + m} \zeta_{\uparrow}. \end{aligned}$$

Using $(\vec{\sigma} \vec{p})^2 = \vec{p}^2$ we obtain

$$-(p^0)^2 + \vec{p}^2 + m^2 = 0.$$

Set $E(\vec{p}) := \sqrt{\vec{p}^2 + m^2}$, so that $p = (\pm E(\vec{p}), \vec{p})$. Define

$$\chi_+ := \begin{bmatrix} 1 \\ 0 \end{bmatrix}, \quad \chi_- := \begin{bmatrix} 0 \\ 1 \end{bmatrix}.$$

Traditionally, one often introduces the following spinors:

$$\begin{aligned} u(p, \pm 1/2) &= \frac{\sqrt{E+m}}{\sqrt{2E}} \begin{bmatrix} \chi_{\pm} \\ \frac{\vec{\sigma} \vec{p}}{E+m} \chi_{\pm} \end{bmatrix}, \quad p^0 = E(\vec{p}) > 0; \\ u(p, \pm 1/2) &= \frac{\sqrt{E+m}}{\sqrt{2E}} \begin{bmatrix} \frac{\mp \vec{\sigma} \vec{p}}{E+m} \chi_{\pm} \\ \pm \chi_{\pm} \end{bmatrix}, \quad p^0 = -E(\vec{p}) < 0. \end{aligned} \quad (6.5)$$

Note that

$$\begin{aligned} (u(p, s) | u(p, s')) &= \delta_{s, s'}, \\ (u(p, s) | u(-p, s')) &= 0. \end{aligned}$$

The basic *plane waves* are defined as

$$|p, s\rangle = \frac{1}{\sqrt{(2\pi)^3}} u(p, s) e^{ipx}.$$

By writing $\langle p, s |$, as usual, we will imply the complex conjugation. We have

$$\begin{aligned} \langle p, s | p', s' \rangle &= \delta(\vec{p} - \vec{p}') \delta_{s, s'}, \quad \text{sgn}(p^0 p'^0) > 0, \\ \langle p, s | p', s' \rangle &= 0, \quad \text{sgn}(p^0 p'^0) < 0. \end{aligned}$$

Note that plane waves diagonalize simultaneously the Dirac Hamiltonian \mathbb{D} , the momentum $\vec{p} = -i\vec{\partial}$ and the scalar product:

$$\begin{aligned} \mathbb{D} |p, s\rangle &= p^0 |p, s\rangle, \\ -i\vec{\partial} |p, s\rangle &= \vec{p} |p, s\rangle, \end{aligned}$$

$$\bar{\zeta}_1 \cdot \zeta_2 = \sum_s \int ((\zeta_1|p, s)(p, s|\zeta_2) + (\zeta_1|-p, -s)(-p, -s|\zeta_2)) d\vec{p}.$$

In addition, positive frequency plane waves diagonalize the “upper spin in the 3rd direction” and negative frequency plane waves diagonalize the “lower spin operator in the 3rd direction”:

$$\begin{aligned} \frac{1}{2} \begin{bmatrix} \sigma_3 & 0 \\ 0 & 0 \end{bmatrix} |p, s\rangle &= s|p, s\rangle, \quad \text{sgn}p^0 > 0, \\ \frac{1}{2} \begin{bmatrix} 0 & 0 \\ 0 & \sigma_3 \end{bmatrix} |p, s\rangle &= s|p, s\rangle, \quad \text{sgn}p^0 < 0. \end{aligned}$$

6.1.7 Plane wave functionals

Plane wave functionals are the functionals defined by plane waves. One could doubt whether they deserve a special notation. In the bosonic case the situation was slightly less trivial, because the pairing was given by the symplectic form. For fermions the pairing is given by the scalar product, hence it is straightforward. Anyway, special notation for plane wave functionals is partly motivated as a preparation for quantization.

Let $p \in \mathbb{R}^{1,3}$ with $p^0 > 0$. Anticipating the quantization, we will use different notation for positive and negative frequencies:

$$\begin{aligned} a(p, s) &:= \psi(|p, s\rangle) \\ &= \int \frac{d\vec{x}}{\sqrt{(2\pi)^3}} \overline{u(p, s)} e^{-i\vec{p}\vec{x}} \psi(0, \vec{x}), \end{aligned} \tag{6.6}$$

$$\begin{aligned} b^*(p, s) &:= \psi(|-p, -s\rangle) \\ &= \int \frac{d\vec{x}}{\sqrt{(2\pi)^3}} \overline{u(-p, -s)} e^{i\vec{p}\vec{x}} \psi(0, \vec{x}). \end{aligned} \tag{6.7}$$

We have

$$\begin{aligned} \psi(x) &= \sum_s \int \frac{d\vec{p}}{\sqrt{(2\pi)^3}} (u(p, s) e^{ipx} a(p, s) + u(-p, -s) e^{-ipx} b^*(p, s)) \\ &= \sum_s \int d\vec{p} (|p, s\rangle a(p, s) + |-p, -s\rangle b^*(p, s)). \end{aligned}$$

6.1.8 Positive and negative frequency subspaces

We define

$$\begin{aligned} \mathcal{W}_D^{(+)} &:= \{\zeta \in \mathcal{W}_D : (p, s|\zeta) = 0, \quad p^0 < 0\}, \\ \mathcal{W}_D^{(-)} &:= \{\zeta \in \mathcal{W}_D : (p, s|\zeta) = 0, \quad p^0 > 0\}. \end{aligned}$$

Every $\zeta \in \mathcal{W}_D$ can be uniquely decomposed as $\zeta = \zeta^{(+)} + \zeta^{(-)}$ with $\zeta^{(\pm)} \in \mathcal{W}_D^{(\pm)}$.

On $\mathcal{W}_D^{(+)}$ we keep the old scalar product:

$$(\zeta_1^{(+)}|\zeta_2^{(+)}) = \sum_s \int (\zeta_1^{(+)}|p, s)(p, s|\zeta_2^{(+)})d\vec{p}.$$

We set $\mathcal{Z}_D^{(+)}$ to be the completion of $\mathcal{W}_D^{(+)}$ in this scalar product.

Instead of $\mathcal{W}_D^{(-)}$ for quantization we will use the corresponding complex conjugate space denoted $\overline{\mathcal{W}}_D^{(-)}$ and equipped with the scalar product

$$(\overline{\zeta}_1^{(-)}|\overline{\zeta}_2^{(-)}) := \overline{(\zeta_1^{(-)}|\zeta_2^{(-)})} = \sum_s \int (\overline{\zeta}_1^{(-)}|-\overline{p}, -s)(-\overline{p}, -s|\overline{\zeta}_2^{(-)})d\vec{p}.$$

We set $\mathcal{Z}_D^{(-)}$ to be the completion of $\overline{\mathcal{W}}_D^{(-)}$ in this scalar product.

The action of $\mathbb{R}^{1,3} \rtimes Pin^\uparrow(1, 3)$ leaves $\mathcal{Z}_D^{(+)}$ and $\mathcal{Z}_D^{(-)}$ invariant.

6.1.9 Spin averaging

$\frac{1}{2m}(\mp p\gamma + m)$ are the projections onto the positive and negative energy states resp. With $E = E(\vec{p}) = p^0 > 0$, we have the identities

$$\begin{aligned} \sum_s u(p, s)\tilde{u}(p, s) &= \frac{1}{2E} \begin{bmatrix} E + m & -\vec{\sigma}\vec{p} \\ \vec{\sigma}\vec{p} & -E + m \end{bmatrix} \\ &= \frac{-p\gamma + m}{2E} = \frac{m}{E}\Lambda_+, \\ \sum_s u(-p, -s)\tilde{u}(-p, -s) &= \frac{1}{2E} \begin{bmatrix} E - m & -\vec{\sigma}\vec{p} \\ \vec{\sigma}\vec{p} & -E - m \end{bmatrix} \\ &= \frac{-p\gamma - m}{2E} = -\frac{m}{E}\Lambda_-. \end{aligned}$$

In the following *spin averaging identities* due to H.B.C.Casimir, which are useful in computations of scattering cross-sections, the trace involves only the spin degrees of freedom:

$$\begin{aligned} \sum_{s^+, s^-} |\tilde{u}(p^+, s^+)Bu(p^-, s^-)|^2 &= \frac{\text{Tr}\tilde{B}(-p^+\gamma + m)B(-p^-\gamma + m)}{4E^+E^-}, \\ \sum_{s^+, s^-} |\tilde{u}(-p^+, -s^+)Bu(-p^-, -s^-)|^2 &= \frac{\text{Tr}\tilde{B}(-p^+\gamma - m)B(-p^-\gamma - m)}{4E^+E^-}, \\ \sum_{s^+, s^-} |\tilde{u}(-p^+, -s^+)Bu(p^-, s^-)|^2 &= \frac{\text{Tr}\tilde{B}(-p^+\gamma - m)B(-p^-\gamma + m)}{4E^+E^-}, \\ \sum_{s^+, s^-} |\tilde{u}(p^+, s^+)Bu(-p^-, -s^-)|^2 &= \frac{\text{Tr}\tilde{B}(-p^+\gamma + m)B(-p^-\gamma - m)}{4E^+E^-}, \end{aligned}$$

where B is an arbitrary operator on the spinor space and $\tilde{B} = \beta B^* \beta$ is its pseudo-Hermitian conjugate.

If we specify $B = \beta$, then

$$\begin{aligned} \sum_{s^+, s^-} \left| \overline{u(p^+, s^+)} u(p^-, s^-) \right|^2 &= \sum_{s^+, s^-} \left| \overline{u(-p^+, -s^+)} u(-p^-, -s^-) \right|^2 \\ &= \frac{E^+ E^- + \vec{p}_+^T \vec{p}_-^T + m^2}{E^+ E^-} = \frac{(E^+ + E^-)^2 - |\vec{p}_+^T - \vec{p}_-^T|^2}{2E^+ E^-}, \\ \sum_{s^+, s^-} \left| \overline{u(-p^+, -s^+)} u(p^-, s^-) \right|^2 &= \sum_{s^+, s^-} \left| \overline{u(p^+, s^+)} u(-p^-, -s^-) \right|^2 \\ &= \frac{E^+ E^- + \vec{p}_+^T \vec{p}_-^T - m^2}{E^+ E^-} = \frac{-(E^+ - E^-)^2 + |\vec{p}_+^T + \vec{p}_-^T|^2}{2E^+ E^-}. \end{aligned}$$

6.1.10 Quantization

We would like to describe the quantization of the Dirac equation. As usual, we will use the “hat” to denote quantized objects.

We will use the formalism of quantization of charged fermionic systems [15].

We want to construct $(\mathcal{H}, \hat{H}, \Omega)$ satisfying the standard requirements of QM (1)-(3) and a distribution

$$\mathbb{R}^{1,3} \ni x \mapsto \hat{\psi}(x) \quad (6.8)$$

with values in $\mathbb{C}^4 \otimes B(\mathcal{H})$ such that the following conditions are true:

- (1) $(-i\gamma\partial + m)\hat{\psi}(x) = 0$;
- (2) $[\hat{\psi}_a(0, \vec{x}), \hat{\psi}_b^*(0, \vec{y})]_+ = \delta_{ab}\delta(\vec{x} - \vec{y})$, $[\hat{\psi}_a(0, \vec{x}), \hat{\psi}_b(0, \vec{y})]_+ = 0$;
- (3) $e^{it\hat{H}}\hat{\psi}(x^0, \vec{x})e^{-it\hat{H}} = \hat{\psi}(x^0 + t, \vec{x})$;
- (4) Ω is cyclic for $\hat{\psi}(x)$, $\hat{\psi}^*(x)$.

The above problem has a solution unique up to a unitary equivalence, which we describe below.

We set

$$\mathcal{H} := \Gamma_a(\mathcal{Z}_D^{(+)} \oplus \mathcal{Z}_D^{(-)}).$$

Creation/annihilation operators for the particle space $\mathcal{Z}_D^{(+)} \simeq L^2(\mathbb{R}^3, \mathbb{C}^2)$ are denoted with the letter a and for the antiparticle space $\mathcal{Z}_D^{(-)} \simeq L^2(\mathbb{R}^3, \mathbb{C}^2)$ with the letter b . Thus, for p on the mass shell and $s = \pm\frac{1}{2}$, using physicist's notation on the left and mathematician's on the right, creation operators for particles/antiparticles are written as

$$\hat{a}^*(p, s) = \hat{a}^*(|p, s\rangle), \quad (6.9)$$

$$\hat{b}^*(p, s) = \hat{b}^*(| -p, -s\rangle). \quad (6.10)$$

Ω is the Fock vacuum. The quantum field is

$$\hat{\psi}(x) := \sum_s \int \frac{d\vec{p}}{\sqrt{(2\pi)^3}} \left(u(p, s) e^{ipx} \hat{a}(p, s) + u(-p, -s) e^{-ipx} \hat{b}^*(p, s) \right).$$

The quantum Hamiltonian and momentum are

$$\hat{H} = \int \sum_s \left(\hat{a}^*(p, s) \hat{a}(p, s) + \hat{b}^*(p, s) \hat{b}(p, s) \right) E(\vec{p}) d\vec{p}, \quad (6.11)$$

$$\vec{\hat{P}} = \int \sum_s \left(\hat{a}^*(p, s) \hat{a}(p, s) + \hat{b}^*(p, s) \hat{b}(p, s) \right) \vec{p} d\vec{p}. \quad (6.12)$$

We also have the *charge operator*

$$\hat{Q} := \sum_s \int \left(\hat{a}^*(\vec{p}, s) \hat{a}(\vec{p}, s) - \hat{b}^*(\vec{p}, s) \hat{b}(\vec{p}, s) \right) d\vec{p}. \quad (6.13)$$

The whole group $\mathbb{R}^{1,3} \times Spin^\uparrow(1, 3)$ acts unitarily on \mathcal{H} . Moreover, if we set $\tilde{\hat{\psi}}(x) := \beta \hat{\psi}^*(x)$, then

$$[\hat{\psi}_a(x), \tilde{\hat{\psi}}_b(y)]_+ = S_{ab}(x - y), \quad [\hat{\psi}_a(x), \hat{\psi}_b(y)]_+ = 0. \quad (6.14)$$

We have

$$\begin{aligned} (\Omega | \hat{\psi}_a(x) \tilde{\hat{\psi}}_b(y) \Omega) &= S_{ab}^{(+)}(x - y), \\ (\Omega | T(\hat{\psi}_a(x) \tilde{\hat{\psi}}_b(y)) \Omega) &= S_{ab}^c(x - y). \end{aligned}$$

For $f \in C_c^\infty(\mathcal{O}, \mathbb{C}^4)$ we set

$$\begin{aligned} \hat{\psi}[f] &:= \int \overline{f(x)} \hat{\psi}(x) dx, \\ \hat{\psi}^*[f] &:= \int \overline{f(x)} \hat{\psi}^*(x) dx. \end{aligned}$$

We obtain an operator valued distribution satisfying the Wightman axioms with $\mathcal{D} := \Gamma_a^{\text{fin}}(\mathcal{Z}_D^{(+)} \oplus \mathcal{Z}_D^{(-)})$.

For an open set $\mathcal{O} \subset \mathbb{R}^{1,3}$ the field algebra is defined as

$$\mathfrak{F}(\mathcal{O}) := \{ \hat{\psi}^*[f], \hat{\psi}[f] : f \in C_c^\infty(\mathcal{O}, \mathbb{C}^4) \}''.$$

The observable algebra $\mathfrak{A}(\mathcal{O})$ is the subalgebra of $\mathfrak{F}(\mathcal{O})$ fixed by the automorphism

$$B \mapsto e^{i\theta \hat{Q}} B e^{-i\theta \hat{Q}},$$

where \hat{Q} will be defined in (6.13). The nets of algebras $\mathfrak{F}(\mathcal{O})$ and $\mathfrak{A}(\mathcal{O})$, $\mathcal{O} \subset \mathbb{R}^{1,3}$, satisfy the Haag-Kastler axioms.

6.1.11 Quantization in terms of smeared fields

There exists an alternative equivalent formulation of the quantization program, which uses the smeared fields instead of point fields. Instead of (2.38) we look for an antilinear function

$$\mathcal{W}_D \ni \zeta \mapsto \hat{\psi}(\zeta)$$

with values in bounded operators such that

- (1) $[\hat{\psi}((\zeta_1)), \hat{\psi}^*((\zeta_2))]_+ = \bar{\zeta}_1 \cdot \zeta_2, \quad [\hat{\psi}((\zeta_1)), \hat{\psi}((\zeta_2))]_+ = 0.$
- (2) $\hat{\psi}((r_{(t,\vec{0})}\zeta)) = e^{it\hat{H}}\hat{\psi}((\zeta))e^{-it\hat{H}}.$
- (3) Ω is cyclic for $\hat{\psi}((\zeta)), \hat{\psi}^*((\zeta)).$

One can pass between these two kinds of quantization by

$$\hat{\psi}((\zeta)) = \int \overline{\zeta(t, \vec{x})} \hat{\psi}(t, \vec{x}) d\vec{x}. \quad (6.15)$$

6.1.12 Dirac sea quantization

When we quantized a fermionic field we demanded that the quantum Hamiltonian \hat{H} be positive. In the bosonic case this condition can be dropped if we start from a positive classical Hamiltonian H . Usually this suffices to guarantee the positivity of \hat{H} . (If we start from a classical Hamiltonian that is not positive definite, the bosonic quantum counterpart has no chances of being positive).

Suppose now that we drop the positivity requirement of \hat{H} in the fermionic case. Then we have many possible quantizations. Among them one is distinguished – it is just the usual *second quantization*. It means that we consider the antisymmetric Fock space $\Gamma_a(\mathcal{W}_D^{\text{cpl}})$, where $\mathcal{W}_D^{\text{cpl}}$ denotes the completion of \mathcal{W}_D in its natural scalar product.

The Hilbert space $\mathcal{W}_D^{\text{cpl}}$ is equipped with a distinguished family of commuting self-adjoint operators: the Dirac operator \mathbb{D} and the momentum operator $-i\vec{\partial}$. We can second quantize them using the operation $d\Gamma$ obtaining the operators on $\Gamma_a(\mathcal{W}_D^{\text{cpl}})$, the Hamiltonian and the momentum

$$H = d\Gamma(\mathbb{D}), \quad (6.16)$$

$$\vec{P} = d\Gamma(-i\vec{\partial}). \quad (6.17)$$

The number operator will be rebaptized as the *charge* and denoted

$$Q = d\Gamma(\mathbb{1}).$$

(Let us stress that we do not use “hats” in the above notation).

Let us reinterpret $\psi^*(x)/\psi(x)$ (without “hats”) as the creation/annihilation operators on the space $\Gamma_a(\mathcal{W}_D^{\text{cpl}})$. As in (6.14), they satisfy

$$[\psi_a(x), \tilde{\psi}_b(y)]_+ = S_{ab}(x - y), \quad [\psi_a(x), \psi_b(y)]_+ = 0. \quad (6.18)$$

The plane wave functionals $a(p, s)$, $a^*(p, s)$, $b(p, s)$, $b^*(p, s)$ defined as in (6.6) and (6.7) in terms of $\psi(x)$, $\psi^*(x)$, can be used to diagonalize the Hamiltonian, momentum and charge

$$H = \int \sum_s (a^*(p, s)a(p, s) - b(p, s)b^*(p, s)) E(\vec{p}) d\vec{p}, \quad (6.19)$$

$$\vec{P} = \int \sum_s (a^*(p, s)a(p, s) - b(p, s)b^*(p, s)) \vec{p} d\vec{p}, \quad (6.20)$$

$$Q = \int \sum_s (a^*(p, s)a(p, s) + b(p, s)b^*(p, s)) \vec{p} d\vec{p}. \quad (6.21)$$

The vacuum of $\Gamma_a(\mathcal{W}_D^{\text{cpl}})$ is annihilated by $\psi(x)$, hence also by $a(p, s)$ and $b^*(p, s)$. It is the state of the lowest charge possible. Therefore, it will be called the *bottom of the Dirac sea*. We will call the above described procedure the *Dirac sea quantization*.

The reader should compare the formulas for H (6.19), \vec{P} (6.20) and Q (6.21) with \hat{H} (6.11), $\vec{\hat{P}}$ (6.12) and \hat{Q} (6.13). They differ only by the order of a part of field operators. So formally they coincide modulo an (infinite) additive constant.

The usual quantization, called the *positive energy quantization* and the Dirac sea quantization are just two inequivalent representations of canonical anticommutation relations. If \mathcal{W}_D had a finite dimension (which can be accomplished by applying both an infrared and ultraviolet cutoff), then the Dirac sea quantization would be unitarily equivalent with the positive energy quantization by the procedure invented by Dirac and called often *filling the Dirac sea*. The Hamiltonians H and \hat{H} , and as we see later, the charges Q and \hat{Q} would differ by a finite constant. The momenta \vec{P} and $\vec{\hat{P}}$ would coincide.

6.1.13 Fermionic Hamiltonian formalism

Bosonic quantum fields can be interpreted as a quantization of a classical system. In the Hamiltonian (on-shell) formalism this system is described by an appropriate symplectic space. In the charged case, the symplectic space can be viewed as a complex space and instead of the symplectic structure it is natural to consider an appropriate Hermitian form. The spaces \mathcal{Y}_{KG} and \mathcal{W}_{KG} were examples of such spaces. Symmetries are described by symplectic transformations. The dynamics is generated by a (classical) Hamiltonian – a function on the symplectic space.

An important element of the Hamiltonian formalism is the “algebra of classical observables” – the commutative algebra of functions on the symplectic space equipped with the Poisson bracket. One can ask whether there exists an analogous structure behind fermionic quantum fields.

Clearly, the space \mathcal{W}_D , which is equipped with a scalar product, is the obvious fermionic analog of a (complex) symplectic space from the bosonic case. The fermionic analog of the “algebra of classical observables” considered in the literature, eg. [51], is the \mathbb{Z}_2 -graded algebra of operators on $\Gamma_a(\mathcal{W}_D^{\text{cpl}})$ equipped with the *graded commutator*.

The space $\Gamma_a(\mathcal{W}_D^{\text{cpl}})$ is equipped with the *fermionic parity* operator, which we denote by $I := (-\mathbb{1})^Q$. An operator A satisfying $IAI = \pm A$ will be called even/odd. Operators that are either even or odd will be called *homogeneous*. If A is homogeneous we will write $|A| = 0$ if A is even and $|A| = 1$ if A is odd. The analog of the Poisson bracket is the graded commutator:

$$\{A, B\} := AB - (-1)^{|A||B|}BA. \quad (6.22)$$

Note that $\psi(x)$, $\psi^*(x)$ are odd operators and for such operators $\{\cdot, \cdot\}$ coincides with the anticommutator. Thus, to make (6.18) look “classical”, we can replace $[\cdot, \cdot]_+$ with $\{\cdot, \cdot\}$ in this identity.

Note that the “classical” version of the Dirac theory has a quantum character. In particular, the “classical fermionic algebra” is an algebra of operators on a Hilbert space and symmetries are unitary. Nevertheless, one has a far reaching analogy with the usual commutative classical mechanics.

6.1.14 Fermionic Lagrangian formalism

The Lagrangian formalism in the bosonic case involves the commutative algebra of functions on the space-time (the “off-shell formalism”). In the literature one can also find its fermionic analog. The fermionic Lagrangian formalism involves the *Grassmann algebra* generated by *anticommuting* functions on space-time. This algebra is generated by anticommuting fields $\mathbb{R}^{1,3} \ni x \mapsto \psi(x), \psi^*(x)$. (Thus, the anticommutators of the off-shell $\psi(x), \psi^*(y)$ are always zero, unlike in the on-shell formalism).

Note that every Grassmann algebra, besides multiplication, is equipped with the *integral* (called sometimes the *Berezin integral*), the *left* and the *right derivative*. We will use the left derivative as the standard one (see eg. [15]).

The *Lagrangian density* is an even element of this Grassmann algebra:

$$\mathcal{L}(x) = -\frac{1}{2} \left(\tilde{\psi}(x) \gamma^\mu (-i\partial_\mu) \psi(x) + i\partial_\mu \tilde{\psi}(x) \gamma^\mu \psi(x) \right) - m\tilde{\psi}(x)\psi(x),$$

where as usual $\tilde{\psi}(x) = \beta\psi^*(x)$. The Euler-Lagrange equations

$$\partial_{\tilde{\psi}} \mathcal{L} - \partial_\mu \frac{\partial \mathcal{L}}{\partial \tilde{\psi}_{,\mu}} = 0, \quad \partial_\psi \mathcal{L} - \partial_\mu \frac{\partial \mathcal{L}}{\partial \psi_{,\mu}} = 0 \quad (6.23)$$

yield the Dirac equation.

One can define the *stress-energy tensor*

$$\begin{aligned} \mathcal{T}^{\mu\nu}(x) &:= -\frac{\partial \mathcal{L}(x)}{\partial \psi_{,\mu}(x)} \partial^\nu \psi(x) - \frac{\partial \mathcal{L}(x)}{\partial \tilde{\psi}_{,\mu}(x)} \partial^\nu \tilde{\psi}(x) + g^{\mu\nu} \mathcal{L}(x) \\ &= \frac{1}{2} \left(\tilde{\psi}(x) \gamma^\mu (-i\partial^\nu) \psi(x) + i\partial^\nu \tilde{\psi}(x) \gamma^\mu \psi(x) \right) \\ &\quad - g^{\mu\nu} \left(\frac{1}{2} (\tilde{\psi}(x) \gamma (-i\partial) \psi(x) + i\partial \tilde{\psi}(x) \gamma \psi(x)) + m\tilde{\psi}(x)\psi(x) \right). \end{aligned}$$

It is conserved on shell

$$\partial^\mu \mathcal{T}_{\mu\nu}(x) = 0.$$

The components of the stress-energy tensor with the first temporal coordinate are called the *Hamiltonian density* and *momentum density*.

$$\begin{aligned} \mathcal{H}(x) &:= \mathcal{T}^{00}(x) \\ &= \frac{1}{2} (\psi^*(x) \bar{\alpha} (-i\vec{\partial}) \psi(x) + i\vec{\partial} \psi^*(x) \bar{\alpha} \psi(x)) + m\psi^*(x)\beta\psi(x), \\ \mathcal{P}^i(x) &:= \mathcal{T}^{0i}(x) \\ &= -\frac{1}{2} (\psi^*(x) (-i\partial^i) \psi(x) + i\partial^i \psi^*(x) \psi(x)). \end{aligned}$$

Note that in (6.24) and (6.24) we put ψ^* on the left and ψ on the right. This is the Wick ordering for the Dirac sea quantization, which can be called the *charge Wick ordering*. The *Hamiltonian and momentum* defined from these densities coincide with the operators defined by the Dirac sea second quantization (6.16), (6.17):

$$\begin{aligned} H &= \int \mathcal{H}(t, \vec{x}) d\vec{x}, \\ \vec{P} &= \int \vec{\mathcal{P}}(t, \vec{x}) d\vec{x}. \end{aligned}$$

6.1.15 Classical 4-current

The Lagrangian is invariant w.r.t. the $U(1)$ symmetry $\psi \mapsto e^{-i\theta}\psi$. The Noether 4-current associated to this symmetry is the *4-current*, defined as

$$\begin{aligned} \mathcal{J}^\mu(x) &:= i \left(\tilde{\psi}(x) \frac{\partial \mathcal{L}(x)}{\partial \tilde{\psi}_{,\mu}} - \frac{\partial \mathcal{L}(x)}{\partial \psi_{,\mu}} \psi(x) \right) \\ &= \tilde{\psi}(x) \gamma^\mu \psi(x). \end{aligned}$$

It is conserved on shell and self-adjoint:

$$\partial_\mu \mathcal{J}^\mu(x) = 0, \quad (6.24)$$

$$\mathcal{J}^\mu(x)^* = \mathcal{J}^\mu(x). \quad (6.25)$$

The sesquilinear form given by \mathcal{J} coincides with (6.4):

$$\begin{aligned} \bar{\zeta}_1 \mathcal{J}^\mu(x) \zeta_2 &= j^\mu(\bar{\zeta}_1, \zeta_2, x) \\ &= \overline{\zeta_1(x)} \beta \gamma^\mu \zeta_2(x), \quad \zeta_1, \zeta_2 \in \mathcal{W}_D. \end{aligned}$$

The *current* or the spatial part of 4-current can be expressed in terms of the α matrices:

$$\vec{\mathcal{J}}(x) = \psi^*(x) \vec{\alpha} \psi(x).$$

The 0th component of the 4-current is called the *charge density*

$$\mathcal{Q}(x) := \mathcal{J}^0(x) = \psi^*(x) \psi(x).$$

The *charge* is

$$\begin{aligned} Q &:= \int \mathcal{Q}(t, \vec{x}) d\vec{x} \\ &= \sum_s \int (a^*(\vec{p}, s) a(\vec{p}, s) + b(\vec{p}, s) b^*(\vec{p}, s)) d\vec{p}. \end{aligned}$$

$x \mapsto \mathcal{Q}(t, \vec{x})$ is a well defined distribution with values in operators on space $\Gamma_{\mathfrak{a}}(\mathcal{W}_{\mathbb{D}}^{\text{cpl}})$. We have the relations

$$\begin{aligned}\{\mathcal{Q}(t, \vec{x}), \psi(t, \vec{y})\} &= -\psi(t, \vec{y})\delta(\vec{x} - \vec{y}), \\ \{\mathcal{Q}(t, \vec{x}), \psi^*(t, \vec{y})\} &= \psi^*(t, \vec{y})\delta(\vec{x} - \vec{y}), \\ \{\mathcal{Q}(t, \vec{x}), \mathcal{Q}(t, \vec{y})\} &= 0,\end{aligned}\tag{6.26}$$

where the bracket coincides now with the commutator, since \mathcal{Q} is even.

For $\chi \in C_c^\infty(\mathbb{R}^3, \mathbb{R})$, let α_χ denote the *-automorphism of the algebra of operators on $\mathcal{W}_{\mathbb{D}}$ defined by

$$\alpha_\chi(\psi(0, \vec{x})) := e^{-i\chi(\vec{x})}\psi(0, \vec{x}).$$

Obviously,

$$\alpha_\chi(\psi^*(0, \vec{x})) = e^{i\chi(\vec{x})}\psi^*(0, \vec{x}).$$

α_χ is called the *gauge transformation* at time $t = 0$ corresponding to χ . Set

$$Q(\chi) = \int \chi(\vec{x})\mathcal{Q}(0, \vec{x})d\vec{x}.\tag{6.27}$$

It can be used to implement the corresponding gauge transformation:

$$\alpha_\chi(B) = e^{iQ(\chi)}Be^{-iQ(\chi)}.$$

6.1.16 Quantum 4-current

Let us try to introduce the *quantum 4-current density* as an operator valued distribution on $\Gamma_{\mathfrak{a}}(\mathcal{Z}_{\mathbb{D}}^{(+)} \oplus \mathcal{Z}_{\mathbb{D}}^{(-)})$ by the antisymmetric quantization of the classical expression

$$\mathcal{J}^\mu(x) := \frac{1}{2}(\hat{\psi}^*(x)\beta\gamma^\mu\hat{\psi}(x) - \psi(x)\bar{\beta}\bar{\gamma}^\mu\psi^*(x)).\tag{6.28}$$

(See Subsubsect. A.1.3 for the definition of antisymmetric quantization. Note that $(\beta\gamma^\mu)^* = \beta\gamma^\mu$, and hence $\bar{\beta}\bar{\gamma}^\mu$ is the transpose of $\beta\gamma^\mu$). The charge conjugation C , which we introduce later on in Subsubsect. 6.2.6, satisfies $C\Omega = \Omega$ and $C\hat{\mathcal{J}}^\mu(x)C^* = -\mathcal{J}^\mu(x)$. Therefore, $(\Omega|\mathcal{J}^\mu(x)\Omega) = 0$. Hence

$$\hat{\mathcal{J}}^\mu(x) = :\tilde{\hat{\psi}}(x)\gamma^\mu\hat{\psi}(x):.$$

Formally, we can check the quantum versions of the relations (6.24) the (6.25). We have

$$\vec{\hat{\mathcal{J}}}(x) = :\hat{\psi}^*(x)\vec{\alpha}\hat{\psi}(x):,$$

and the 0th component of the 4-current is called the *charge density*

$$\hat{\mathcal{Q}}(x) := \hat{\mathcal{J}}_0(x) = :\hat{\psi}^*(x)\hat{\psi}(x):.$$

Formally, the charge density satisfies

$$\begin{aligned} [\hat{\mathcal{Q}}(t, \vec{x}), \hat{\psi}(t, \vec{y})] &= -\hat{\psi}(t, \vec{y})\delta(\vec{x} - \vec{y}), \\ [\hat{\mathcal{Q}}(t, \vec{x}), \hat{\psi}^*(t, \vec{y})] &= \hat{\psi}^*(t, \vec{y})\delta(\vec{x} - \vec{y}), \\ [\hat{\mathcal{Q}}(t, \vec{x}), \hat{\mathcal{Q}}(t, \vec{y})] &= 0. \end{aligned} \quad (6.29)$$

For $\chi \in C_c^\infty(\mathbb{R}^3)$ let α_χ denote the gauge transformation at time $t = 0$ defined as a *-automorphism of the algebra generated by fields satisfying (5.29), and hence also (5.30). Assume that $\chi \neq 0$. Let us check whether α_χ is unitarily implementable.

On the level of annihilation operators we have

$$\begin{aligned} \alpha_\chi(\hat{a}(p)) &= \sum_{s_1} \int \int \frac{d\vec{x}d\vec{p}_1}{(2\pi)^3} \overline{u(p, s)} u(p_1, s_1) e^{i(\vec{p}_1 - \vec{p})\vec{x} - ie\chi(\vec{x})} \hat{a}(p_1) \\ &+ \sum_{s_1} \int \int \frac{d\vec{x}d\vec{p}_1}{(2\pi)^3} \overline{u(p, s)} u(-p_1, -s_1) e^{-i(\vec{p}_1 + \vec{p})\vec{x} - ie\chi(\vec{x})} \hat{b}^*(p_1). \end{aligned}$$

Let $q_\chi(\vec{p}, s; \vec{p}_1, s_1)$ denote the integral kernel on the second line above. We need to check whether it is square integrable. Now

$$\sum_{s, s_1} |\overline{u(p, s)} u(-p_1, -s_1)|^2 = \frac{|\vec{p} + \vec{p}_1|^2 + (E(\vec{p}) - E(\vec{p}_1))^2}{2E(\vec{p})E(\vec{p}_1)}. \quad (6.30)$$

After integrating in \vec{x} we obtain fast decay in $\vec{p} + \vec{p}_1$, which allows us to control the numerator of (6.30). We obtain

$$\int |q_\chi(\vec{p}, \vec{p}_1)|^2 d\vec{p} \sim \frac{C}{E(\vec{p}_1)^2},$$

which is not integrable. Therefore, α_χ is not implementable by the *Shale-Stinespring criterion*, see Thm A.2.

Formally, with

$$\hat{Q}(\chi) := \int \chi(\vec{x}) \hat{\mathcal{Q}}(0, \vec{x}) d\vec{x}, \quad (6.31)$$

$e^{ie\hat{Q}(\chi)}$ implements the gauge transformation:

$$\alpha_\chi(B) = e^{ie\hat{Q}(\chi)} B e^{-ie\hat{Q}(\chi)}.$$

But we know that nontrivial gauge transformations are not implementable. Thus for nonzero χ (6.31) cannot be defined as a closable operator.

However, the (quantum) charge

$$\hat{Q} := \int \hat{\mathcal{Q}}(t, \vec{x}) d\vec{x} \quad (6.32)$$

is a well defined self-adjoint operator, which we already discussed before.

For further reference let us express the charge density in terms of creation and annihilation operators:

$$\begin{aligned}
\hat{Q}(x) &= \int \int \frac{d\vec{p}_1 d\vec{p}_2}{(2\pi)^3} \overline{u(p_1, s_1)} u(p_2, s_2) e^{-ixp_1 + ixp_2} \hat{a}^*(p_1, s_1) \hat{a}(p_2, s_2) \\
&\quad - \int \int \frac{d\vec{p}_1 d\vec{p}_2}{(2\pi)^3} \overline{u(-p_1, -s_1)} u(-p_2, -s_2) e^{ixp_1 - ixp_2} \hat{b}^*(p_2, s_2) \hat{b}(p_1, s_1) \\
&\quad + \int \int \frac{d\vec{p}_1 d\vec{p}_2}{(2\pi)^3} \overline{u(p_1, s_1)} u(-p_2, -s_2) e^{-ixp_1 - ixp_2} \hat{a}^*(p_1, s_1) \hat{b}^*(p_2, s_2) \\
&\quad + \int \int \frac{d\vec{p}_1 d\vec{p}_2}{(2\pi)^3} \overline{u(-p_1, -s_1)} u(p_2, s_2) e^{ixp_1 + ixp_2} \hat{b}(p_1, s_1) \hat{a}(p_2, s_2).
\end{aligned}$$

To obtain $\vec{\mathcal{J}}(x)$ one inserts \vec{a} between $\overline{u(\cdot, \cdot)}$ and $u(\cdot, \cdot)$.

6.2 Dirac fermions in an external 4-potential

6.2.1 Dirac equation in an external 4-potential

Let

$$\mathbb{R}^{1,3} \ni x \mapsto A(x) = [A_\mu(x)] \in \mathbb{R}^{1,3} \quad (6.33)$$

be a given function. In most of this subsection we assume that (6.33) is Schwartz. The Dirac equation in an *external 4-potential* A is

$$(\gamma^\mu (-i\partial_\mu + eA_\mu(x)) + m)\psi(x) = 0. \quad (6.34)$$

If ψ satisfies (6.34) and $\mathbb{R}^{1,3} \ni x \mapsto \chi(x) \in \mathbb{R}$ is an arbitrary smooth function, then $e^{ie\chi}\psi$ satisfies (6.34) with A replaced with $A + \partial\chi$.

Note the identity

$$\begin{aligned}
& -(\gamma^\mu (-i\partial_\mu + eA_\mu(x)) + m)(\gamma^\mu (-i\partial_\mu + eA_\mu(x)) - m) \\
&= -(\partial_\mu + ieA_\mu(x))(\partial^\mu + ieA^\mu(x)) + m^2 + \frac{e}{2}\sigma^{\mu\nu}F_{\mu\nu}(x). \quad (6.35)
\end{aligned}$$

Let $D^\pm(x, y)$ denote the retarded/advanced Green's function of (6.35). Then

$$S^\pm(x, y) := (\gamma^\mu (-i\partial_{x^\mu} + eA_\mu(x)) - m)D(x, y)$$

is the retarded/advanced Green's function of (6.34), that is, the unique solution of

$$(\gamma^\mu (-i\partial_\mu + eA_\mu(x)) + m)S^\pm(x, y) = \delta(x - y) \quad (6.36)$$

satisfying

$$\text{supp}S^\pm \subset \{x, y : x \in J^\pm(y)\}.$$

We set

$$S(x, y) := S^+(x, y) - S^-(x, y).$$

Clearly,

$$\text{supp}S \subset \{x, y : x \in J(y)\}.$$

We would like to introduce a field $\mathbb{R}^{1,3} \ni x \mapsto \psi(x)$ satisfying (6.34). If we assume that it acts on \mathcal{W}_D and coincides with the free field $\psi_{\text{fr}}(x)$ at $x^0 = 0$, such a field is given by

$$\psi(t, \vec{x}) = -i \int_{\mathbb{R}^3} S(t, \vec{x}; 0, \vec{y}) \beta \psi_{\text{fr}}(0, \vec{y}) d\vec{y}. \quad (6.37)$$

6.2.2 Lagrangian and Hamiltonian formalism

(6.34) can be obtained as the Euler-Lagrange of a variational problem. The *Lagrangian density* can be taken as

$$\begin{aligned} \mathcal{L}(x) &= -\frac{1}{2} \left(\tilde{\psi}(x) \gamma^\mu (-i\partial_\mu) \psi(x) + i\partial_\mu \tilde{\psi}(x) \gamma^\mu \psi(x) \right) \\ &\quad - \tilde{\psi}(x) e A_\mu(x) \gamma^\mu \psi(x) - m \tilde{\psi}(x) \psi(x). \end{aligned}$$

The Euler-Lagrange equations (6.23) yield (6.34).

We can introduce the *Hamiltonian density*

$$\begin{aligned} \mathcal{H}(x) &= \dot{\psi}(x) \frac{\partial \mathcal{L}(x)}{\partial \dot{\psi}(x)} + \dot{\psi}^*(x) \frac{\partial \mathcal{L}(x)}{\partial \dot{\psi}^*(x)} - \mathcal{L}(x) \\ &= \frac{1}{2} \left(\psi^*(x) \vec{\alpha} (-i\vec{\partial}) \psi(x) + i\vec{\partial} \psi^*(x) \vec{\alpha} \psi(x) \right) \\ &\quad + \psi^*(x) (e \vec{\gamma} \vec{A}(x) + m\beta + eA_0(x)) \psi(x). \end{aligned}$$

The *Hamiltonian*

$$H(t) = \int \mathcal{H}(t, \vec{x}) d\vec{x}$$

can be interpreted as a self-adjoint operator on $\Gamma_{\text{a}}(\mathcal{W}_D^{\text{cp1}})$ that generates the “classical” dynamics

$$\dot{\psi}(t, \vec{x}) = i\{H(t), \psi(t, \vec{x})\},$$

where now $\{\cdot, \cdot\}$ has the meaning of the commutator.

6.2.3 Classical discrete symmetries

Let κ be a unitary 4×4 matrix satisfying

$$\kappa \bar{\kappa} = \mathbb{1}, \quad \kappa \gamma^\mu \kappa^{-1} = -\bar{\gamma}^\mu,$$

where the bar denotes the complex conjugation. In particular, $\kappa \beta \kappa^{-1} = -\bar{\beta}$. Note also that

$$\kappa \bar{\kappa} \bar{u} = u, \quad u \in \mathbb{C}^4.$$

Choose $\xi_C \in \mathbb{C}$, $|\xi_C| = 1$. If ζ solves the Dirac equation with the 4-potential A , then so does $\xi_C \kappa \zeta$ with the 4-potential $-A$. Thus replacing

$$\begin{aligned} &\psi(x), \psi^*(x), A(x) \\ \text{with } &\bar{\xi}_C \kappa \psi^*(x), \xi_C \bar{\kappa} \psi(x), -A(x) \end{aligned}$$

is a symmetry of the Dirac equation with external 4-potentials (6.34). It is called *charge conjugation* and denoted \mathcal{C} .

The matrix κ depends on a representation. In the Majorana representation it is the identity. In the Dirac and spinor representation it can be chosen to be γ^2 multiplied by an arbitrary phase factor. In fact, in these representations $\bar{\gamma}^\mu = \gamma^\mu$, except for $\mu = 2$ satisfying $\bar{\gamma}^2 = -\gamma^2$. When we consider the Dirac representation, we will adopt the convention

$$\kappa := i\gamma^2.$$

Then $\bar{\kappa} = \kappa = \kappa^*$. The spinor basis that we chose in (6.5) is compatible with κ :

$$\overline{\kappa u(p, s)} = u(-p, -s). \quad (6.38)$$

Choose $\xi_P \in \{1, -1\}$. Recall that P denotes the space inversion. Replacing

$$\begin{aligned} & \psi(x), \psi^*(x), (A_0(x), \vec{A}(x)) \\ \text{with } & \xi_P \gamma^0 \psi(Px), \xi_P \gamma^0 \psi^*(Px), (A_0(Px), -\vec{A}(Px)) \end{aligned}$$

is a symmetry of (6.34) called *parity* and denoted \mathcal{P} .

Choose $\xi_T \in \mathbb{C}$, $|\xi_T| = 1$. Recall that T denotes the time reflection. Replacing (in the Dirac representation)

$$\begin{aligned} & \psi(x), \psi^*(x), (A_0(x), \vec{A}(x)) \\ \text{with } & \bar{\xi}_T \gamma^1 \gamma^3 \psi^*(Tx), \xi_T \gamma^1 \gamma^3 \psi(Tx), (A_0(Tx), -\vec{A}(Tx)) \end{aligned}$$

is a symmetry of (6.34) called *time reversal* and denoted \mathcal{T} .

The symmetry that is guaranteed by the CPT Theorem consists in replacing

$$\begin{aligned} & \psi(x), \psi^*(x), A(x) \\ \text{with } & i\gamma^5 \psi(-x), -i\gamma^5 \psi^*(-x), -A(-x). \end{aligned}$$

It is denoted \mathcal{X} . (Note that $i\gamma^5 = \gamma^0 \gamma^1 \gamma^2 \gamma^3$).

Assume that $\bar{\xi}_C \xi_P \xi_T = i$. Then

$$\mathcal{X} = \mathcal{CPT}$$

and we have the relations

$$\begin{aligned} \mathcal{C}^2 &= \mathcal{P}^2 = -\mathcal{T}^2 = -\mathcal{X}^2 = \text{id}, \\ \mathcal{CP} + \mathcal{PC} &= \mathcal{CT} + \mathcal{TC} = 0, \\ \mathcal{XP} + \mathcal{PX} &= \mathcal{XT} + \mathcal{TX} = 0, \\ \mathcal{CX} - \mathcal{XC} &= \mathcal{PT} - \mathcal{TP} = 0. \end{aligned}$$

To understand better these relations, let us notice that the automorphisms \mathcal{P} , \mathcal{CT} and \mathcal{X} anticommute and

$$\mathcal{P}^2 = (\mathcal{CT})^2 = -\mathcal{X}^2 = \text{id},$$

where id denotes the identity. Thus together with $Spin^\uparrow(1, 3)$ they represent the group $Pin_+(1, 3)$, see Subsubsection. 1.1.5.

Besides,

$$(\mathcal{PT})^2 = -\text{id}$$

and \mathcal{PT} commutes with \mathcal{P} , \mathcal{CT} , \mathcal{X} . Thus it behaves as $i \cdot \text{id}$. Thus the group generated by $Spin^\uparrow(1, 3)$, \mathcal{C} , \mathcal{P} and \mathcal{T} is $Pin_{\text{ext}}(1, 3)$, see Subsubsection. 1.1.6.

6.2.4 Quantization

We are looking for a quantum field satisfying

$$(\gamma^\mu(-i\partial_\mu + eA_\mu(x)) + m)\hat{\psi}(x) = 0 \quad (6.39)$$

such that

$$\hat{\psi}(\vec{x}) := \hat{\psi}(0, \vec{x}) = \hat{\psi}_{\text{fr}}(0, \vec{x}).$$

Clearly the solution is obtained by decorating (6.37) with hats.

As in the bosonic case, we ask whether the fields are implemented by a unitary dynamics. Equivalently, we want to check if the classical dynamics generated by $H_{\text{Int}}(t)$ satisfies the Shale-Stinespring criterion.

Arguments parallel to those of Subsubsection. 2.3.4 show that the classical scattering operator is unitarily implementable.

An analysis similar to that of Subsect. 5.2.4 shows that the dynamics from t_- to t_+ is implementable on the Fock space iff the spatial part of the 4-potential is the same at the initial and final time:

$$\vec{A}(t_+, \vec{x}) = \vec{A}(t_-, \vec{x}), \quad \vec{x} \in \mathbb{R}^3. \quad (6.40)$$

6.2.5 Quantum Hamiltonian

Formally, we can also obtain the quantum field from a unitary dynamics:

$$\hat{\psi}(t, \vec{x}) := \text{Texp} \left(-i \int_t^0 \hat{H}(s) ds \right) \hat{\psi}(0, \vec{x}) \text{Texp} \left(-i \int_0^t \hat{H}(s) ds \right),$$

where the Schrödinger picture Hamiltonian $\hat{H}(t)$ and the corresponding interaction picture Hamiltonian are

$$\begin{aligned} \hat{H}(t) &= \int d\vec{x}: (\hat{\psi}^*(\vec{x})(\vec{\alpha}(-i\vec{\partial} + e\vec{A}(t, \vec{x})) + m\beta + eA_0(t, \vec{x}))\hat{\psi}(\vec{x})), \\ \hat{H}_{\text{Int}}(t) &= \int d\vec{x} e A_\mu(t, \vec{x}) \hat{J}_{\text{fr}}^\mu(t, \vec{x}). \end{aligned}$$

Note that unlike in the case of charged bosons we use the Wick ordering. This is because $\hat{H}(t)$ differs from \hat{H}_{fr} by a term involving the 4-current $\hat{J}_{\text{fr}}^\mu(t, \vec{x})$, which is automatically Wick ordered. Therefore, we can assume that both $\hat{H}(t)$ and \hat{H}_{fr} are Wick ordered, which was impossible for charged bosons.

6.2.6 Quantized discrete symmetries

The discrete symmetries considered in Subsubsect. 6.2.3 remain true when we decorate the fields with “hats”. Thus on the level of quantum observables the discrete symmetries are the same as in the classical case.

Let us now discuss the implementation of these symmetries by unitary or antiunitary operators on the Hilbert space $\Gamma_a(\mathcal{Z}_D^{(+)} \oplus \mathcal{Z}_D^{(-)})$. We will discuss this for free fields, that is, for $A = 0$. As in the bosonic case, this will imply some properties of the scattering operator $\hat{S}(A)$.

First consider the charge conjugation. We define the following unitary operator on $\mathcal{Z}_D^{(+)} \oplus \mathcal{Z}_D^{(-)}$

$$\chi(g_1, \bar{g}_2) := (\xi_C \bar{\kappa} g_2, \bar{\xi}_C \kappa \bar{g}_1).$$

We check that

$$\chi|p, s) = \xi_C \overline{|-p, -s)}, \quad \overline{\chi|-p, -s)} = \bar{\xi}_C |p, s).$$

We set $C := \Gamma(\chi)$. We have $C^2 = \mathbb{1}$,

$$\begin{aligned} C \hat{\psi}_{\text{fr}}(x) C^{-1} &= \bar{\xi}_C \kappa \hat{\psi}_{\text{fr}}^*(x), & C \hat{\psi}_{\text{fr}}^*(x) C^{-1} &= \xi_C \bar{\kappa} \hat{\psi}_{\text{fr}}(x), \\ C \hat{\mathcal{Q}}_{\text{fr}}(x) C^{-1} &= -\hat{\mathcal{Q}}_{\text{fr}}(x), & C \vec{\mathcal{J}}_{\text{fr}}(x) C^{-1} &= -\vec{\mathcal{J}}_{\text{fr}}(x), \\ C \hat{S}(A) C^{-1} &= \hat{S}(-A). \end{aligned}$$

Define the following unitary operator on $\mathcal{Z}_D^{(+)} \oplus \mathcal{Z}_D^{(-)}$:

$$\pi(g_1, \bar{g}_2) := (\xi_P \gamma^0 g_1 \circ P, \xi_P \gamma^0 \bar{g}_2 \circ P).$$

We check that

$$\pi|E, \vec{p}, s) = \xi_P |E, -\vec{p}, s), \quad \pi|-E, -\vec{p}, s) = \xi_P |-E, \vec{p}, s).$$

Set $P := \Gamma(\pi)$. We have $P^2 = \mathbb{1}$,

$$\begin{aligned} P \hat{\psi}_{\text{fr}}(x) P^{-1} &= \xi_P \gamma^0 \hat{\psi}_{\text{fr}}(Px), & P \hat{\psi}_{\text{fr}}^*(x) P^{-1} &= \xi_P \gamma^0 \hat{\psi}_{\text{fr}}^*(Px), \\ P \hat{\mathcal{Q}}_{\text{fr}}(x) P^{-1} &= \hat{\mathcal{Q}}_{\text{fr}}(Px), & P \vec{\mathcal{J}}_{\text{fr}}(x) P^{-1} &= -\vec{\mathcal{J}}_{\text{fr}}(Px), \\ P \hat{S}(A_0, \vec{A}) P^{-1} &= \hat{S}(A_0 \circ P, -\vec{A} \circ P). \end{aligned}$$

Define (in the Dirac representation) the following antiunitary operator on $\mathcal{Z}_D^{(+)} \oplus \mathcal{Z}_D^{(-)}$:

$$\tau(g_1, \bar{g}_2) := (\xi_T \gamma^1 \gamma^3 \bar{g}_1 \circ T, \bar{\xi}_T \gamma^1 \gamma^3 g_2 \circ T).$$

We check that

$$\tau|E, \vec{p}, s) = \xi_T |E, -\vec{p}, -s), \quad \tau|-E, -\vec{p}, s) = \bar{\xi}_T |-E, \vec{p}, -s).$$

Set $T := \Gamma(\tau)$. We have $T^2 = -\mathbb{1}$,

$$\begin{aligned} T \hat{\psi}_{\text{fr}}(x) T^{-1} &= \bar{\xi}_T \gamma^1 \gamma^3 \hat{\psi}_{\text{fr}}^*(Tx), & T \hat{\psi}_{\text{fr}}^*(x) T^{-1} &= \xi_T \gamma^1 \gamma^3 \hat{\psi}_{\text{fr}}(Tx), \\ T \hat{\mathcal{Q}}_{\text{fr}}(x) T^{-1} &= \hat{\mathcal{Q}}_{\text{fr}}(Tx), & T \vec{\mathcal{J}}_{\text{fr}}(x) T^{-1} &= -\vec{\mathcal{J}}_{\text{fr}}(Tx), \\ T \hat{S}(A_0, \vec{A}) T^{-1} &= \hat{S}(A_0 \circ T, -\vec{A} \circ T). \end{aligned}$$

6.2.7 $2N$ -point Green's functions

We consider again a Dirac field in an external 4-potential $[A^\mu(x)]$. For $y_N, \dots, y_1, x_N, \dots, x_1$, the $2N$ point Green's function are defined as follows:

$$\begin{aligned} & \langle \tilde{\psi}(y_1) \cdots \tilde{\psi}(y_N) \hat{\psi}(x_N) \cdots \hat{\psi}(x_1) \rangle \\ & := \left(\Omega^+ | \Gamma \left(\tilde{\psi}(y_1) \cdots \tilde{\psi}(y_N) \hat{\psi}(x_N) \cdots \hat{\psi}(x_1) \right) \Omega^- \right). \end{aligned}$$

One can organize Green's functions in terms of the *generating function*:

$$\begin{aligned} & Z(g, \tilde{g}) \\ & := \sum_{n=0}^{\infty} \int \cdots \int \frac{(-1)^N}{(N!)^2} \langle \tilde{\psi}(y_1) \cdots \tilde{\psi}(y_N) \hat{\psi}(x_N) \cdots \hat{\psi}(x_1) \rangle \\ & \quad \times g(y_1) \cdots g(y_N) \tilde{g}(x_N) \cdots \tilde{g}(x_1) dy_1 \cdots dy_N dx_N \cdots dx_1 \\ & = \left(\Omega \left| \text{Texp} \left(-i \int_{-\infty}^{\infty} \hat{H}_{\text{Int}}(t) dt - i \int g(x) \tilde{\psi}_{\text{fr}}(x) dx - i \int \tilde{g}(x) \hat{\psi}_{\text{fr}}(x) dx \right) \Omega \right. \right), \end{aligned}$$

where $\mathbb{R}^{1,3} \ni x \mapsto g(x), \tilde{g}(x) \in \mathbb{C}^4$ are Grassmann variables anticommuting with $\hat{\psi}(x), \tilde{\psi}(x)$.

One can retrieve Green's functions from the generating function:

$$\begin{aligned} & \langle \tilde{\psi}(y_1) \cdots \tilde{\psi}(y_N) \hat{\psi}(x_N) \cdots \hat{\psi}(x_1) \rangle \\ & = (-1)^N \frac{\partial^{2N}}{\partial g(y_1) \cdots \partial g(y_N) \partial \tilde{g}(x_N) \cdots \partial \tilde{g}(x_1)} Z(g, \tilde{g}) \Big|_{g=\tilde{g}=0}. \end{aligned}$$

We introduce also the *amputated Green's function*

$$\begin{aligned} & \langle \tilde{\psi}(p'_1) \cdots \tilde{\psi}(p'_N) \hat{\psi}(p_N) \cdots \hat{\psi}(p_1) \rangle_{\text{amp}} \\ & := (\gamma p'_1 + m) \cdots (\gamma p'_N + m) (\gamma p_N + m) \cdots (\gamma p_1 + m) \\ & \quad \times \langle \tilde{\psi}(p'_1) \cdots \tilde{\psi}(p'_N) \hat{\psi}(p_N) \cdots \hat{\psi}(p_1) \rangle. \end{aligned}$$

Introduce *many particle plane waves*

$$\begin{aligned} & \overline{|-p'_{N'}, -s'_{N'}; \dots; -p'_1, -s'_1; p_N, s_N; \dots; p_1, s_1)} \\ & := \hat{b}^*(p'_{N'}, s'_{N'}) \cdots \hat{b}^*(p'_1, s'_1) \hat{a}^*(p_N, s_N) \cdots \hat{a}^*(p_1, s_1) \Omega, \end{aligned}$$

where all p_i, p'_i are on shell. *Scattering amplitudes* are the matrix elements of the scattering operator \hat{S} between plane waves. One can compute scattering amplitudes from the amputated Green's functions:

$$\begin{aligned} & \left(\overline{|-p_{n^+}', -s_{n^+}' ; \dots; p_{n^+}^+, s_{n^+}^+ ; \dots} | \hat{S} | \overline{|-p_{n^-}', -s_{n^-}' ; \dots; p_{n^-}^-, s_{n^-}^- ; \dots} \right) \\ & = \frac{\cdots \tilde{u}(p_{n^+}^+, s_{n^+}^+) \cdots u(-p_{n^+}'^-, -s_{n^+}'^-) \tilde{u}(-p_{n^-}'^-, -s_{n^-}'^-) \cdots u(p_{n^-}^-, s_{n^-}^-) \cdots}{\sqrt{(2\pi)^{3(n^++n^+{}'+n^-'+n^-)}}} \\ & \quad \times \langle \cdots \hat{\psi}(p_{n^+}^+) \cdots \tilde{\psi}(p_{n^+}'^+) \psi(-p_{n^-}'^-) \cdots \tilde{\psi}(-p_{n^-}^-) \cdots \rangle_{\text{amp}}. \end{aligned}$$

The scattering operator and Green's functions satisfy the Ward identities analogous to those satisfied by charged bosons.

6.2.8 Path integral formulation

We have the following formula for the generating function:

$$\begin{aligned}
& Z(g, \tilde{g}) \tag{6.41} \\
&= \det(\gamma^\mu(-i\partial_\mu + eA_\mu(x)) + m)(-i\gamma^\mu\partial_\mu + m - i\epsilon)^{-1} \\
&\quad \times \exp\left(i\tilde{g}(\gamma^\mu(-i\partial_\mu + eA_\mu(x)) + m - i\epsilon)^{-1}g\right) \\
&= \det(\mathbb{1} + \gamma_\mu eA^\mu S_{\text{fr}}^c) \\
&\quad \times \exp\left(i\tilde{g}S_{\text{fr}}^c(\mathbb{1} + \gamma_\mu eA^\mu S_{\text{fr}}^c)^{-1}g\right),
\end{aligned}$$

where ϵ has the same meaning as in (6.2).

In terms of path integrals this can be formally written as

$$\frac{\int \prod_y d\tilde{\psi}(x) \prod_{y'} d\psi(y) \exp\left(i \int (\mathcal{L}(x) - g(x)\tilde{\psi}(x) - \tilde{g}(x)\psi(x)) dx\right)}{\int \prod_y d\tilde{\psi}(y) \prod_{y'} d\psi(y') \exp\left(i \int \mathcal{L}_{\text{fr}}(x) dx\right)}.$$

6.2.9 Feynman rules

The Feynman rules are very similar to those for charged bosons, except that there are no two-photon vertices. Here are the Feynman rules for Green's functions.

- (1) In the n th order we draw all possible topologically distinct Feynman diagrams with n vertices and external lines. All the charged lines have a natural arrow.
- (2) To each vertex we associate the factor $-ie\gamma^\mu A_\mu(p^+ - p^-)$.
- (3) To each line we associate the propagator $-iS_{\text{fr}}^c(p) = -i\frac{-p\gamma + m}{p^2 + m^2 - i0}$.
- (4) For internal lines we integrate over the variables with the measure $\frac{d^4p}{(2\pi)^4}$.
- (5) If two diagrams differ only by an exchange of two fermionic lines, there is an additional factor (-1) for one of them. This implies, in particular, that loops have an additional factor (-1) .

To compute scattering amplitudes with N^- incoming and N^+ outgoing particles we draw the same diagrams as for $N^- + N^+$ -point Green's functions. The rules are changed only concerning the external lines.

- (i) With each incoming external line we associate

- fermion: $\frac{1}{\sqrt{(2\pi)^3}} u(p, s)$.

- anti-fermion: $\frac{1}{\sqrt{(2\pi)^3}} \tilde{u}(-p, -s)$.

(ii) With each outgoing external line we associate

- fermion: $\frac{1}{\sqrt{(2\pi)^3}} \tilde{u}(p, s)$.
- anti-fermion: $\frac{1}{\sqrt{(2\pi)^3}} u(-p, -s)$.

Each incoming and outgoing antifermion has an additional factor (-1) . (This follows from the rule (5) above).

6.2.10 Vacuum energy

Formally, the vacuum energy can be computed exactly:

$$\begin{aligned}
\mathcal{E} &:= i \log(\Omega | \hat{S} \Omega) = i \log Z(0, 0) \\
&= i \text{Tr} \left(\log(\gamma^\mu (-i\partial_\mu + eA_\mu(x)) + m - i\epsilon) - \log(-i\gamma^\mu \partial_\mu + m - i\epsilon) \right) \\
&= i \text{Tr} \log(\mathbb{1} + \gamma^\mu eA_\mu S_{\text{fr}}^c) \\
&= i \sum_{n=1}^{\infty} \frac{D_n}{n}. \tag{6.42}
\end{aligned}$$

Here D_n is the value of the loop with n vertices. Note that n in the denominator is the order of the group of the automorphisms of a loop with n vertices, which is \mathbb{Z}_n .

Furry's theorem, proven as in the bosonic case, says that diagrams for charged fermions of the odd order in e vanish. Hence (6.42) can be written as

$$\mathcal{E} = \sum_{n=1}^{\infty} e^{2n} \mathcal{E}_n,$$

where $e^{2n} \mathcal{E}_n = i \frac{D_{2n}}{2n}$.

Just as in the bosonic case, the expressions for \mathcal{E}_n obtained from the Feynman rules are convergent for $n \geq 3$. The gauge invariant part of \mathcal{E}_2 is convergent. The computation of \mathcal{E}_1 will be described below – it needs an infinite renormalization.

There exists a close relationship between the fermionic and bosonic vacuum energy. To see it, note that using $\gamma^5 \gamma_\mu (\gamma^5)^{-1} = -\gamma_\mu$, we obtain

$$\begin{aligned}
\mathcal{E} &= i \text{Tr} \left(\log(-\gamma^\mu (-i\partial_\mu + eA_\mu(x)) + m - i\epsilon) \right. \\
&\quad \left. - \log(i\gamma^\mu \partial_\mu + m - i\epsilon) \right). \tag{6.43}
\end{aligned}$$

We add up $\frac{1}{2}(6.42)$ and $\frac{1}{2}(6.43)$ and use identity (6.35). We obtain

$$\begin{aligned}
\mathcal{E} &= \frac{i}{2} \text{Tr} \left(-\log \left(-(\partial_\mu + ieA_\mu(x))(\partial^\mu + ieA^\mu(x)) + m^2 + \frac{e}{2} \sigma^{\mu\nu} F_{\mu\nu}(x) - i0 \right) \right. \\
&\quad \left. + \log \left(-\square + m^2 - i0 \right) \right) \\
&= \frac{i}{2} \text{Tr} \log \left(\mathbb{1} + \left(ie\partial_\mu A^\mu(x) + ieA^\mu(x)\partial_\mu + e^2 A_\mu(x)A^\mu(x) \right. \right. \\
&\quad \left. \left. + \frac{e}{2} \sigma^{\mu\nu} F_{\mu\nu}(x) \right) D_{\text{fr}}^e \right). \tag{6.44}
\end{aligned}$$

We can compare (6.44) with a similar expression in the bosonic case (5.46).

6.2.11 Pauli-Villars renormalization

A single electron loop with two vertices coming from a 4-potential A^μ leads to a contribution of the form

$$\mathcal{E}_1 = \int \frac{d^4 p}{(2\pi)^4} A^\mu(-p) A^\nu(p) \Pi_{\mu\nu}(p).$$

Unfortunately, computed naively, $\Pi_{\mu\nu}(p)$ is divergent.

We will compute it using the Pauli-Villars regularization, similarly as for charged bosons, see Subsubsection. 5.2.11:

$$\begin{aligned}
2\Pi_{\mu\nu\Lambda}(p) &= -\sum_i C_i i e^2 \int \frac{d^4 q}{(2\pi)^4} \frac{\text{Tr} \gamma_\mu \left((q + \frac{1}{2}p) \gamma + m_i \right) \gamma_\nu \left((q - \frac{1}{2}p) \gamma + m_i \right)}{\left((q + \frac{1}{2}p)^2 + m_i^2 - i0 \right) \left((q - \frac{1}{2}p)^2 + m_i^2 - i0 \right)} \\
&= -\sum_i C_i i e^2 \int \frac{4d^4 q}{(2\pi)^4} \frac{2q_\mu q_\nu - \frac{1}{2} p_\mu p_\nu - g_{\mu\nu} (q^2 - \frac{1}{4} p^2 + m_i^2)}{\left((q + \frac{1}{2}p)^2 + m_i^2 - i0 \right) \left((q - \frac{1}{2}p)^2 + m_i^2 - i0 \right)} \\
&= \sum_i C_i \frac{e^2}{(4\pi)^2} \int_0^\infty d\alpha_1 \int_0^\infty d\alpha_2 \left(\frac{8\alpha_1 \alpha_2}{(\alpha_1 + \alpha_2)^4} (p_\mu p_\nu - g_{\mu\nu} p^2) \right. \\
&\quad \left. + 4g_{\mu\nu} \left(\frac{\alpha_1 \alpha_2}{(\alpha_1 + \alpha_2)^4} p^2 + \frac{i}{(\alpha_1 + \alpha_2)^3} + \frac{m_i^2}{(\alpha_1 + \alpha_2)^2} \right) \right) \\
&\quad \times \exp \left(-i(\alpha_1 + \alpha_2) m_i^2 - i \frac{\alpha_1 \alpha_2}{\alpha_1 + \alpha_2} p^2 \right) \\
&=: (-g_{\mu\nu} p^2 + p_\mu p_\nu) 2\Pi_\Lambda^{\text{gi}}(p^2) + 2\Pi_{\mu\nu\Lambda}^{\text{gd}}(p).
\end{aligned}$$

We used the identity (A.23).

The gauge dependent part of the vacuum energy tensor up to a coefficient is the same as for charged bosons and vanishes. We apply the same substitutions

and use the same identities as in the charged boson case:

$$\begin{aligned}
\Pi_{\Lambda}^{\text{gi}}(p^2) &= -\frac{e^2}{(4\pi)^2} \sum_i C_i \int_0^\infty d\alpha_1 \int_0^\infty d\alpha_2 \frac{4\alpha_1\alpha_2}{(\alpha_1 + \alpha_2)^4} \\
&\quad \times \exp\left(-i(\alpha_1 + \alpha_2)m_i^2 - i\frac{\alpha_1\alpha_2}{\alpha_1 + \alpha_2}p^2\right) \\
&= -\frac{e^2}{(4\pi)^2} \sum_i C_i \int_0^1 dv \int_0^\infty \frac{d\rho}{\rho} (1-v^2) \\
&\quad \times \exp\left(-i\rho\left(m_i^2 + \frac{(1-v^2)p^2}{4}\right)\right) \\
&= \frac{e^2}{(4\pi)^2} \sum_i C_i \int_0^1 dv (1-v^2) \log\left(m_i^2 + \frac{(1-v^2)p^2}{4} - i0\right) \\
&= \frac{e^2}{(4\pi)^2} \sum_i C_i \left(\int_0^1 dv (1-v^2) \log\left(1 + \frac{(1-v^2)p^2}{4m_i^2} - i0\right) + \frac{1}{3} \log m_i^2\right).
\end{aligned}$$

Define

$$\begin{aligned}
\Pi^{\text{ren}}(p^2) &:= \lim_{\Lambda \rightarrow \infty} (\Pi_{\Lambda}^{\text{gi}}(p^2) - \Pi_{\Lambda}^{\text{gi}}(0)) \\
&= \frac{e^2}{(4\pi)^2} \int_0^1 dv (1-v^2) \log\left(1 + \frac{(1-v^2)p^2}{4m^2} - i0\right).
\end{aligned} \tag{6.45}$$

Denote the vacuum energy function for neutral bosons, introduced in (2.114), by $\pi_{\text{b}}^{\text{ren}}$. Let $\Pi_{\text{b}}^{\text{ren}}$ denote the vacuum energy function for charged bosons (5.49) and $\Pi_{\text{f}}^{\text{ren}}$ for charged fermions (6.45). Let us note the following identity:

$$2\Pi_{\text{b}}^{\text{ren}}(p^2) + \Pi_{\text{f}}^{\text{ren}}(p^2) = 4e^2\pi^{\text{ren}}(p^2). \tag{6.46}$$

This identity can be also derived from (6.44), (5.46) and (2.112).

6.2.12 Method of dispersion relations

The imaginary part of the gauge invariant vacuum energy function can be computed without regularization:

$$\begin{aligned}
\text{Im}\Pi^{\text{ren}}(p^2) &= \text{Im} \frac{e^2}{(4\pi)^2} \int_0^1 dv (1-v^2) \log\left(m^2 + \frac{(1-v^2)p^2}{4} - i0\right) \\
&= \frac{e^2}{(4\pi)^2} \int_0^1 dv (1-v^2) (-\pi) \theta\left(-\frac{(1-v^2)p^2}{4} - m^2\right) \\
&= -\frac{4e^2\pi}{3(4\pi)^2} \frac{(-p^2 + 2m^2)}{(-p^2)^{3/2}} \Big|_{-p^2 - 4m^2}^{\frac{1}{2}}, \quad p^2 \in \mathbb{R}.
\end{aligned}$$

The full vacuum energy tensor can be obtained by using the once subtracted dispersion relations, as in (5.55).

6.2.13 Dimensional renormalization

We can also use dimensional regularization to compute $\Pi_{\mu\nu}^{\text{ren}}$. We use the Euclidean formalism.

$$\begin{aligned}
2\Pi_{\mu\nu}^{\text{E}}(p) &= e^2 \text{Tr}\mathbb{1} \int \frac{d^4q}{(2\pi)^4} \frac{2q_\mu q_\nu - \frac{1}{2}p_\mu p_\nu - g_{\mu\nu}(q^2 - \frac{1}{4}p^2 + m^2)}{((q + \frac{1}{2}p)^2 + m^2)((q - \frac{1}{2}p)^2 + m^2)} \\
&= e^2 \text{Tr}\mathbb{1} \int_{-1}^1 dv \int \frac{d^4q}{(2\pi)^4} \frac{2q_\mu q_\nu - \frac{1}{2}p_\mu p_\nu - g_{\mu\nu}(q^2 - \frac{1}{4}p^2 + m^2)}{(q^2 + \frac{v^2}{4} + m^2 + vqp)^2} \\
&= e^2 \text{Tr}\mathbb{1} \int_0^1 dv \int \frac{d^4q}{(2\pi)^4} \\
&\quad \times \frac{2q_\mu q_\nu - \frac{1}{2}p_\mu p_\nu - g_{\mu\nu}(q^2 - \frac{1}{4}p^2 + m^2) + v^2(\frac{1}{2}p_\mu p_\nu - g_{\mu\nu}\frac{p^2}{4})}{(q^2 + \frac{v^2}{4}(1-v^2) + m^2)^2}. \tag{6.47}
\end{aligned}$$

Then we use the dimensional regularization. Besides the rules (5.58) and (5.59) we have a new rule:

$$\text{Tr}\mathbb{1} \text{ is replaced by } 2^{d/2}. \tag{6.48}$$

Thus (6.47) is replaced by

$$\begin{aligned}
\Pi_{\mu\nu}^{\text{E},d}(p) &= e^2 \frac{2^{d/2} \mu^{4-d} \Omega_d}{(2\pi)^d} \int_0^1 dv \int_0^\infty |q|^{d-1} d|q| \\
&\quad \times \frac{((2/d-1)g_{\mu\nu}q^2 - \frac{1}{2}p_\mu p_\nu - g_{\mu\nu}(-\frac{1}{4}p^2 + m^2) + v^2(\frac{1}{2}p_\mu p_\nu - g_{\mu\nu}\frac{p^2}{4}))}{(q^2 + \frac{v^2}{4}(1-v^2) + m^2)^2} \\
&= \frac{4e^2}{(4\pi)^2} \int_0^1 dv \left(\frac{\mu^2 2\pi}{\frac{v^2}{4}(1-v^2) + m^2} \right)^{2-d/2} \Gamma(2-d/2) \\
&\quad \times \left(g_{\mu\nu} \left(\frac{p^2}{4}(1-v^2) + m^2 \right) - \frac{1}{2}p_\mu p_\nu - g_{\mu\nu} \left(-\frac{1}{4}p^2 + m^2 \right) + v^2 \left(\frac{1}{2}p_\mu p_\nu - g_{\mu\nu} \frac{p^2}{4} \right) \right) \\
&= \frac{2e^2}{(4\pi)^2} \int_0^1 dv \left(\frac{\mu^2 2\pi}{\frac{v^2}{4}(1-v^2) + m^2} \right)^{2-d/2} \Gamma(2-d/2) (v^2-1) (p_\mu p_\nu - g_{\mu\nu} p^2) \\
&\simeq \frac{2e^2}{(4\pi)^2} \int_0^1 dv \left(-\gamma + \log(\mu^2 2\pi) - \log \left(\frac{p^2}{4}(1-v^2) + m^2 \right) \right) (v^2-1) (p_\mu p_\nu - g_{\mu\nu} p^2) \\
&\quad + \frac{4e^2}{3(4\pi)^2(2-d/2)} (p_\mu p_\nu - g_{\mu\nu} p^2). \tag{6.49}
\end{aligned}$$

We can now renormalize (6.49):

$$\begin{aligned}
&\Pi^{\text{E,ren}}(p^2) (p_\mu p_\nu - g_{\mu\nu} p^2) \\
&= \lim_{d \rightarrow 4} \left(\Pi_{\mu\nu}^{\text{E},d}(p^2) - \Pi_{\mu\nu}^{\text{E},d}(0) \right) \\
&= \frac{1}{(4\pi)^2} \int_0^1 dv (1-v^2) \log \left(1 + \frac{p^2}{4m^2}(1-v^2) \right) (p_\mu p_\nu - g_{\mu\nu} p^2).
\end{aligned}$$

Again, this coincides with the Wick rotated result obtained by the Pauli-Villars method.

Remark 6.3 *In the above computations we first try to eliminate gamma matrices. The only remnant of gamma matrices is $\text{tr}\mathbb{1}$, where $\mathbb{1}$ is the identity on the space of Dirac spinors, to which we apply the rule (6.48). However, we would have obtained the same final result if we used eg. the rule $\text{Tr}\mathbb{1} = 4$, since at the end we apply the normalization condition $\Pi_{\mu\nu}^{\text{ren}}(0) = 0$. We use the condition (6.48), since it is the usual choice in the literature.*

Note, however, that in more complicated situations the dimensional renormalization can be problematic, especially for fermions in the presence of γ^5 .

6.2.14 Energy shift

Suppose that the 4-potential does not depend on time and is given by a Schwartz function $\mathbb{R}^3 \ni \vec{x} \mapsto A(\vec{x}) = [A_\mu(\vec{x})]$.

The free Hamiltonian is

$$\hat{H}_{\text{fr}} = \int d\vec{x} : \hat{\psi}^*(\vec{x}) (\vec{\alpha}(-i\vec{\partial}) + m\beta) \hat{\psi}(\vec{x}) :.$$

The naive interacting Hamiltonian is

$$\hat{H} = \int d\vec{x} : \hat{\psi}^*(\vec{x}) (\vec{\alpha}(-i\vec{\partial} + e\vec{A}(\vec{x})) + m\beta + eA_0(\vec{x})) \hat{\psi}(\vec{x}) :.$$

We apply (A.19) to compute the difference between the ground state energies of \hat{H} and \hat{H}_{fr} , obtaining

$$\begin{aligned} & \text{Tr} \left(- \left| \vec{\alpha}(-i\vec{\partial} + e\vec{A}(\vec{x})) + m\beta + eA_0(\vec{x}) \right| + \left| \vec{\alpha}(-i\vec{\partial}) + m\beta \right| \right) \\ &= \sum_{n=1}^{\infty} e^{2n} E_n(A). \end{aligned} \quad (6.50)$$

Note that we could have assumed that \hat{H}_{fr} and \hat{H} are given by the antisymmetric quantization, used the formula (A.17), and we would have obtained the same result for the energy shift. Indeed, formally, the Wick and Weyl quantized versions of \hat{H}_{fr} and \hat{H} differ by the same (infinite) constant (which was not true in the bosonic case).

All the terms in (6.50) with $n \geq 2$ are well defined. The term with $n = 1$ needs renormalization. The renormalized energy shift is

$$E^{\text{ren}} = e^2 \int \Pi^{\text{ren}}(\vec{p}^2) \overline{F_{\mu\nu}(\vec{p})} F^{\mu\nu}(\vec{p}) \frac{d\vec{p}}{(2\pi)^3} + \sum_{n=2}^{\infty} e^{2n} E_n(A),$$

where Π^{ren} was introduced in (6.45).

7 Majorana fermions

In this section we consider again the *Dirac equation*

$$(-i\gamma^\mu \partial_\mu + m)\phi(x) = 0.$$

We will quantize the space of its solutions satisfying the *Majorana condition*. We obtain a formalism that describes *neutral* fermions.

In the bosonic case we first treated the neutral case and only then the charged case. In the fermionic case it is convenient to reverse the order.

7.1 Free Majorana fermions

7.1.1 Charge conjugation

Consider a representation of Dirac matrices γ^μ . Let κ be a unitary 4×4 matrix described in Subsubsection. 6.2.3. We say that $u \in \mathbb{C}^4$ is *neutral* or satisfies the *Majorana condition* if $u = \kappa \bar{u}$.

Recall that in the Majorana representation κ can be taken to be the identity. In the Dirac and spinor representation $\kappa := i\gamma_2$.

7.1.2 Space of solutions

If a function ζ satisfies the Dirac equation

$$(-i\gamma^\mu \partial_\mu + m)\zeta(x) = 0,$$

then $\kappa \bar{\zeta}$ also satisfies the Dirac equation. Therefore, we can restrict the Dirac equation to functions ζ satisfying the *Majorana condition*

$$\kappa \bar{\zeta} = \zeta. \tag{7.1}$$

The space of smooth space compact solutions of the Dirac equation satisfying (7.1) will be denoted \mathcal{Y}_D . Note that it is a real vector space equipped with a nondegenerate scalar product

$$\bar{\zeta}_1 \cdot \zeta_2 = \int \overline{\zeta_1(t, \vec{x})} \zeta_2(t, \vec{x}) d\vec{x}.$$

In the Majorana representation the space \mathcal{Y}_D consists simply of real functions. However, we will most often use the Dirac representation, where the Majorana condition is less trivial.

Let $\phi(x)$ be the linear functional on \mathcal{Y}_D defined by

$$\langle \phi(x) | \zeta \rangle = \zeta(x).$$

The complexification of \mathcal{Y}_D , that is $\mathbb{C}\mathcal{Y}_D$, can be identified with \mathcal{W}_D . We can extend $\phi(x)$ to $\mathbb{C}\mathcal{Y}_D$ by complex linearity. The subspace \mathcal{Y}_D is then determined by the condition

$$\kappa \phi^*(x) = \phi(x), \tag{7.2}$$

where $*$ is the complex conjugation as defined in (5.3).

7.1.3 Smearred fields

Smearred fields are defined very similarly as for Dirac fields. Note that in spite of the similarity of the formulas, the objects are different: they act on the real space \mathcal{Y}_D , and not on the complex space \mathcal{W}_D .

For $\zeta \in \mathcal{W}_D$, the corresponding *spatially smeared field* is the functional on \mathcal{Y}_D given by

$$\langle \phi((\zeta)) | \rho \rangle := \bar{\zeta} \cdot \rho, \quad \rho \in \mathcal{Y}_D.$$

Clearly, for any t

$$\phi((\zeta)) = \int \overline{\zeta(t, \vec{x})} \phi(t, \vec{x}) d\vec{x}.$$

For $f \in C_c^\infty(\mathbb{R}^{1,3}, \mathbb{C}^4)$ such that $\kappa \bar{f} = f$, the corresponding *space-time smeared field* is given by

$$\phi[f] := \int \overline{f(x)} \phi(x) dx = \phi((S * f)).$$

7.1.4 Plane waves

Since we consider neutral fields, the generic name for the momentum variable is again k , instead of p .

Recall that in the Dirac representation we defined the plane waves $u(k, s)$ given by (6.5). These plane waves are compatible with the Majorana condition in the following sense:

$$\overline{\kappa u(k, s)} = u(-k, -s). \quad (7.3)$$

We can introduce the plane wave functionals, where $k^0 > 0$,

$$\begin{aligned} a(k, s) &:= \phi(|k, s)) \\ &= \int \frac{d\vec{x}}{\sqrt{(2\pi)^3}} \overline{u(k, s)} e^{-i\vec{k}\vec{x}} \phi(0, \vec{x}). \end{aligned}$$

Note that

$$\begin{aligned} a^*(k, s) &:= \phi(|-k, -s)) \\ &= \int \frac{d\vec{x}}{\sqrt{(2\pi)^3}} \overline{u(-k, -s)} e^{i\vec{k}\vec{x}} \phi(0, \vec{x}). \end{aligned}$$

We have

$$\begin{aligned} \phi(x) &= \sum_s \int \frac{d\vec{k}}{\sqrt{(2\pi)^3}} (u(k, s) e^{ikx} a(k, s) + u(-k, -s) e^{-ikx} a^*(k, s)) \\ &= \sum_s \int d\vec{k} (|k, s) a(k, s) + |-k, -s) a^*(k, s)). \end{aligned}$$

7.1.5 Quantization

To quantize the Dirac equation with the Majorana condition we use the formalism of quantization of neutral fermionic systems [15].

We want to construct $(\mathcal{H}, \hat{H}, \Omega)$ satisfying the standard requirements of QM (1)-(3) and a distribution

$$\mathbb{R}^{1,3} \ni x \mapsto \hat{\phi}(x), \quad (7.4)$$

with values in $\mathbb{C}^4 \otimes B(\mathcal{H})$, satisfying the Majorana condition

$$\kappa \hat{\phi}^*(x) = \phi(x), \quad (7.5)$$

and such that the following conditions are true:

- (1) $(-i\gamma\partial + m)\hat{\phi}(x) = 0$;
- (2) $[\phi_a(0, \vec{x}), \phi_b^*(0, \vec{y})]_+ = 2\delta_{ab}\delta(\vec{x} - \vec{y})$;
- (3) $e^{it\hat{H}}\hat{\phi}(x^0, \vec{x})e^{-it\hat{H}} = \hat{\phi}(x^0 + t, \vec{x})$;
- (4) Ω is cyclic for $\hat{\phi}(x)$.

The above problem has an essentially unique solution, which we describe below.

Let $\mathcal{Z}_D \simeq L^2(\mathbb{R}^3, \mathbb{C}^2)$ denote the fermionic positive frequency Hilbert space defined in Subsubject. 6.1.8. We set $\mathcal{H} := \Gamma_a(\mathcal{Z}_D)$. Creation/annihilation operators on \mathcal{Z}_D will be denoted \hat{a}^*/\hat{a} . In particular, for k on shell and $s = \pm\frac{1}{2}$, we have creation operators, written below in both physicist's and mathematician's notation:

$$\hat{a}^*(k, s) = \hat{a}^*(|k, s\rangle). \quad (7.6)$$

The quantum field is

$$\hat{\phi}(x) := \sum_s \int \frac{d\vec{k}}{\sqrt{(2\pi)^3}} (u(k, s)e^{ikx}\hat{a}(k, s) + u(-k, -s)e^{-ikx}\hat{a}^*(k, s)).$$

The quantum Hamiltonian and momentum are

$$\begin{aligned} \hat{H} &:= \int \sum_s \hat{a}^*(k, s)\hat{a}(k, s)\varepsilon(\vec{k})d\vec{k}, \\ \vec{P} &:= \int \sum_s \hat{a}^*(k, s)\hat{a}(k, s)\vec{k}d\vec{k}. \end{aligned}$$

The whole $\mathbb{R}^{1,3} \rtimes Spin^\uparrow(1, 3)$ acts unitarily on \mathcal{H} . Moreover, if we set $\tilde{\phi}(x) := \beta\hat{\phi}^*(x)$, then

$$[\hat{\phi}_a(x), \tilde{\phi}_b(y)]_+ = 2S_{ab}(x - y). \quad (7.7)$$

We have

$$\begin{aligned} (\Omega|\hat{\phi}_a(x)\tilde{\phi}_b(y)\Omega) &= 2S_{ab}^{(+)}(x - y), \\ (\Omega|T(\hat{\phi}_a(x)\tilde{\phi}_b(y))\Omega) &= 2S_{ab}^c(x - y). \end{aligned}$$

For $f \in C_c^\infty(\mathbb{R}^{1,3}, \mathbb{C}^4)$ such that $\kappa \bar{f} = f$, we set

$$\hat{\phi}[f] := \int \overline{f(x)} \hat{\phi}(x) dx.$$

If we use the Majorana representation, so that $\kappa = \mathbb{1}$, we obtain an operator valued distribution satisfying the Wightman axioms with $\mathcal{D} := \Gamma_a^{\text{fin}}(\mathcal{Z}_D)$.

For an open set $\mathcal{O} \subset \mathbb{R}^{1,3}$ the field algebra is defined as

$$\mathfrak{F}(\mathcal{O}) := \{\hat{\phi}[f] : f \in C_c^\infty(\mathcal{O}, \mathbb{C}^4), \kappa \bar{f} = f\}''.$$

The observable algebra $\mathfrak{A}(\mathcal{O})$ is the even subalgebra of $\mathfrak{F}(\mathcal{O})$. The nets of algebras $\mathfrak{F}(\mathcal{O})$ and $\mathfrak{A}(\mathcal{O})$, $\mathcal{O} \subset \mathbb{R}^{1,3}$, satisfy the Haag-Kastler axioms.

7.1.6 Quantization in terms of smeared fields

There exists an alternative equivalent formulation of the quantization program, which uses the smeared fields instead of point fields. We look for a linear function

$$\mathcal{Y}_D \ni \zeta \mapsto \hat{\phi}((\zeta))$$

with values in bounded self-adjoint operators such that

- (1) $[\hat{\phi}((\zeta_1)), \hat{\phi}((\zeta_2))]_+ = 2\bar{\zeta}_1 \cdot \zeta_2$;
- (2) $\hat{\phi}((r_{(t, \vec{0})} \zeta)) = e^{it\hat{H}} \hat{\phi}((\zeta)) e^{-it\hat{H}}$;
- (3) Ω is cyclic for $\hat{\phi}((\zeta))$.

One can pass between these two versions of the quantization by

$$\hat{\phi}((\zeta)) = \int \overline{\zeta(t, \vec{x})} \hat{\phi}(t, \vec{x}) d\vec{x}. \quad (7.8)$$

7.2 Majorana fermions with a mass-like perturbation

7.2.1 Classical fields

The meaning of the expression a *mass-like perturbation* is slightly different for fermions, where we perturb m , and for bosons, where we perturb m^2 .

“Classical” Majorana fields with a mass-like perturbation satisfy the Majorana condition (7.2) and the equation

$$(-i\gamma_\mu \partial^\mu + m)\phi(x) = -\sigma(x)\phi(x), \quad (7.9)$$

where we assume that $\mathbb{R}^{1,3} \ni x \mapsto \sigma(x)$ is a given real Schwartz function.

Let us define the corresponding retarded and advanced propagators as the unique distributional solutions of

$$(-i\gamma_\mu \partial^\mu + \sigma(x))S^\pm(x, y) = \delta(x - y) \quad (7.10)$$

satisfying

$$\text{supp} S^\pm \subset \{x, y : x \in J^\pm(y)\}.$$

We also set

$$S(x, y) := S^+(x, y) - S^-(x, y).$$

Clearly

$$\text{supp}S \subset \{x, y : x \in J(y)\}.$$

The “classical” Majorana field coinciding with the free field at time $t = 0$ is defined as

$$\phi(t, \vec{x}) = \int S(t, \vec{x}, 0, \vec{y}) \beta \phi_{\text{fr}}(0, \vec{y}) d\vec{y}.$$

7.2.2 Lagrangian and Hamiltonian formalism

The Lagrangian density that yields (7.9) is

$$\mathcal{L}(x) = -\frac{1}{2} \left(\tilde{\phi}(x) \gamma^\mu (-i\partial_\mu) \phi(x) + i\partial_\mu \tilde{\phi}(x) \gamma^\mu \phi(x) \right) + \tilde{\phi}(x) (m + \sigma(x)) \phi(x),$$

where $\phi(x)$ are off-shell fields satisfying the Majorana condition (7.2).

We can introduce the *Hamiltonian density*

$$\begin{aligned} \mathcal{H}(x) &= \dot{\phi}(x) \frac{\mathcal{L}(x)}{\partial_{\dot{\phi}(x)}} - \mathcal{L}(x) \\ &= \frac{1}{2} \left(\phi^*(x) \vec{\alpha} (-i\vec{\partial}) \phi(x) + i\vec{\partial} \phi^*(x) \phi(x) \right) + \phi^*(x) (m + \sigma(x)) \beta \phi(x), \end{aligned}$$

and the *Hamiltonian*

$$H(t) = \int \mathcal{H}(t, \vec{x}) d\vec{x}.$$

7.2.3 Quantum fields

The quantum fields should satisfy the Majorana condition (7.5), the equation

$$(-i\gamma_\mu \partial^\mu + m) \hat{\phi}(x) = -\sigma(x) \hat{\phi}(x), \quad (7.11)$$

and they should coincide with the free fields at time $t = 0$:

$$\hat{\phi}(\vec{x}) := \hat{\phi}(0, \vec{x}) = \hat{\phi}_{\text{fr}}(0, \vec{x}).$$

The quantization amounts to putting “hats” onto (7.11).

We write the Schrödinger picture Hamiltonian as

$$\hat{H}(t) := \int : \hat{\phi}^*(\vec{x}) \left(\alpha_i i\partial_i + (m + \sigma(t, \vec{x})) \beta \right) \hat{\phi}(\vec{x}) : d\vec{x}.$$

The interaction picture Hamiltonian is

$$\hat{H}_{\text{Int}}(t) = \frac{1}{2} \int \sigma(t, \vec{x}) : \hat{\phi}_{\text{fr}}^*(t, \vec{x}) \beta \hat{\phi}_{\text{fr}}(t, \vec{x}) : d\vec{x}.$$

As usual, we define the scattering operator, scattering amplitudes, Green’s functions, amputated Green’s functions and the generating function.

7.2.4 Path integral formulation

The generating function (and hence all the other quantities introduced above) can be computed exactly. It equals

$$\begin{aligned}
Z(f) &= \det \left(\frac{(-i\gamma\partial + m + \sigma)}{(-i\gamma\partial + m + \sigma - i0)} \exp \left(-\sigma \frac{1}{-i\gamma\partial + m - i0} \right) \right)^{\frac{1}{2}} \\
&\quad \times \exp \left(\frac{i}{2} \bar{f} (-i\partial\gamma + m + \sigma - i0)^{-1} f \right) \\
&= \det \left((\mathbb{1} + \sigma S_{\text{fr}}^c) \exp(-\sigma S_{\text{fr}}^c) \right) \\
&\quad \times \exp \left(\frac{i}{2} \bar{f} S_{\text{fr}}^c (\mathbb{1} + \sigma S_{\text{fr}}^c)^{-1} f \right). \tag{7.12}
\end{aligned}$$

(7.12) can be expressed in terms of path integrals:

$$C \int_{\Pi} \prod_x d\phi(x) \exp \left(i \int (\mathcal{L}(x) - f(x)\phi(x)) dx \right).$$

Here, C is a normalization constant, which does not depend on f . As usual, the formula (7.13) is only symbolic, the full information is contained in (7.12).

One can derive Feynman rules fully analogous to the Feynman rules of bosonic mass-like perturbations.

7.2.5 Vacuum energy

The logarithm of the vacuum-to-vacuum scattering amplitude can be computed exactly:

$$\begin{aligned}
\mathcal{E} = i \log(\Omega|S\Omega) &= i \log Z(0) \\
&= \frac{i}{2} \text{Tr} \left(\log(1 + \sigma S^c) + \sigma S^c \right) \\
&= i \sum_{n=2}^{\infty} \frac{(-1)^{n+1}}{2n} \text{Tr}(\sigma S^c)^n =: \sum_{n=2}^{\infty} \mathcal{E}_n.
\end{aligned}$$

Note that $\mathcal{E}_n = -i \frac{D_n}{2n}$, where $D_n = (-1)^n \text{Tr}(\sigma S^c)^n$ is the value of the loop with n vertices, similarly to the bosonic case (2.112) except for a different sign.

7.2.6 Renormalization of the vacuum energy

The n th order contribution to the vacuum energy has the form

$$\begin{aligned}
\mathcal{E}_n &= \int \pi(k_1, \dots, k_n) \\
&\quad \times \sigma(k_1) \cdots \sigma(k_{n-1}) \sigma(-k_1 \cdots -k_{n-1}) \frac{dk_1}{(2\pi)^4} \cdots \frac{dk_{n-1}}{(2\pi)^4}. \tag{7.13}
\end{aligned}$$

For $n = 2, 3, 4$, \mathcal{E}_n are divergent and need renormalization.

Using the Pauli-Villars method we define for $n = 1, 2, 3$ the renormalized vacuum energy functions

$$\pi^{\text{ren}}(k_1, \dots, k_{n-1}) := \lim_{\Lambda \rightarrow \infty} (\pi_\Lambda(k_1, \dots, k_{n-1}) - \pi_\Lambda(0, \dots, 0)).$$

Thus

$$\begin{aligned} & \mathcal{E}_n^{\text{ren}} \\ = & \int \pi^{\text{ren}}(k_1, \dots, k_{n-1}) \sigma(k_1) \cdots \sigma(k_{n-1}) \sigma(-k_1 \cdots - k_{n-1}) \frac{dk_1}{(2\pi)^4} \cdots \frac{dk_{n-1}}{(2\pi)^4} \\ = & \lim_{\Lambda \rightarrow \infty} \left(\int \pi_\Lambda(k_1, \dots, k_{n-1}) \sigma(k_1) \cdots \sigma(k_{n-1}) \sigma(-k_1 \cdots - k_{n-1}) \frac{dk_1}{(2\pi)^4} \cdots \frac{dk_{n-1}}{(2\pi)^4} \right. \\ & \left. - \pi_\Lambda(0, \dots, 0) \int \sigma(x)^n dx \right). \end{aligned}$$

The renormalized scattering operator \hat{S}_{ren} is a well defined unitary operator. Formally, we have

$$\begin{aligned} \hat{S}_{\text{ren}} &= e^{(i\pi_\infty(0) \int \kappa(x)^2 dx + i\pi_\infty(0,0) \int \kappa(x)^3 dx + i\pi_\infty(0,0,0) \int \kappa(x)^4 dx)} \hat{S}. \\ \mathcal{L}_{\text{ren}}(x) &= \mathcal{L}(x) + \pi_\infty(0) \kappa(x)^2 + \pi_\infty(0,0) \kappa(x)^3 + \pi_\infty(0,0,0) \kappa(x)^4. \end{aligned}$$

7.2.7 Pauli-Villars renormalization of the 2nd order term

\mathcal{E}_3 and \mathcal{E}_4 are logarithmically divergent. Below we present computations only for \mathcal{E}_2 , which is quadratically divergent. As a special case of (7.13) for $n = 2$ we write

$$\mathcal{E}_2 = \int |\sigma(k)|^2 \pi(k^2) \frac{dk}{(2\pi)^4}.$$

Using the *Pauli-Villars regularization*, as in Subsubject. 5.2.11, we compute:

$$\begin{aligned}
& 4\pi_\Lambda(k^2) \\
= & -i \int \frac{d^4q}{(2\pi)^4} \sum_i C_i \text{tr} \frac{-(q + \frac{1}{2}k)\gamma + m_i}{((q + \frac{1}{2}k)^2 + m_i^2 - i0)} \frac{-(q - \frac{1}{2}k)\gamma + m_i}{((q - \frac{1}{2}k)^2 + m_i^2 - i0)} \\
= & -i \int \frac{d^4q}{(2\pi)^4} \sum_i C_i \frac{(-4q^2 + k^2 + 4m_i^2)}{((q + \frac{1}{2}k)^2 + m_i^2 - i0)((q - \frac{1}{2}k)^2 + m_i^2 - i0)} \\
= & -\frac{1}{(4\pi)^2} \int_0^\infty d\alpha_1 \int_0^\infty d\alpha_2 \sum_i C_i \left(\frac{4\alpha_1\alpha_2 k^2}{(\alpha_1 + \alpha_2)^2} + \frac{4m^2}{(\alpha_1 + \alpha_2)^2} + \frac{2i}{(\alpha_1 + \alpha_2)^3} \right) \\
& \times \exp\left(-i(\alpha_1 + \alpha_2)m_i^2 - i\frac{\alpha_1\alpha_2}{\alpha_1 + \alpha_2}k^2\right) \\
= & -\frac{1}{(4\pi)^2} \int_0^1 dv \int_0^\infty \frac{d\rho}{\rho} \sum_i C_i \left((1-v^2)k^2 + 4m^2 + \frac{2i}{\rho} \right) \\
& \times \exp\left(-i\rho\left(m_i^2 + \frac{1-v^2}{4}k^2\right)\right) \\
= & \frac{1}{(4\pi)^2} \int_0^1 dv \sum_i C_i \left((1-v^2)k^2 + 4m_i^2 \right) \log\left(m_i^2 + \frac{(1-v^2)}{4}k^2 - i0\right).
\end{aligned}$$

Note that at the end we use (A.24) besides (A.25), because of the quadratic divergence.

Finally, the *renormalized vacuum energy function* is defined as

$$\begin{aligned}
\pi^{\text{ren}}(k^2) &= \lim_{\Lambda \rightarrow \infty} \left(\pi_\Lambda(k^2) - \pi_\Lambda(0) \right) \tag{7.14} \\
&= -\frac{m^2}{(4\pi)^2} \int_0^1 \left(\frac{1}{2} + \frac{(1-v^2)k^2}{8m^2} \right) \log\left(1 + \frac{(1-v^2)k^2}{4m^2} - i0\right) dv.
\end{aligned}$$

A Appendix

A.1 Second quantization

A.1.1 Fock spaces

Let \mathcal{Z} be a Hilbert space. Let S_n denote the *permutation group of n elements* and $\sigma \in S_n$. $\Theta(\sigma)$ is defined as the unique operator in $B(\otimes^n \mathcal{Z})$ such that

$$\Theta(\sigma)g_1 \otimes \cdots \otimes g_n = g_{\sigma^{-1}(1)} \otimes \cdots \otimes g_{\sigma^{-1}(n)}, \quad g_1, \dots, g_n \in \mathcal{Z}.$$

$\Theta(\sigma)$ is unitary. We define the *symmetrization/antisymmetrization projections*

$$\Theta_s^n := \frac{1}{n!} \sum_{\sigma \in S_n} \Theta(\sigma), \quad \Theta_a^n := \frac{1}{n!} \sum_{\sigma \in S_n} \text{sgn}\sigma \Theta(\sigma).$$

In what follows we will consider in parallel the symmetric/antisymmetric, or bosonic/fermionic case. To facilitate notation we will write s/a for *either* s or a .

$\Theta_{s/a}^n$ are orthogonal projections. The n -particle bosonic/fermionic space is defined as

$$\otimes_{s/a}^n \mathcal{Z} := \Theta_{s/a}^n \otimes^n \mathcal{Z}. \quad (\text{A.1})$$

The bosonic/fermionic Fock space is

$$\Gamma_{s/a}(\mathcal{Z}) := \bigoplus_{n=0}^{\infty} \otimes_{s/a}^n \mathcal{Z}. \quad (\text{A.2})$$

The vacuum vector is $\Omega := 1 \in \otimes_{s/a}^0 \mathcal{Z} = \mathbb{C}$.

We use the convention saying that the tensor products and direct sums used in (A.1) and (A.2) are completed in their natural topology, so that n -particle spaces and Fock space are Hilbert spaces. Sometimes we may want a similar construction without the completion (in particular, if \mathcal{Z} is not a Hilbert space). Then we will speak about *algebraic n -particle spaces* or *algebraic Fock spaces*.

A.1.2 Creation/annihilation operators

For $g \in \mathcal{Z}$ we define the creation operator

$$\hat{a}^*(g)\Psi := \Theta_{s/a}^{n+1} \sqrt{n+1} g \otimes \Psi, \quad \Psi \in \otimes_{s/a}^n \mathcal{Z},$$

and the annihilation operator $\hat{a}(g) := (\hat{a}^*(g))^*$.

Above we used a compact notation for creation/annihilation operators popular among mathematicians. Physicists commonly prefer another notation, which is longer and less canonical, but often more flexible. In order to introduce it, we need to fix an identification of \mathcal{Z} with $L^2(\Xi)$ of some measure space Ξ with its elements called generically ξ and the measure called $d\xi$. For instance, Ξ can be \mathbb{R}^d with the Lebesgue measure. Every $g \in \mathcal{Z}$ can be represented as a function $\Xi \ni \xi \mapsto g(\xi)$. Then

$$\hat{a}^*(g) = \int g(\xi) \hat{a}^*(\xi) d\xi, \quad (\text{A.3})$$

$$\hat{a}(g) = \int \overline{g(\xi)} \hat{a}(\xi) d\xi. \quad (\text{A.4})$$

We will call the notation on the left of (A.3) and (A.4) “*mathematician’s notation*” and on the right “*physicist’s notation*”.

Sometimes one introduces formal symbols $|\xi\rangle$ treated as vectors, possibly nonnormalizable, such that for $g \in L^2(\Xi)$ we can write

$$g = \int |\xi\rangle g(\xi) d\xi, \quad g(\xi) = \langle \xi | g \rangle.$$

We have the following dictionary between creation operators written in the “physicist’s notation” (on the left) and the “mathematician’s notation” (on the right):

$$\hat{a}^*(\xi) = \hat{a}^*(|\xi\rangle), \quad (\text{A.5})$$

$$\int (\xi|g)\hat{a}^*(\xi)d\xi = \hat{a}^*(g). \quad (\text{A.6})$$

Let $[\cdot, \cdot]_-$, resp. $[\cdot, \cdot]_+$ denote the commutator, resp. anticommutator. Bosonic/fermionic creation and annihilation operators satisfy the canonical commutation/anticommutation relations, which in the “mathematician’s notation” read

$$\begin{aligned} [\hat{a}^*(f), \hat{a}^*(g)]_{\mp} &= [\hat{a}(f), \hat{a}(g)]_{\mp} = 0, \\ [\hat{a}(f), \hat{a}^*(g)]_{\mp} &= (f|g) = \int \overline{f(\xi)}g(\xi)d\xi, \end{aligned}$$

and in the “physicist’s notation”, at least for $\Xi = \mathbb{R}^d$, have the form

$$\begin{aligned} [\hat{a}^*(\xi), \hat{a}^*(\xi')]_{\mp} &= [\hat{a}(\xi), \hat{a}(\xi')]_{\mp} = 0, \\ [\hat{a}(\xi), \hat{a}^*(\xi')]_{\mp} &= \delta(\xi - \xi'). \end{aligned}$$

A.1.3 Weyl/antisymmetric and Wick quantization

Let

$$(\xi_1, \dots, \xi_m, \xi'_n, \dots, \xi'_1) \mapsto b(\xi_1, \dots, \xi_m, \xi'_n, \dots, \xi'_1) \quad (\text{A.7})$$

be a complex function, symmetric/antisymmetric separately wrt the first m and the last n arguments. Let us introduce the following expression:

$$\begin{aligned} &\int \dots \int b(\xi_1, \dots, \xi_m, \xi'_n, \dots, \xi'_1) \\ &\times a^*(\xi_1) \dots a^*(\xi_m) a(\xi'_n) \dots a(\xi'_1) d\xi_1 \dots d\xi_m d\xi'_n \dots d\xi'_1, \end{aligned} \quad (\text{A.8})$$

where $a(\xi)$ and $a^*(\xi)$ are commuting/anticommuting symbols.

In the symmetric case (A.8) can be interpreted as a *polynomial on* $\mathcal{Z} \oplus \overline{\mathcal{Z}}$. Indeed, if we interpret the symbols $a(\xi)$ as the evaluations of $g \in \mathcal{Z} = L^2(\mathbb{R}^d)$:

$$\langle a(\xi)|g \rangle := g(\xi), \quad \langle a^*(\xi)|g \rangle := \overline{g(\xi)},$$

then (A.8) has the meaning of a polynomial function. It is common to use the name a *polynomial* for (A.8) also in the antisymmetric case.

The *Wick quantization of (A.8)* is the operator on the Fock space given by the same expression, except that we put the “hats” on a and a^* . Note that the creation operators are on the left and annihilation operators are on the right:

$$\begin{aligned} &\int b(\xi_1, \dots, \xi_m, \xi'_n, \dots, \xi'_1) \\ &\times \hat{a}^*(\xi_1) \dots \hat{a}^*(\xi_m) \hat{a}(\xi'_n) \dots \hat{a}(\xi'_1) d\xi_1, \dots, \xi_n d\xi'_1 \dots d\xi'_m. \end{aligned}$$

In practice we often have some fields, say $\varphi_1(\xi)$, $\varphi_2(\xi)$, that can be written as linear combinations of $a(\xi)$ and $a^*(\xi)$, eg.

$$\varphi_i(\xi) = \int A_i(\xi)a(\xi) + \int B_i(\xi)a^*(\xi).$$

Their quantizations are denoted by “hats”:

$$\hat{\varphi}_i(\xi) = \int A_i(\xi)\hat{a}(\xi) + \int B_i(\xi)\hat{a}^*(\xi).$$

Suppose we have a polynomial

$$\sum_{i_1, \dots, i_m} \int \cdots \int c_{i_1, \dots, i_m}(\xi_1, \dots, \xi_m) \varphi_{i_1}(\xi_1) \cdots \varphi_{i_m}(\xi_m) d\xi_1 \cdots d\xi_m. \quad (\text{A.9})$$

We assume that the coefficients $c_{i_1, \dots, i_m}(\xi_1, \dots, \xi_m)$ are symmetric/antisymmetric. The most natural quantization of (A.9) is the operator on the Fock space given by the same expression, where we just put “hats” on the fields. It is called the *Weyl quantization* in the bosonic case. In the fermionic case this quantization seems to have no established name, although it would be tempting to call it the *fermionic Weyl quantization*. Following [15], we will call it the *antisymmetric quantization*.

By inserting (A.9), we obtain a polynomial expressed in terms of $a(\xi)$ and $a^*(\xi)$. Its Wick quantization has the traditional notation where the expression decorated with hats is put between double dots:

$$: \sum_{i_1, \dots, i_m} \int \cdots \int c_{i_1, \dots, i_m}(\xi_1, \dots, \xi_m) \hat{\varphi}(\xi_1) \cdots \hat{\varphi}(\xi_m) d\xi_1 \cdots d\xi_m :.$$

For 1st order polynomials their Wick quantization obviously coincides with their Weyl/antisymmetric quantization:

$$: \int f(\xi) \hat{\varphi}(\xi) d\xi : = \int f(\xi) \hat{\varphi}(\xi) d\xi.$$

We will often use Wick quantizations of second degree polynomials. For instance, let $c(\xi, \xi')$ be a symmetric/antisymmetric function. Then the Wick and Weyl/antisymmetric quantizations differ by the vacuum expectation value:

$$\begin{aligned} & : \int \int c(\xi, \xi') \hat{\varphi}(\xi) \hat{\varphi}(\xi') d\xi d\xi' : \\ &= \int \int c(\xi, \xi') \left(A(\xi)A(\xi')\hat{a}^*(\xi)\hat{a}^*(\xi') + A(\xi)B(\xi')\hat{a}^*(\xi)\hat{a}(\xi') \right. \\ & \quad \left. \pm B(\xi)A(\xi')\hat{a}^*(\xi')\hat{a}(\xi) + B(\xi)B(\xi')\hat{a}(\xi)\hat{a}(\xi') \right) d\xi d\xi' \\ &= \int \int c(\xi, \xi') \hat{\varphi}(\xi) \hat{\varphi}(\xi') d\xi d\xi' - \int \int c(\xi, \xi') (\Omega | \hat{\varphi}(\xi) \hat{\varphi}(\xi') \Omega) d\xi d\xi'. \end{aligned}$$

A.1.4 Second quantization of operators

For a contraction q on \mathcal{Z} we define the operator $\Gamma(q)$ on $\Gamma_{s/a}(\mathcal{Z})$ by

$$\Gamma(q)\Big|_{\otimes_{s/a}^n \mathcal{Z}} = q \otimes \cdots \otimes q\Big|_{\otimes_{s/a}^n \mathcal{Z}}.$$

$\Gamma(q)$ is called the *second quantization of q* .

Similarly, for an operator h we define the operator $d\Gamma(h)$ by

$$d\Gamma(h)\Big|_{\otimes_{s/a}^n \mathcal{Z}} = h \otimes 1^{(n-1)\otimes} + \cdots + 1^{(n-1)\otimes} \otimes h\Big|_{\otimes_{s/a}^n \mathcal{Z}}.$$

$d\Gamma(h)$ is called the (*infinitesimal*) *second quantization of h* .

If h is the multiplication operator by $h(\xi)$, then using physicist's notation we have

$$d\Gamma(h) = \int h(\xi) \hat{a}^*(\xi) \hat{a}(\xi) d\xi.$$

Note the identity $\Gamma(e^{ith}) = e^{itd\Gamma(h)}$.

A.1.5 Implementability of Bogoliubov translations

Consider bosonic creation/annihilation operators. Let $\xi \mapsto f(\xi)$ be a complex function. Set

$$\begin{aligned} \hat{a}_1^*(\xi) &= \hat{a}^*(\xi) + \overline{f(\xi)}, \\ \hat{a}_1(\xi) &= \hat{a}(\xi) + f(\xi). \end{aligned}$$

A proof of the following well-known fact can be found eg. in [15].

Theorem A.1 *There exists a unitary operator U on the Fock space such that*

$$U \hat{a}^*(\xi) U^* = \hat{a}_1^*(\xi), \quad U \hat{a}(\xi) U^* = \hat{a}_1(\xi),$$

iff

$$\int |f(\xi)|^2 d\xi < \infty.$$

Up to a phase factor

$$U = \exp \left(\int (\hat{a}(\xi) f(\xi) - \hat{a}^*(\xi) \overline{f(\xi)}) d\xi \right).$$

The following formula is a time-dependent generalization of the well-known identity $e^{i\hat{a}^*(f)+i\hat{a}(f)} = e^{-\frac{1}{2}(f|f)} e^{i\hat{a}^*(f)} e^{i\hat{a}(f)}$:

$$\begin{aligned} & \text{Texp} \left(i\hat{a}^* \left(\int f(t) dt \right) + i\hat{a} \left(\int f(t) dt \right) \right) \\ &= e^{-\int \int (f(t_1)|f(t_2))\theta(t_1-t_2)dt_1dt_2} e^{i\hat{a}^* \left(\int f(t) dt \right)} e^{i\hat{a} \left(\int f(t) dt \right)}. \end{aligned} \tag{A.10}$$

A.1.6 Implementability of Bogoliubov rotations

We will treat simultaneously the bosonic and fermionic case. The upper signs will always correspond to the bosonic case and lower to the fermionic case.

Let p, q be operators with the integral kernels $p(\xi, \xi'), q(\xi, \xi')$. We assume that $q(\xi, \xi') = \pm q(\xi', \xi)$. Set

$$\hat{a}_1^*(\xi) = \int (p(\xi, \xi')\hat{a}^*(\xi) + q(\xi, \xi')\hat{a}(\xi'))d\xi', \quad (\text{A.11})$$

$$\hat{a}_1(\xi) = \int (\overline{q(\xi, \xi')}\hat{a}^*(\xi') + \overline{p(\xi, \xi')}\hat{a}(\xi))d\xi'. \quad (\text{A.12})$$

Assume that

$$\begin{aligned} p^*p \mp q^\# \bar{q} &= \mathbb{1}, & p^*q \mp q^\# \bar{p} &= 0, \\ pp^* \mp qq^* &= \mathbb{1}, & pq^\# \mp qp^\# &= 0, \end{aligned}$$

which guarantees that \hat{a}_1^*, \hat{a}_1 satisfy the same commutation/anticommutation relations as \hat{a}^*, \hat{a} .

Here, we use the following notation: For an operator p we will write p^* for its Hermitian conjugate, $p^\#$ for its transpose of p and \bar{p} for its complex conjugate. If the integral kernel of p is $p(\xi, \xi')$, then clearly

$$p^*(\xi, \xi') = \overline{p(\xi', \xi)}, \quad p^\#(\xi, \xi') = p(\xi', \xi), \quad \bar{p}(\xi, \xi') = \overline{p(\xi, \xi')}.$$

Theorem A.2 *There exists a unitary U on the Fock space such that*

$$U\hat{a}_1^*(\xi)U^* = \hat{a}_1^*(\xi), \quad U\hat{a}_1(\xi)U^* = \hat{a}_1(\xi),$$

iff q is Hilbert-Schmidt, that means,

$$\int \int |q(\xi, \xi')|^2 d\xi d\xi' < \infty.$$

The above theorem is called the *Shale criterion* [49] in the bosonic and the *Shale-Stinespring criterion* [50] in the fermionic case. See also eg. [15].

A.1.7 Infimum of a van Hove Hamiltonian

Consider a bosonic Hamiltonian of the form

$$H := \int \varepsilon(\xi)\hat{a}^*(\xi)\hat{a}(\xi)d\xi + \int v(\xi)\hat{a}^*(\xi)d\xi + \int \overline{v(\xi)}\hat{a}(\xi)d\xi. \quad (\text{A.13})$$

Such Hamiltonians are sometimes called *van Hove Hamiltonians* [13, 15]. Assume that ε is positive. We would like to compute the infimum of the spectrum of H , denoted $\inf H$.

By completing the square we can rewrite (A.13) as

$$\int \varepsilon(\xi) \left(\hat{a}^*(\xi) + \frac{\overline{v(\xi)}}{\varepsilon(\xi)} \right) \left(\hat{a}(\xi) + \frac{v(\xi)}{\varepsilon(\xi)} \right) d\xi - \int \frac{|v(\xi)|^2}{\varepsilon(\xi)} d\xi. \quad (\text{A.14})$$

It is easy to see that the infimum of the first term in (A.14) is zero. Hence

$$\inf H = - \int \frac{|v(\xi)|^2}{\varepsilon(\xi)} d\xi. \quad (\text{A.15})$$

A.1.8 Infimum of a Bogoliubov Hamiltonian

Consider a bosonic or fermionic Hamiltonian

$$\begin{aligned} H := & \int h(\xi, \xi') (\hat{a}^*(\xi) \hat{a}(\xi') \pm \hat{a}(\xi) \hat{a}^*(\xi')) d\xi d\xi' \\ & + \int (g(\xi, \xi') \hat{a}^*(\xi) \hat{a}^*(\xi') \pm \overline{g(\xi, \xi')} \hat{a}(\xi) \hat{a}(\xi')) d\xi d\xi'. \end{aligned} \quad (\text{A.16})$$

We assume that $\overline{h(\xi, \xi')} = h(\xi', \xi)$, $g(\xi, \xi') = \pm g(\xi', \xi)$. We will call (A.16) *Bogoliubov Hamiltonians*. Note that (A.16) is the Weyl/antisymmetric quantization of the corresponding classical quadratic Hamiltonian. In the case of an infinite number of degrees of freedom it is often ill defined, but even then it is useful to consider such formal expressions.

We have the following formula for the infimum of H [15]:

$$\inf H = \pm \frac{1}{2} \text{Tr} \begin{bmatrix} h^2 \mp gg^* & \mp hg \pm gh^\# \\ g^*h - h^\#g^* & h^{\#2} \mp g^*g \end{bmatrix}^{\frac{1}{2}}. \quad (\text{A.17})$$

Here, we write h for the operator with the integral kernel $h(\xi, \xi')$ and g for the operator with the integral kernel $g(\xi, \xi')$.

Consider the Wick ordered version of (A.16):

$$\begin{aligned} :H: := & 2 \int h(\xi, \xi') \hat{a}^*(\xi) \hat{a}(\xi') d\xi d\xi' \\ & + \int (g(\xi, \xi') \hat{a}^*(\xi) \hat{a}^*(\xi') \pm \overline{g(\xi, \xi')} \hat{a}(\xi) \hat{a}(\xi)) d\xi d\xi'. \end{aligned} \quad (\text{A.18})$$

(In the case an infinite number of degrees of freedom $:H:$ has a better chance to be well defined compared with H). The formula for the infimum of $:H:$ is more complicated, but is more likely to lead to a finite expression [15]:

$$\inf :H: = \frac{1}{2} \text{Tr} \left(\pm \begin{bmatrix} h^2 \mp gg^* & \mp hg \pm gh^\# \\ g^*h - h^\#g^* & h^{\#2} \mp g^*g \end{bmatrix}^{\frac{1}{2}} \mp \begin{bmatrix} h & 0 \\ 0 & h^\# \end{bmatrix} \right). \quad (\text{A.19})$$

A.2 Miscellanea

A.2.1 Identities for Feynman integrals

$$\frac{1}{A - i0} = i \int_0^\infty d\alpha \exp(-i\alpha A), \quad (\text{A.20})$$

$$p_\mu = i\partial_{z_\mu} \exp(-ipz) \Big|_{z=0}, \quad (\text{A.21})$$

$$\int \frac{dp}{(2\pi)^4} \exp(-i(ap^2 + bp)) = i \frac{\text{sgn}(a)}{(4\pi)^2 a^2} \exp(ib^2/4a). \quad (\text{A.22})$$

Using these identities, a typical evaluation of a loop integral goes as follows:

$$\begin{aligned} & \frac{i}{(2\pi)^4} \int \frac{P(q) dq}{(a_1 q^2 + 2b_1 q + c_1 - i0) \cdots (a_n q^2 + 2b_n q + c_n - i0)} \\ &= \frac{i^{n+1}}{(2\pi)^4} \int_0^\infty d\alpha_1 \cdots \int_0^\infty d\alpha_n \int dq P(q) \\ & \quad \times \exp\left(-i\alpha_1(a_1 q^2 + 2b_1 q + c_1) \cdots - i\alpha_n(a_n q^2 + 2b_n q + c_n)\right) \\ &= \frac{i^{n+1}}{(2\pi)^4} \int_0^\infty d\alpha_1 \cdots \int_0^\infty d\alpha_n \int dq P(i\partial_z) \exp\left(-i(\alpha_1 a_1 \cdots + \alpha_n a_n) q^2 \right. \\ & \quad \left. - i(\alpha_1 b_1 \cdots + \alpha_n b_n + z)q - i(\alpha_1 c_1 \cdots + \alpha_n c_n)\right) \Big|_{z=0} \\ &= -\frac{i^n}{(4\pi)^2} \int_0^\infty d\alpha_1 \cdots \int_0^\infty d\alpha_n (\alpha_1 a_1 \cdots + \alpha_n a_n)^{-2} P(i\partial_z) \\ & \quad \times \exp\left(i \frac{(\alpha_1 b_1 \cdots + \alpha_n b_n + z)^2}{4(\alpha_1 a_1 \cdots + \alpha_n a_n)} - i(\alpha_1 c_1 \cdots + \alpha_n c_n)\right) \Big|_{z=0}. \end{aligned} \quad (\text{A.23})$$

If $\sum C_i = 0$, then

$$\int_0^\infty \sum_i C_i \frac{d\rho}{\rho} e^{-i\rho A_i} = -\sum_i C_i \log(A_i - i0). \quad (\text{A.24})$$

If in addition $\sum C_i A_i = 0$, then

$$\int_0^\infty \sum_i C_i \frac{d\rho}{\rho^2} e^{-i\rho A_i} = -\sum_i C_i A_i \log(A_i - i0). \quad (\text{A.25})$$

$$\begin{aligned} \int \log(A^2 - w^2) dw &= w \log(A^2 - w^2) - 2w \\ & \quad + A \log \frac{(A+w)}{(A-w)}, \quad 0 < w < A; \end{aligned} \quad (\text{A.26})$$

$$\begin{aligned} \int w^2 \log(A^2 - w^2) dw &= \frac{w^3}{3} \log(A^2 - w^2) - \frac{2w^3}{9} - \frac{2A^2 w}{3} \\ & \quad + \frac{A^3}{3} \log \frac{(A+w)}{(A-w)}, \quad 0 < w < A. \end{aligned} \quad (\text{A.27})$$

A.2.2 Identities for the dimensional regularization

The *Feynman identity*:

$$\frac{1}{AB} = \frac{1}{2} \int_{-1}^1 \frac{dv}{\left(\frac{1}{2}(A+B) + \frac{1}{2}(A-B)v\right)^2}. \quad (\text{A.28})$$

The behavior of Γ around 0:

$$\Gamma(2 - d/2) \simeq \frac{1}{2 - d/2} - \gamma. \quad (\text{A.29})$$

The area of the unit $d - 1$ -dimensional sphere:

$$\Omega_d = \frac{2\pi^{d/2}}{\Gamma(d/2)}. \quad (\text{A.30})$$

Integrals, which can be reduced to special cases of the Euler integral:

$$\int_0^\infty \frac{t^{d-1}}{(t^2 + A^2)^2} dt = \frac{1}{2} (A^2)^{-2+d/2} \Gamma(d/2) \Gamma(2 - d/2), \quad (\text{A.31})$$

$$\begin{aligned} \int_0^\infty \frac{t^{d+1}}{(t^2 + A^2)^2} dt &= \frac{1}{2} (A^2)^{-1+d/2} \Gamma(1 + d/2) \Gamma(1 - d/2) \\ &= \frac{1}{2} (A^2)^{-1+d/2} \Gamma(d/2) \Gamma(2 - d/2) (-1 + 2/d)^{-1}. \end{aligned} \quad (\text{A.32})$$

Typical integrals:

$$\begin{aligned} &\frac{\mu^{4-d} \Omega_d}{(2\pi)^d} \int_0^\infty \frac{|q|^{d-1}}{(q^2 + A^2)^2} d|q| \\ &= \frac{1}{(4\pi)^2} \left(\frac{\mu^2 4\pi}{A^2} \right)^{2-d/2} \Gamma(2 - d/2) \\ &\approx \frac{1}{(4\pi)^2} \left(1 + (2 - d/2) \log \frac{\mu^2 4\pi}{A^2} \right) \left(\frac{1}{2 - d/2} - \gamma \right) \\ &\approx \frac{1}{(4\pi)^2} \left(-\gamma + \log \frac{\mu^2 4\pi}{A^2} + \frac{1}{(2 - d/2)} \right), \end{aligned} \quad (\text{A.33})$$

$$\begin{aligned} &\frac{\mu^{4-d} \Omega_d}{(2\pi)^d} \int_0^\infty (-1 + 2/d) \frac{|q|^{d+1}}{(q^2 + A^2)^2} d|q| \\ &= \frac{A^2}{(4\pi)^2} \left(\frac{\mu^2 4\pi}{A^2} \right)^{2-d/2} \Gamma(2 - d/2) \\ &\approx \frac{A^2}{(4\pi)^2} \left(1 + (2 - d/2) \log \frac{\mu^2 4\pi}{A^2} \right) \left(\frac{1}{2 - d/2} - \gamma \right) \\ &\approx \frac{A^2}{(4\pi)^2} \left(-\gamma + \log \frac{\mu^2 4\pi}{A^2} + \frac{1}{(2 - d/2)} \right). \end{aligned} \quad (\text{A.34})$$

A.2.3 Operator identities

If A is a positive self-adjoint operator, then

$$A^{1/2} = \int \frac{A}{(A + \tau^2)} \frac{d\tau}{2\pi}, \quad (\text{A.35})$$

$$\begin{aligned} A^{-1/2} &= \int \frac{1}{(A + \tau^2)} \frac{d\tau}{2\pi} \\ &= -2 \int \frac{1}{(A + \tau^2)^2} \tau^2 \frac{d\tau}{2\pi}. \end{aligned} \quad (\text{A.36})$$

In the following identity κ is a certain operator. It is useful when studying n th order loop diagrams:

$$\begin{aligned} &\int \text{Tr} \frac{1}{(A + \tau^2)^2} \kappa \left(\frac{1}{(A + \tau^2)} \kappa \right)^{n-1} \tau^2 \frac{d\tau}{2\pi} \\ &= -\frac{1}{2n} \int \text{Tr} \left(\frac{1}{(A + \tau^2)} \kappa \right)^n \frac{d\tau}{2\pi}. \end{aligned} \quad (\text{A.37})$$

A.2.4 Coulomb and Yukawa potential

If $\rho \in C_c(\mathbb{R}^3)$, then

$$\rho = -\Delta f$$

has a unique solution in functions that decay at infinity given by

$$f(\vec{x}) = (-\Delta)^{-1} \rho(\vec{x}) = \int \frac{1}{4\pi|\vec{x} - \vec{y}|} \rho(\vec{y}) d\vec{y}. \quad (\text{A.38})$$

For large $|\vec{x}|$, (A.38) has the asymptotics

$$\frac{1}{4\pi|\vec{x}|} \int \rho(\vec{y}) d\vec{y} + O\left(\frac{1}{|\vec{x}|^2}\right). \quad (\text{A.39})$$

More generally

$$(m^2 - \Delta)^{-1} \rho(\vec{x}) = \int \frac{e^{-m|\vec{x} - \vec{y}|}}{4\pi|\vec{x} - \vec{y}|} \rho(\vec{y}) d\vec{y}. \quad (\text{A.40})$$

A.2.5 Vector fields

Consider a vector field $\mathbb{R}^3 \ni \vec{x} \mapsto \vec{A}(\vec{x}) \in \mathbb{R}^3$. We say that it is *transversal* if

$$\text{div} \vec{A}(\vec{x}) = 0.$$

If it is not necessarily transversal but sufficiently nice, its *transversal part* is defined as

$$\vec{A}_{\text{tr}}(\vec{x}) := \vec{A}(\vec{x}) + (-\Delta)^{-1} \vec{\partial} \text{div} \vec{A}(\vec{x}). \quad (\text{A.41})$$

We have the identities

$$\begin{aligned} \int \vec{A}(\vec{x})^2 d\vec{x} &= \int \vec{A}_{\text{tr}}(\vec{x})^2 d\vec{x} + \int ((-\Delta)^{-1/2} \text{div} \vec{A}(\vec{x}))^2 d\vec{x}, \\ \int (\vec{\partial} \vec{A}(\vec{x}))^2 d\vec{x} &= \int (\vec{\partial} \vec{A}_{\text{tr}}(\vec{x}))^2 d\vec{x} + \int (\text{div} \vec{A}(\vec{x}))^2 d\vec{x}, \end{aligned} \quad (\text{A.42})$$

$$\int (\vec{\partial} \vec{A}_{\text{tr}}(\vec{x}))^2 d\vec{x} = \frac{1}{2} \int (\text{rot} \vec{A}(\vec{x}))^2 d\vec{x}. \quad (\text{A.43})$$

A.2.6 Dispersion relations

The *principal value* of $\frac{1}{\xi}$, denoted $\mathcal{P}\frac{1}{\xi}$, is the distribution acting on a test function f as

$$\mathcal{P} \int \frac{f(\xi)}{\xi} d\xi := \lim_{\epsilon \searrow 0} \left(\int_{-\infty}^{-\epsilon} + \int_{\epsilon}^{\infty} \right) \frac{f(\xi)}{\xi} d\xi.$$

It appears in the *Sochocki formula*

$$\frac{1}{\xi \pm i0} = \lim_{\epsilon \searrow 0} \frac{1}{\xi \pm i\epsilon} = \mp i\pi \delta(\xi) + \mathcal{P}\frac{1}{\xi}.$$

Let f be holomorphic on $\{\text{Im}z > 0\}$ with continuous boundary values at the real line. Let $f = f_{\text{R}} + i f_{\text{I}}$ be its decomposition into the real and imaginary part. The following theorem follows easily from the Cauchy formula and describes what physicists call *dispersion relations*:

Theorem A.3 *Assume that $f \in C^1(\mathbb{R})$, $\frac{f}{1+|E|} \in L^1(\mathbb{R})$ and on the upper half-plane $\lim_{|E| \rightarrow \infty} f(E) = 0$. Then for $E \in \mathbb{R}$*

$$\begin{aligned} f_{\text{R}}(E + i0) &= \frac{1}{\pi} \mathcal{P} \int \frac{f_{\text{I}}(\xi + i0)}{\xi - E} d\xi, \\ f_{\text{I}}(E + i0) &= -\frac{1}{\pi} \mathcal{P} \int \frac{f_{\text{R}}(\xi + i0)}{\xi - E} d\xi. \end{aligned}$$

Sometimes a function f does not have enough decay, and instead we can apply Thm A.3 to its derivative. Then by integrating we obtain the so-called *once subtracted dispersion relations*.

Theorem A.4 *Assume that $f \in C^2(\mathbb{R})$, $\frac{f'}{1+|E|} \in L^1(\mathbb{R})$ and on the upper half-plane $\lim_{|E| \rightarrow \infty} f'(E) = 0$. Then for $E \in \mathbb{R}$*

$$\begin{aligned} f_{\text{R}}(E + i0) &= f_{\text{R}}(0 + i0) + \frac{1}{\pi} \mathcal{P} \int f_{\text{I}}(\xi + i0) \left(\frac{1}{\xi - E} - \frac{1}{\xi} \right) d\xi, \\ f_{\text{I}}(E + i0) &= f_{\text{I}}(0 + i0) - \frac{1}{\pi} \mathcal{P} \int f_{\text{R}}(\xi + i0) \left(\frac{1}{\xi - E} - \frac{1}{\xi} \right) d\xi. \end{aligned}$$

References

- [1] Asmuß, B. 1990: Zur Quantentheorie geladener Klein-Gordon Teilchen in äußeren Feldern, PhD Thesis at Fernuniversität Hagen
- [2] Araki, H., 2000: *Mathematical Theory of Quantum Fields* Oxford University Press
- [3] Bär, C., Ginoux, N., Pfäffle, F., 2007: *Wave equation on Lorentzian manifolds and quantization*, ESI Lectures in Mathematics and Physics, EMS.
- [4] Baez, J.C., Segal, I.E., Zhou, Z., 1991: *Introduction to algebraic and constructive quantum field theory*, Princeton University Press.
- [5] Bialynicki-Birula, I., Bialynicka-Birula, Z. 1975: Quantum Electrodynamics, Pergamon, Oxford 1975,
- [6] Bleuler, K. 1950: Helv.Phys.Acta 23, 567586
- [7] Bloch, F., Nordsieck, A., 1937: Note on the radiation field of the electron, Phys. Rev. **52**, 54-59.
- [8] Bogoliubov, N.N., Logunov, A.A., Oksak, A.I., Todorov, I.T., 1990: General Principles of Quantum Field Theory, Kluwer Academic Publishers
- [9] Brunetti, R., Fredenhagen, K., 2009: Quantum field theory on curved backgrounds, in Bär, C. and Fredenhagen, K., editors, *Quantum Field Theory on Curved Spacetimes*, Lecture Notes in Physics 786, Springer
- [10] Cardona, A., Ducourtieux, C., Paycha, S. 2003: From Tracial Anomalies to Anomalies in Quantum Field Theory, Commun. Math. Phys. 242, 31-65
- [11] Carey, A.L., Ruijsenaars, S.N.M. 1987: On fermion gauge groups, current algebras and Kac-Moody algebras, Acta Applicandae Mathematica 10, 1-86
- [12] Deckert, D.-A., Dürr, D., Merkl, F., Schottenloher, M., 2010: Time Evolution of the External Field Problem in QED J. Math. Phys. 51
- [13] Dereziński, J., 2003: Van Hove Hamiltonians—exactly solvable models of the infrared and ultraviolet problem, Ann. Henri Poincaré **4**, 713-738.
- [14] Dereziński J., Gérard C. 1997: *Scattering Theory of Classical and Quantum N-Particle Systems*, Texts and Monographs in Physics, Springer
- [15] Dereziński, J., Gérard, G. 2013: *Mathematics of quantization and quantum fields*, Cambridge University Press
- [16] Gelfand, I.M. and coauthors, 1958: Generalized Functions I-V (Russian), Fizmatgiz
- [17] Greiner, W., Reinhardt, J. 2009: Quantum Electrodynamics, 4th ed., Springer

- [18] Gravejat, P., Hainzl, C., Lewin, M., Séré 2013: Construction of the Pauli-Villars-regulated Dirac vacuum in electromagnetic fields, Arch. for Rational Mach. and An. DOI 10.1007/s00205-012-0609-1
- [19] Gupta, S. 1950: Proc. Phys. Soc. A63, 681691
- [20] Fujikawa, K., Suzuki, H., 2004: Path Integrals and Quantum Anomalies, Clarendon Press, Oxford
Physics Letters B
- [21] Gracia-Bondia, J.M. 2000: The phase of the scattering matrix, Phys. Lett. B 482, 315322
- [22] Haag, R., 1992: *Local quantum physics*, Texts and Monographs in Physics, Springer.
- [23] Haag, R., Kastler, D., 1964: An algebraic approach to quantum field theory, Journ. Math. Phys. **5**, 848-862.
- [24] Heisenberg, W., Euler, H., 1936: Folgerungen aus der Diracschen Theorie des Positrons Z. Phys. 98, 714
- [25] Hochstenbach, W. J. M. A. 1976 Field theory with an external potential Comm. Math. Phys. 51, 211–217
- [26] Itzykson, C., Zuber, J.-B. 1980: Quantum Field Theory, McGraw Hill
- [27] Jauch, J. M., Rohrlich, F., 1976: *The theory of photons and electrons*, 2nd edition, Springer.
- [28] Kibble, T. W. B., 1968: Coherent soft-photon states and infrared divergences I. Classical currents, J. Math. Phys. **9**, 315-324.
- [29] Klaus, M. 1980: Nonregularity of the Coulomb potential in quantum electrodynamics Helv. Phys. Acta 53 36–39
- [30] Klaus, M. and Scharf, G. 1977: The regular external field problem in quantum electrodynamics, Helv Phys. Acta, 50, 779–802
- [31] Labzowski L.N. Klimchitskaya G. Dmitriev Y.: Relativistic Effects in Spectra of Atomic Systems. IOP Publ. Bristol 1993
- [32] Langmann, E. 2001: Generalized YangMills actions from Dirac operator determinants, J. Math. Phys. 42, 5238
- [33] Langmann, E, 1994: Fermion current algebras and Schwinger terms in (3+1)-dimensions, Commun. Math. Phys. 162, 1-32
- [34] Langmann, E., Semenoff, G.W. 1994: QCD1+1 with massless quarks and gauge covariant Sugawara construction, Phys. Lett. B, 341, 195204

- [35] Langmann, E., Mickelsson, J. 1996: Scattering matrix in external field problems, *J. Math. Phys.* 37, 3933
- [36] L.E.Lundberg, Relativistic Quantum Theory for Charged Spinless Particles in External Vector Fields *Commun. Math. Phys.* 31 (1973) 295-316
- [37] Lundberg, L.-E. 1973: Spectral and scattering theory for the Klein-Gordon equation, *Comm. Math. Phys.* 31 243–257
- [38] Lundberg, L.-E. 1973: Relativistic quantum theory for charged spinless particles in external vector fields, *Comm. Math Phys.* 31 295–316
- [39] Meissner, K.A. 2002: Classical field theory (in Polish), Wydawnictwo Naukowe PWN
- [40] Molinari, G.L. 2007: Another proof of Gell-Mann and Lows theorem, *J. Math. Phys.* 48, 052113
- [41] Nenciu, G. and Scharf, G., 1978: On regular external fields in quantum electrodynamics *Helv. Phys. Acta* 51, 412–424
- [42] Reed, M., Simon, B., 1980: *Methods of Modern Mathematical Physics, I. Functional Analysis*, London, Academic Press.
- [43] Reed, M., Simon, B., 1975: *Methods of Modern Mathematical Physics, II. Fourier Analysis, Self-Adjointness*, London, Academic Press.
- [44] Ruijsenaars, S. N. M. 1977: On Bogoliubov transformations for systems of relativistic charged particles, *J. Mathematical Phys.* 18, 517–526
- [45] Scharf, G. 1995: *Finite Quantum Electrodynamics. The Causal Approach*, Springer
- [46] Schroer, B., Seiler, R., Swieca, J. A. 1970: Problems of stability for quantum fields in external time-dependent potentials *Phys. Rev. D* 2, 927–2937
- [47] Schweber, S. S., 1962: *Introduction to non-relativistic quantum field theory*, Harper and Row.
- [48] Seiler, R. 1972: Quantum theory of particles with spin zero and one half in external fields, *Comm. Math. Phys. Communications in Mathematical Physics*, 25
- [49] Shale, D., 1962: Linear symmetries of free boson fields, *Trans. Amer. Math. Soc.* **103**, 149-167.
- [50] Shale, D. and Stinespring, W.F., 1964: States on the Clifford algebra, *Ann. Math.* **80**, 365-381.
- [51] Srednicki, M., 2007: *Quantum Field Theory*, Cambridge University Press.

- [52] Sternberg, S., 1994: Group Theory and Physics, Cambridge University Press
- [53] Streater, R.F, Wightman, A.S., 1964: *PCT, spin and statistics and all that*, W.A.Benjamin, New York-Amsterdam.
- [54] Thirring, W., Narnhofer, H., 1992: Covariant QED without indefinite metric, Rev. Math. Phys. SI1 197-211
- [55] Wald, R.M., 1994: *Quantum field theory on curved space-time and black hole dynamics*, University of Chicago Press, Chicago.
- [56] Weinberg, S., 1995: *The quantum theory of fields, vol. I, Foundations*, Cambridge.
- [57] Wightman, A.: oral communication
- [58] Yennie, D., Frautschi, S. and Suura, H. 1961: The infrared divergence phenomena and high-energy processes Ann. Phys., 13 379-452.