

On the Complexity of the Misère Version of Three Games Played on Graphs.

Gabriel Renault*, Simon Schmidt ‡

June 20, 2018

Abstract

We investigate the complexity of finding a winning strategy for the misère version of three games played on graphs: two variants of the game NIMG, introduced by Stockmann in 2004 and the game VERTEX GEOGRAPHY on both directed and undirected graphs. We show that on general graphs those three games are PSPACE-Hard or Complete. For one PSPACE-Hard variant of NIMG, we find an algorithm to compute an effective winning strategy in time $\mathcal{O}(\sqrt{|V(G)|} \cdot |E(G)|)$ when G is a bipartite graph.

Keywords. Combinatorial Games, Complexity, Graphs, Misère.

Short author's biography.

Gabriel Renault recently graduated his PhD entitled “Combinatorial Games on Graphs”. He worked under the supervision of Paul Dorbec and Éric Sopena in the LaBRI team at Bordeaux University.

Simon Schmidt is a PhD student under the supervision of Sylvain Gravier in the Maths à Modeler team at Joseph Fourier's University in Grenoble. He works on combinatorial games played on graphs and on graph parameters defined by games.

*Univ. Bordeaux, LaBRI, UMR5800, F-33400 Talence France
CNRS, LaBRI, UMR5800, F-33400 Talence, France

†Corresponding author. Postal adress: Univ. Grenoble, Institut Fourier, sfr Maths à Modeler, 100 rue des maths, BP 74, 38402 St Martin d'Herès cedex, France. Phone number: +33 4 76 51 46 56. Email: simonschmidt(at)club-internet.fr

‡Both authors are supported by PEPS Misère Grant.

1 Background and definitions

We assume that the reader has some knowledge in combinatorial games theory. Basic definitions can be found in [?]. We only remind that $o^+(G)$ denotes the normal outcome of the game G , whereas $o^-(G)$ denotes the misère outcome. The outcome of a game is \mathcal{P} if the second player has a winning strategy and \mathcal{N} if the first to move can win. Graph theoretical notions used in this paper are standard and according to [?]. When it makes a difference to allow graphs to have loops, this will be pointed out. Complexity notions for games are those defined by Fraenkel in [?].

In this work we study the complexity of computing the misère outcome of three impartial combinatorial games played on graphs or directed graphs. Two of those games are variants of the famous game called Nim, which was solved by Bouton in 1901 [?]. In those variants, introduced by Stockman in [?], the heaps of tokens are placed on the vertices of a graph. Alternately, the players remove some tokens from the current heap and move along the edges of the graph. The order in which these two actions are done during a turn leads to two different games: NIMG-RM, for “Remove then Move” and NIMG-MR, for “Move then Remove”. The game NIMG-RM is played on a graph G together with a function $w : V(G) \rightarrow \mathbb{N}$, called the weight function. For a vertex u , $w(u)$ represents the number of tokens on u . This game is played as follows:

- There is a pointer on the starting vertex.
- The two players play alternately.
- During his turn, a player removes any number of tokens from the pointed vertex u , and then moves the pointer to a vertex v in the neighbourhood of u . At least one token must be removed.
- The player who starts his turn on a vertex with null weight loses in normal convention and wins in misère convention.

We denote by (G, u, w) the game played on the graph G , with u as starting vertex and w as weight function. We also denote by (u, k, v) the move consisting in decreasing $w(u)$ to $k < w(u)$ and then moving to the vertex v .

The game NIMG-MR is exactly the same game as above, except that the player starts his turn by moving the pointer and then removes tokens from the pointed vertex. If a player is forced to move to a null weight vertex, he loses in normal convention and wins in misère convention.

We denote by (G, u, w) the game played on the graph G , with u as starting vertex and w as weight function. We also denote by (u, k, v) the move

consisting in moving from the vertex u to the vertex v and then decreasing $w(v)$ to $k < w(v)$.

Example Figure 1 gives an example of a move in NIMG-RM. The current vertex is grey. The player whose turn it is chooses to remove two tokens from the current vertex and to move to the vertex with one token. Figure 2 gives an example of a move in NIMG-MR. The current vertex is grey. The player whose turn it is starts by moving the current vertex to the vertex on its right. Then he removes all the tokens from this vertex.

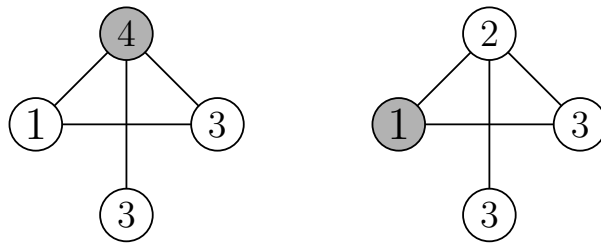

Figure 1: Playing a move in NIMG-RM

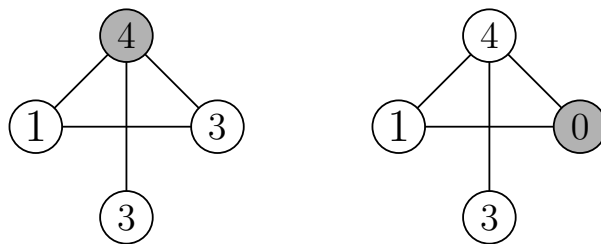

Figure 2: Playing a move in NIMG-MR

The third game we focus on is called GEOGRAPHY. GEOGRAPHY is an impartial game played on a directed graph with a token on a vertex. There exist two variants of the game: VERTEX GEOGRAPHY and EDGE GEOGRAPHY. A move in VERTEX GEOGRAPHY is to slide the token through an arc and delete the vertex on which the token was. A move in EDGE GEOGRAPHY is to slide the token through an arc and delete the edge on

which the token just slid. In both variants, the game ends when the token is on a sink.

A position is described by a graph and a vertex indicating where the token is.

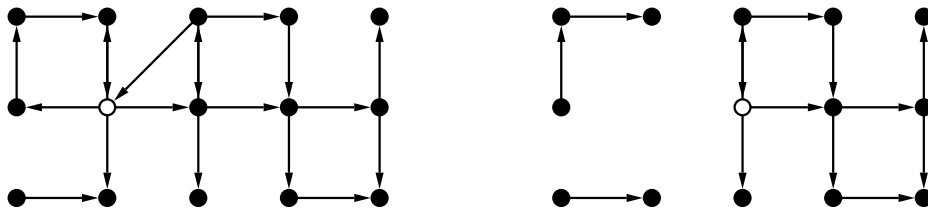

Figure 3: Playing a move in VERTEX GEOGRAPHY

Example Figure 3 gives an example of a move in VERTEX GEOGRAPHY. The token is on the white vertex. The player whose turn it is chooses to move the token through the arc to the right. After the removing of this vertex, some vertices (on the left of the directed graph) are no longer reachable. Figure 4 gives an example of a move in EDGE GEOGRAPHY. The token is on the white vertex. The player whose turn it is chooses to move the token through the arc to the right. After that move, it is possible to go back to the previous vertex immediately as the arc in the other direction is still in the game.

GEOGRAPHY can also be played on an undirected graph G by seeing it as a symmetric directed graph where the vertex set remains the same and the arc set is $\{(u, v), (v, u) | (u, v) \in E(G)\}$, except that in the case of EDGE GEOGRAPHY, going through an edge (u, v) would remove both the arc (u, v) and the arc (v, u) of the directed version, to leave an undirected graph.

A GEOGRAPHY position is denoted (G, u) where G is the graph, or the directed graph, on which the game is played, and u is the vertex of G where the token is.

The complexity of computing the normal outcome of these three games was already known. Burke and George[?] proved that the game NIMG-MR is PSPACE-Hard in normal convention, whereas Duchêne and Renault[?] found that NIMG-RM is solvable in polynomial time. Lichtenstein and Sipser[?] proved that finding the normal outcome of a VERTEX GEOGRAPHY position

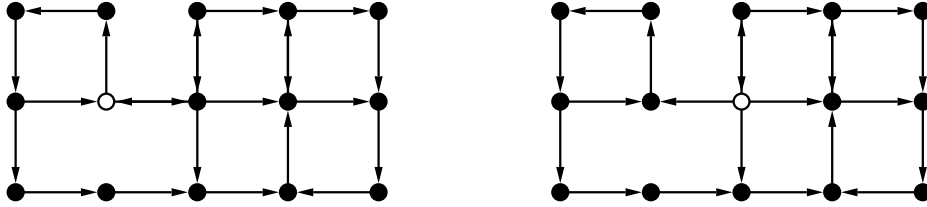

Figure 4: Playing a move in EDGE GEOGRAPHY

on a directed graph is PSPACE-complete. Schaefer[?] proved that finding the normal outcome of an EDGE GEOGRAPHY position on a directed graph is PSPACE-complete. On the other hand, Fraenkel, Scheinerman and Ullman[?] gave a polynomial-time algorithm for finding the normal outcome of a VERTEX GEOGRAPHY position on any undirected graph, and they also proved that finding the normal outcome of an EDGE GEOGRAPHY position on an undirected graph is PSPACE-complete.

In this paper, we extend the investigation to their misère version. The second section is devoted to GEOGRAPHY, and the third section to NIMG.

2 Complexity results for Geography in misère convention

We look here at the game GEOGRAPHY under misère convention, and show the problem is PSPACE-complete both on directed graphs and on undirected graphs, for both VERTEX GEOGRAPHY and EDGE GEOGRAPHY.

We recall all the results in the table below. The stars indicate the results we show here.

First note that all these problems are in PSPACE as the length of a game of VERTEX GEOGRAPHY is bounded by the number of its vertices, and the length of a game of EDGE GEOGRAPHY is bounded by the number of its edges.

We start with VERTEX GEOGRAPHY on directed graphs, where the reduction is quite natural, we just add a losing move to every position of the previous graph, move that the players will avoid until it becomes the only available move, that is when the original game will over.

	EDGE GEOGRAPHY	VERTEX GEOGRAPHY
Normal	PSPACE-complete	PSPACE-complete
Misere	PSPACE-complete (*)	PSPACE-complete (*)

Table 1: Complexity of GEOGRAPHY on directed graph.

	EDGE GEOGRAPHY	VERTEX GEOGRAPHY
Normal	PSPACE-complete	Polynomial
Misere	PSPACE-complete (*)	PSPACE-complete (*)

Table 2: Complexity of GEOGRAPHY on undirected graph.

Theorem 2.1. *Finding the misère outcome of a VERTEX GEOGRAPHY position on a directed graph is PSPACE-complete.*

Proof. We reduce the problem from normal VERTEX GEOGRAPHY on directed graphs.

Let G be a directed graph. Let G' be the directed graph with vertex set

$$V(G') = \{u_1, u_2 | u \in V(G)\}$$

and arc set

$$A(G') = \{(u_1, v_1) | (u, v) \in A(G)\} \cup \{(u_1, u_2) | u \in V(G)\}$$

that is the graph where each vertex of G gets one extra out-neighbour that was not originally in the graph. We claim that the normal outcome of (G, v) is the same as the misère outcome of (G', v_1) and show it by induction on the number of vertices in G .

If $V(G) = \{v\}$, then both (G, v) and (G', v_1) are \mathcal{P} -positions. Assume now $|V(G)| \geq 2$. Assume first (G, v) is an \mathcal{N} -position. There is a winning move in (G, v) to (\tilde{G}, u) . We show that moving from (G', v_1) to (\hat{G}', u_1) is a winning move. We have $V(\hat{G}') = V(\tilde{G}') \cup \{v_2\}$ and $A(\hat{G}') = A(\tilde{G}')$. As the vertex v_2 is disconnected from the vertex u_1 in \hat{G}' , the games (\hat{G}', u_1) and (\tilde{G}', u_1) share the same game tree, and they both have outcome \mathcal{P} by induction. Hence (G', v_1) has misère outcome \mathcal{N} . Now assume (G, v) is a \mathcal{P} -position. For the same reason as above, moving from (G', v_1) to any (\hat{G}', u_1) would leave a game whose misère outcome is the same as the normal outcome of a game obtained after playing a move in (G, v) , which is \mathcal{N} . The only other available move is from (G', v_1) to (\hat{G}', v_2) , which is a losing move as it ends the game. Hence (G', v_1) has misère outcome \mathcal{P} . \square

The proof in [?] actually works even if we only consider planar bipartite directed graphs with maximum degree 3. As our reduction keeps the planarity and the bipartition, only adds vertices of degree 1 and increases the degree of vertices by 1, we get the following corollary.

Corollary 2.2. *Finding the misère outcome of a VERTEX GEOGRAPHY position on a planar bipartite directed graph with maximum degree 4 is PSPACE-complete.*

For undirected graphs, adding a new neighbour to each vertex would work the same, but the normal version of VERTEX GEOGRAPHY on undirected graphs is solvable in polynomial time, so we make a reduction from directed graphs, and replace each arc by an undirected gadget. That gadget would need to act like an arc, that is a player who would want to take it in the wrong direction would lose the game, as well as a player who would want to take it when the vertex at the other end has already been played. We want also to force that the player who moves in the gadget is the same as the one who moves the token to the other end. In that way, it will be the other player's turn when the token reaches the end vertex of the arc gadget, as in the original game.

Theorem 2.3. *Finding the misère outcome of a VERTEX GEOGRAPHY position on an undirected graph is PSPACE-complete.*

Proof. We reduce the problem from normal VERTEX GEOGRAPHY on directed graphs.

We introduce a gadget that will replace any arc (u, v) of the original directed graph, and add a neighbour to each vertex to have an undirected graph whose misère outcome is the normal outcome of the original directed graph.

Let G be a directed graph. Let G' be the undirected graph with vertex set

$$V(G') = \{u, u' \mid u \in V(G)\} \cup \{uv_i \mid (u, v) \in A(G), 1 \leq i \leq 8\}$$

and edge set

$$E(G') = \{(u, uv_1), (uv_1, uv_2), (uv_1, uv_3), (uv_1, uv_6), (uv_2, uv_4), (uv_3, uv_5), (uv_3, uv_6), (uv_4, uv_5), (uv_4, uv_6), (uv_5, uv_6), (uv_6, uv_7), (uv_7, uv_8), (uv_7, v) \mid (u, v) \in A(G)\} \cup \{(u, u') \mid u \in V(G)\}$$

that is the graph where every arc (u, v) of G has been replaced by the gadget of Figure 5, identifying both u vertices and both v vertices, and each vertex

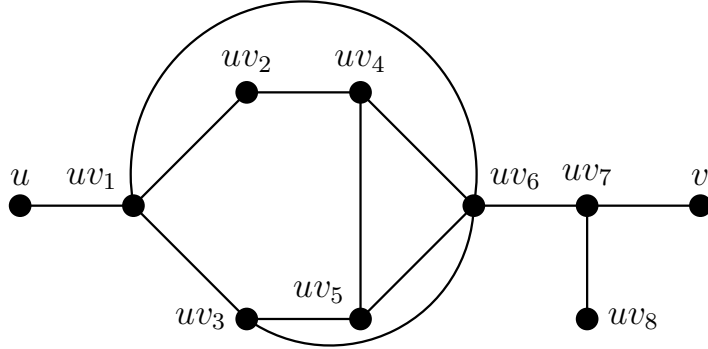

Figure 5: The arc gadget

of G gets one extra neighbour that was not originally in the graph. We claim that the normal outcome of (G, u) is the same as the misère outcome of (G', u) and show it by induction on the number of vertices in G .

If $V(G) = u$, then (G, u) is a normal \mathcal{P} -position. In (G', u) the first player can only move to (\widehat{G}', u') where the second player wins as he cannot move.

Now assume $|V(G)| \geq 2$.

We first show that no player wants to move the token from v to any wv_7 , whether w has been played or not. We will only prove it for moving the token from v to some wv_7 where w is still in the game, as the other case is similar. First note that, if w is removed from the game in the sequence of moves following that first move, as v is already removed, all vertices of the form wv_i would be disconnected from the token, and therefore unreachable. Hence whether the move from wv_1 to w is winning does not depend on the set of vertices deleted in that sequence, and it is possible to argue the two cases. Assume the first player moved the token from v to any wv_7 . Then the second player can move the token to wv_6 . From there, the first player has four choices. If she goes to wv_1 , the second player answers to wv_2 , then the rest of the game is forced and the second player wins. If she goes to wv_4 , he answers to wv_2 where she can only move to wv_1 , and let him go to wv_3 where she is forced to play to wv_5 and she loses. The case where she goes to wv_5 is similar. In the case where she goes to wv_3 , we argue two cases: if the move from wv_1 to w is winning, he answers to wv_5 , where all is forced until he gets the move to w ; if that move is losing, he answers to wv_1 , from where she can either go to w , which is a losing move by assumption, or go to wv_2 where every move is forced until she loses.

We now show that no player wants to move the token from v to any wv_1 where w has already been played. Assume the first player just played that

move. Then the second player can move the token to vw_3 . From there, the first player has two choices. If she plays to vw_6 , he answers to vw_4 , where she can only end the game and lose. If she plays to vw_5 , he answers to vw_4 , where the move to vw_2 is immediately losing, and the move to vw_6 forces the token to go to vw_7 and then to vw_8 , where she loses.

Assume first that (G, u) is an \mathcal{N} -position. There is a winning move in (G, u) to some (\tilde{G}, v) . We show that moving the token from u to uv_1 in G' is a winning move for the first player. From there, the second player has three choices. If he moves the token to uv_6 , the first player answers to uv_3 , then the rest of the game is forced and the first player wins. If he moves the token to uv_2 , the first player answers to uv_4 , where the second player again has two choices: either he goes to uv_6 , she answers to uv_5 where he is forced to lose by going to uv_3 ; or he goes to uv_5 , she answers to uv_6 where the move to uv_3 is immediately losing and the move to uv_7 is answered to a game (\hat{G}', v) . As u' and all vertices of the form uv_i are either played or disconnected from v in \hat{G}' , the only differences in the possible moves in (followers of) the games (\hat{G}', v) and (\tilde{G}', v) are moves from a vertex w to wu_1 or to wu_7 , so they both have outcome \mathcal{P} by induction. The case where he chooses to move the token to uv_3 is similar. Hence (G', u) is an \mathcal{N} -position.

Now assume (G, u) is a \mathcal{P} -position. Then any (\tilde{G}, v) that can be obtained after a move from (G, u) is an \mathcal{N} -position. Moving the token to u' in G' is immediately losing, so we may assume the first player moves it to some uv_1 , where the second player answers to uv_3 . From there the first player has two choices. If she goes to uv_6 , the second player answers by going to uv_4 , where both available moves are immediately losing. If she goes to uv_5 , he answers to uv_4 , where the move to uv_2 is immediately losing, and the move to uv_6 is answered to uv_7 , where again the move to uv_8 is immediately losing, so we may assume he moves the token to v . As u' and all vertices of the form uv_i are either played or disconnected from v in \hat{G}' , the only differences in the possible moves in (followers of) the games (\hat{G}', v) and (\tilde{G}', v) are moves from a vertex w to wu_1 or to wu_7 , so they both have outcome \mathcal{N} by induction. Hence (G', u) is a \mathcal{P} -position. \square

Again, using the fact that the proof in [?] actually works even if we only consider planar bipartite directed graphs with maximum degree 3, as our reduction keeps the planarity since the gadget is planar with the vertices we link to the rest of the graph being on the same face, only adds vertices of degree at most 5 and increases the degree of vertices by 1, we get the following corollary.

Corollary 2.4. *Finding the misère outcome of a VERTEX GEOGRAPHY position on a planar undirected graph with degree at most 5 is PSPACE-complete.*

Though misère play is generally considered harder to solve than normal play, the feature that makes it hard is the fact that disjunctive sums do not behave as nicely as in normal play, and GEOGRAPHY is a game that does not split into sums. Hence the above result appears a bit surprising as it was not expected.

We now look at EDGE GEOGRAPHY where the reductions are very similar to the one for VERTEX GEOGRAPHY on directed graphs.

We start with the undirected version.

Theorem 2.5. *Finding the misère outcome of an EDGE GEOGRAPHY position on an undirected graph is PSPACE-complete.*

Proof. We reduce the problem from normal EDGE GEOGRAPHY on undirected graphs.

Let G be an undirected graph. Let G' be the undirected graph with vertex set

$$V(G') = \{u_1, u_2 | u \in V(G)\}$$

and edge set

$$E(G') = \{(u_1, v_1) | (u, v) \in E(G)\} \cup \{(u_1, u_2) | u \in V(G)\}$$

that is the graph where each vertex of G gets one extra neighbour that was not originally in the graph. We claim that the normal outcome of (G, v) is the same as the misère outcome of (G', v_1) and show it by induction on the number of vertices in G . The proof is similar to the proof of Theorem 2.1 \square

We now look at EDGE GEOGRAPHY on directed graphs.

Theorem 2.6. *Finding the misère outcome of an EDGE GEOGRAPHY position on a directed graph is PSPACE-complete.*

Proof. We reduce the problem from normal EDGE GEOGRAPHY on directed graphs.

Let G be a directed graph. Let G' be the directed graph with vertex set

$$V(G') = \{u_1, u_2 | u \in V(G)\}$$

and arc set

$$A(G') = \{(u_1, v_1) | (u, v) \in A(G)\} \cup \{(u_1, u_2) | u \in V(G)\}$$

that is the graph where each vertex of G gets one extra out-neighbour that was not originally in the graph. We claim that the normal outcome of (G, v) is the same as the misère outcome of (G', v_1) and show it by induction on the number of vertices in G . The proof is similar to the proof of Theorem 2.1 \square

3 Complexity results for NimG in misère convention

In this section, we answer a question from Duchene and Renault. In [?], they found a polynomial algorithm to compute the normal outcome of the game NIMG-RM and asked if there is one in misère convention. We will show that the misère version of NIMG-RM is PSPACE-Hard on general graphs. Our proof, like Burke and George’s proof, used a reduction from the game VERTEX GEOGRAPHY, which is PSPACE-Complete (see section 2). But if we only consider the game on bipartite graphs, we get an algorithm to find an effective strategy in time $\mathcal{O}(\sqrt{|V(G)|} \cdot |E(G)|)$. We also show that NIMG-MR is PSPACE-Hard in misère convention.

We start with a summary of the known results in the two tables below. The stars indicate the new results we prove in this paper. Because loops may sometimes make a difference, we note +L when there is a loop on all the vertices, and +NL when loops are not permitted. As said in the introduction, the results for the polynomial complexity of NIMG-RM in normal play are due to Renault and Duchene [?], whereas the PSPACE-Hardness results for NIMG-MR are due to Burke and George [?].

	NIMG-RM+L	NIMG-RM	NIMG-RM+NL
Normal	Polynomial	Polynomial	Polynomial
Misère	Polynomial (*)	PSPACE-Hard (*)	PSPACE-Hard (*)

Table 3: Complexity of NIMG-RM.

	NIMG-MR+L	NIMG-MR	NIMG-MR+NL
Normal	PSPACE-Hard	PSPACE-Hard	PSPACE-Hard
Misère	PSPACE-Hard (*)	PSPACE-Hard (*)	PSPACE-Hard (*)

Table 4: Complexity of NIMG-MR.

We start with the proof that the misère version of NIMG-RM+NL is PSPACE-Hard on general graphs. We reduce the normal version of VERTEX GEOGRAPHY on directed graphs to the misère version of NIMG-RM+NL. When a vertex with only one token is visited in NIMG-RM, its weight is necessarily decreased to 0. Since in misère convention, moving to a null weight vertex is a losing move, no player wants to move further to this vertex. Decreasing the weight function to 0 in NIMG-RM+NL is therefore convenient to simulate the clear of a vertex in VERTEX GEOGRAPHY. Like in theorem 2.5, the key of the proof is the design of a gadget that acts like an oriented edge.

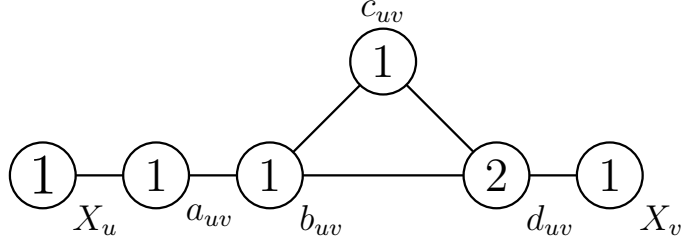

Figure 6: The arc gadget

Theorem 3.1. *The misère version of NIMG-RM+NL is PSPACE-Hard.*

Proof. We perform our reduction as follows. Let G be a directed graph standing for an instance of VERTEX GEOGRAPHY. We construct an undirected graph G' and a weight function $w_{G'}$ as follows:

- If $u \in V(G)$, X_u is a vertex of G' .
- If $u, v \in V(G)$ and $(u, v) \in E(G)$, then $a_{uv}, b_{uv}, c_{uv}, d_{uv}$ are vertices of G' .
- If $(u, v) \in E(G)$, then $(X_u, a_{uv}), (a_{uv}, b_{uv}), (b_{uv}, c_{uv}), (b_{uv}, d_{uv}), (c_{uv}, d_{uv})$ and (d_{uv}, X_v) are undirected edges of G' .
- The weight function is defined by $w_{G'}(X_u) = 1$ and (forgetting the index) $w_{G'}(a) = w_{G'}(b) = w_{G'}(c) = 1$ and $w_{G'}(d) = 2$.

This means we replace all the arcs (u, v) by the gadget of figure 6.

We show by induction on $|V(G)|$ that for each vertex $u \in V(G)$, $o^+((G, u)) = o^-((G', X_u, w))$. If $|V(G)| = 1$ then $o^+((G, u)) = \mathcal{P}$. The graph G' is also reduced to a unique vertex X_0 . The first player has to finish the game by taking the only token on X_u . Hence $o^-((G', X_u, w)) = \mathcal{P}$.

Now assume $|V(G)| \geq 2$. First assume $o^+((G, u)) = \mathcal{N}$. There is a vertex $v \in V(G)$ such that moving toward v is winning. Let \widehat{G} be the subgraph induced by $V(G) \setminus \{u\}$. We have $o^+((\widehat{G}, v)) = \mathcal{P}$. We prove that the first player wins $(G', X_u, w_{G'})$ with the move $(X_u, 0, a_{uv})$. After such a move, the second player is forced to play $(a, 0, b)$ and the first player answers with $(b, 0, c)$. Once again the second player has no choice, he plays $(c, 0, d)$. The first player plays $(d, 0, X_v)$, then the second player has to play in a graph \widetilde{G} . Note that if the first player had played $(b, 0, d)$, she would have lost. In other words the gadget works as an arc. The player who goes inside the gadget is not the one who goes outside. This shows that playing a move of the form $(X_w, 0, a_{wu})$ is always losing because your opponent will have to start one of his further move on X_u and $w(X_u)$ is now equal to 0. Playing a move of the form $(X_w, 0, d_{uw})$ would also be losing as we prove in the second part. Hence,

we have $o^-((\widehat{G}', X_v, w_{\widehat{G}'})) = o^-((\widetilde{G}, X_v, w_{\widetilde{G}}))$ and by induction hypothesis $o^+((\widehat{G}, v)) = o^-((\widehat{G}', X_v, w_{\widehat{G}'})) = \mathcal{P}$. Therefore $(X_u, 0, a)$ is winning and $o^-((G', X_u, w_{G'})) = \mathcal{N}$.

Reciprocally, assume that $o^-((G', X_u, w_{G'})) = \mathcal{N}$. There must exist a winning move. We first show that this move cannot be of the kind $(X_u, 0, d_{vu})$. In other words, we show that our gadget is oriented. We note that the status of the move $(a_{vu}, 0, X_v)$ does not depend of the moves which will be played in the gadget before we reach a_{vu} . In fact, since $w(X_u)$ is now equal to 0, the players will not be able to come back in the gadget after they get out of it. We can therefore work case by case to show that $(X_u, 0, d_{vu})$ is a losing move.

If the move $(a_{vu}, 0, X_v)$ is a losing move, the second player wins with the move $(d_{vu}, 0, c_{vu})$. In fact, the first player has to play $(c_{vu}, 0, b_{vu})$ and he answers with $(b_{vu}, 0, a_{vu})$. Finally, the first player has to play the losing move, $(a_{vu}, 0, X_v)$.

On the other hand, if the move $(a_{vu}, 0, X_v)$ is a winning move, the second player wins with the move $(d_{vu}, 1, b_{vu})$. There are now three possibilities for the first player. She can answer with $(b_{vu}, 0, d_{vu})$. Then the second player plays $(d_{vu}, 0, c_{vu})$ and she has to play $(c_{vu}, 0, b_{vu})$. In that case, the second player wins since we are under misère convention and he is on a null weight vertex. If she chooses to play $(b_{vu}, 0, a_{vu})$, then the second player can play the winning move $(a_{vu}, 0, X_v)$. Finally, if she plays $(b_{vu}, 0, c_{vu})$, the second player answers with $(c_{vu}, 0, d_{vu})$ and she loses because she is now surrounded by null weight vertices.

Since there is no winning move of the kind $(X_u, 0, d_{vu})$, there must be one winning move of the form $(X_u, 0, a_{uz})$. Let \widehat{G} be the subgraph induced by $V(G) \setminus \{u\}$. We focus on the moves following $(X_u, 0, a_{uz})$. The second player has no choice and plays $(a_{uz}, 0, b_{uz})$. Then the first player has two choices. She can move to the vertex d_{uz} . But in this case, the second player will win with $(d_{uz}, 0, c_{uz})$. So we can assume she rather plays to c_{uz} . Her opponent has no choice and move to d_{uz} . Once again she has two choices. The move $(d_{uz}, 1, X_z)$ is losing because the second player can answer with $(X_w, 0, d_{uz})$. Hence we can suppose she plays $(d_{uz}, 0, X_z)$. Since there is no more token on X_u and X_z , the second player has to play in a graph whose outcome is the same as $(\widehat{G}', X_z, w_{\widehat{G}'})$. The outcome of this game is \mathcal{P} because $(X_u, 0, a_{uz})$ is a winning move. By induction hypothesis, $o^+((\widehat{G}, z)) = \mathcal{P}$. So moving to z is a winning move in G and $o^+((G, u)) = \mathcal{N}$. \square

As in the case of the normal version of NIMG-MR (see [?]), the reduction works even if we restrict ourselves to weight functions bounded by 2.

Corollary 3.2. *The misère version of NIMG-RM+NL with weight function bounded by 2 is PSPACE-complete.*

Proof. In this case the length of a game never exceeds $2 \times |V(G)|$ moves. Hence the game is in PSPACE. \square

As recalled in Corollary 2.2 and 2.4, VERTEX GEOGRAPHY is PSPACE-complete even on planar directed graphs with maximum degree 3. Our gadget has both properties. Furthermore, the reduction does not increase the degree of the original graph vertices, so we get the following result.

Corollary 3.3. *The misère version of NIMG-RM+NL with weight function bounded by 2 is PSPACE-complete even when restricted to planar graphs with degree at most 3.*

The previous reduction raises up two questions. Does NIMG-RM+NL remain PSPACE-Hard if we bound the weight function by 1? And is it still PSPACE-Hard if we only consider bipartite graphs? In fact, the odd cycle and the vertex with two tokens seem essential to perform our reduction to NIMG-RM+NL. The two results below show that they are really necessary.

Theorem 3.4. *Let G be a graph and w its weight function. If w is constant equal to 1, we can compute $o^-(G, u, w)$ and find an effective winning strategy in time $\mathcal{O}(\sqrt{|V(G)|} \cdot |E(G)|)$.*

Proof. If we allow only one token by vertices, the misère version of NIMG-RM+NL is exactly the same as the normal version of VERTEX GEOGRAPHY on undirected graphs. As recalled in the table of Section 2, this game is solvable in polynomial time. Therefore, with only one token allowed, the misère version of NIMG-RM+NL is also solvable in polynomial time. \square

In the next theorem and its corollary, we prove that the problem is also solvable in polynomial time when we play on bipartite graphs. We will assume there is no null weight vertex at the beginning. It is not really a restriction, since in misère version, the outcome of the game is the same if we played on a graph G or on the subgraph of G induced by the vertices with at least one token.

Theorem 3.5. *Let G be a bipartite graph and w a strictly positive weight function. The position (G, u, w) of NIMG-RM+NL is winning in misère convention if and only if all the maximum matchings of G cover the starting vertex u .*

Proof. Since G is bipartite, we can split $V(G)$ into two disconnected subsets L and R such that $u \in L$. Note that the first player will always remove tokens from vertices of L whereas his opponent will remove tokens from R .

We now assume that all the maximum matchings of G cover u . Let M be such a matching. We show that removing all the heaps on the current vertex and then moving along an edge of M is a winning strategy for the first player. We look at the first time she cannot follow the above strategy. There are two possibilities. Firstly, she is on a vertex with no token on it. In this case, she wins and the strategy is indeed a winning one. The second possibility is that she is on a vertex not visited before but uncovered by M . We show this possibility never happens. In that case we have a list of edges $(f_1, s_1, \dots, f_n, s_n)$ such that the f_i stands for the edges followed by the first player and the s_i the edges followed by the second one. Since the game is not already ended, the s_i have no vertex in L in common. Otherwise, the first player would have been on a null weight vertex. Hence the f_i which are in M are all distinct and they have no vertex in common either. In other words $(f_1, s_1, \dots, f_n, s_n)$ is a path. So $(M \cup \{s_1, \dots, s_n\}) \setminus \{f_1, \dots, f_n\}$ is a maximum matching which does not cover u . This is in contradiction with our hypothesis.

Reciprocally, assume there is a maximum matching M which does not cover u . Let v be the first vertex toward which the first player moves. Since M is maximum, v is covered by M . Hence the second player can follow the same strategy as we saw above. Showing that this strategy is winning for him can be done as before. The case where he is stuck on a vertex uncovered by M will not appear either. In this case, it actually leads to an augmenting path $(f_1, s_1, \dots, f_n, s_n, f_{n+1})$, which would contradict the maximality of M . \square

Corollary 3.6. *The misère version of the game NIMG-RM+NL is solvable in polynomial time on bipartite graph. Computing $o^-((G, u, w))$ and finding an effective winning strategy can be done in time $\mathcal{O}(\sqrt{|V(G)|} \cdot |E(G)|)$.*

Proof. Let G' be the subgraph induced by $V(G) \setminus \{u\}$. We compute C the cardinal of a maximum matching of G , then we compute C' the cardinal of a maximum matching of G' . Both of these operations can be done in time $\mathcal{O}(\sqrt{|V(G)|} \cdot |E(G)|)$, using the Edmond-Karp's algorithm. If $C = C'$, there is a maximum matching of G which does not cover u , then $o^-((G, u, w)) = \mathcal{P}$. On the contrary, if $C' < C$, all the maximum matchings of G cover u and $o^-((G, u, w)) = \mathcal{N}$. Moreover, the Edmond-Karp's algorithm gives us a maximum matching of G covering u . The effective winning strategy is as follows: take all the tokens on the current vertex, then move along the edge of the matching. \square

To finish with the game NIMG-RM, we give an algorithm for the misère version of NIMG-RM+L. One more time, we suppose there is no null weight vertex at the beginning. We already saw it does not matter.

Theorem 3.7. *Let G be a graph with a loop on all its vertices and w its weight function. Computing $o^-((G, u, w))$ and finding an effective winning strategy can be done in time $\mathcal{O}(\sqrt{|V(G)|} \cdot |E(G)|)$.*

Proof. Let T be the subset of $V(G)$ defined by $T = \{u \in V(G) \mid w(u) \geq 2\}$. We show that for any u in T , (G, u, w) is a winning position. Assume there is a winning move of the form $(u, 0, v)$ with $v \neq u$. In this case (G, u, w) is clearly winning. If all the moves of this kind are losing moves, the first player decreases $w(u)$ to 1 and then uses the loop to stay on u . His opponent will have to play one of the losing moves $(u, 0, v)$, so (G, u, w) is also winning in this case.

Now, let u be a vertex with $w(u) = 1$ and let C_u be the connected component of $G \setminus T$ which contains u . Since moving outside C_u is always a losing move, we have $o^-((G, u, w)) = o^-((C_u, u, w))$. Using theorem 3.4 we can compute $o^-((C_u, u, w))$ in the expected time. \square

We conclude this section with the result for NIMG-MR in misère convention. For our result, the loops do not matter, so we forget the +L and +NL. Burke and George only proved in [?] that NIMG-MR+L is PSPACE-Hard in normal convention. Carefully looking at their proof, it turns out that it works the same for NIMG-MR+NL in normal convention. To get our result, we reduce the normal version of NIMG-MR to its misère version.

Theorem 3.8. *The game NIMG-MR+L and the game NIMG-MR+NL are PSPACE-Hard in misère convention.*

Proof. Let G be a graph. We construct the graph G' by adding to each vertex of G a chain of three vertices with weight 1 (see figure 7). We claim that $o^+(G) = o^-(G')$, because when you play on G' , moving outside G is always a losing move. The details of the proof are similar to theorem 2.1. \square

4 Conclusion.

In this work, we made a comprehensive study of the complexity of the misère version of the three games GEOGRAPHY, NIMG-RM and NIMG-MR. Except for the variant of NIMG-RM with a loop on each vertex, all these games are PSPACE-hard or complete on general graphs. This shows that the misère

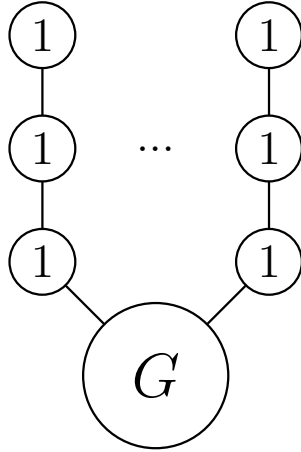

Figure 7: Reduction from the normal version to the misère one

versions of those games are never easier than the normal ones. For NIMG-RM+NL and VERTEX GEOGRAPHY on undirected graphs there is even a real gap between the normal and the misère version, since an effective winning strategy can be computed in polynomial time under normal play.

Our reductions for VERTEX GEOGRAPHY on undirected graphs, NIMG-RM and NIMG-MR made an intensive use of odd cycles. Hence we investigated the restriction of those games to bipartite graphs. For NIMG-RM, we showed that the game becomes polynomial in that case, whereas for VERTEX GEOGRAPHY and NIMG-MR the complexity is still unknown.

5 Acknowledgements.

We thank Sylvain Gravier for the helpful discussions we had together all along this work.