

Non-Supersymmetric Magic Theories and Ehlers Truncations

Alessio Marrani^{1,2}, Gianfranco Pradisi³, Fabio Riccioni⁴, Luca Romano⁵

¹*Museo Storico della Fisica e Centro Studi e Ricerche “Enrico Fermi”
Via Panisperna 89A, I-00184, Roma, Italy*

²*Dipartimento di Fisica e Astronomia, Università di Padova,
and INFN, Sez. di Padova,
Via Marzolo 8, I-35131, Padova, Italy*

³*Dipartimento di Fisica, Università di Roma “Tor Vergata”,
and INFN, Sez. di Roma “Tor Vergata”
Via della Ricerca Scientifica 1, I-00133 Roma, Italy*

⁴*INFN Sezione di Roma, Dipartimento di Fisica, Università di Roma “La Sapienza”,
Piazzale Aldo Moro 2, I-00185 Roma, Italy*

⁵*Riemann Center for Geometry and Physics
Leibniz Universitaet Hannover
Appelstrasse 2, D-30167 Hannover, Germany*

email addresses: alessio.marrani@pd.infn.it, Gianfranco.Pradisi@roma2.infn.it,
Fabio.Riccioni@roma1.infn.it, lucaromano2607@gmail.com

ABSTRACT

We consider the non-supersymmetric “magic” theories based on the split quaternion and the split complex division algebras. We show that these theories arise as “Ehlers” $SL(2, \mathbb{R})$ and $SL(3, \mathbb{R})$ truncations of the maximal supergravity theory, exploiting techniques related to very-extended Kac-Moody algebras. We also generalise the procedure to other $SL(n, \mathbb{R})$ truncations, resulting in additional classes of non-supersymmetric theories, as well as to truncations of non-maximal theories. Finally, we discuss duality orbits of extremal black-hole solutions in some of these non-supersymmetric theories.

Contents

1	Introduction	1
2	Non-supersymmetric theories based on \mathbb{C}_s and \mathbb{H}_s	5
3	Ehlers $SL(n, \mathbb{R})$ truncations of maximal supergravity in any dimension	11
4	Ehlers $SL(n, \mathbb{R})$ truncations: non-maximal cases	17
5	Black holes and duality orbits	22
6	Discussion and conclusions	28

1 Introduction

Supergravity theories possess hidden global symmetries that turn out to be much larger than those expected from the geometry of the compactification space. For instance, maximal supergravities in $D \geq 3$ exhibit an $E_{11-D(11-D)}$ [1,2] global symmetry, to be compared with the $GL(11-D, \mathbb{R})$ group related to the isometries of the $(11-D)$ -dimensional torus. Extra symmetries, of course, are not necessarily symmetries of the full Lagrangian, but they leave the field equations invariant. In relation to string theory, it is conjectured [3] that the full non-perturbative string models are invariant only under discrete subgroups of the global symmetries of the corresponding low-energy supergravity theories. Such discrete symmetries are usually termed U-dualities, and they play a crucial role in understanding the deep relations between different perturbative string theories, that are mapped under their action one to the other in diverse regions of the moduli space [4]. Hidden global symmetries are also useful in determining all possible massive deformations of a given ungauged supergravity. Indeed, the embedding tensor [5–9] singles out the allowed gauge groups inside the global symmetry group, providing a covariant description of all possible gaugings of a given supergravity theory.

The maximal supergravity theories in any dimension are related to the very-extended Kac-Moody algebra $E_{8(8)}^{+++}$ (also called E_{11}) [10], whose Dynkin diagram is reported in fig. 1. The maximal theory in dimension D corresponds to the decomposition of the

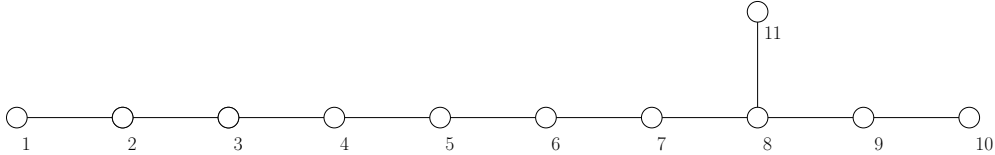

Figure 1: The $E_{8(8)}^{+++}$ Dynkin diagram.

algebra in which the “gravity line” is identified with the A_{D-1} subalgebra containing node 1, while the part of the diagram that is not connected to the A_{D-1} subalgebra corresponds to the internal symmetry. From the diagram one then sees that the highest dimension to which the theory can be uplifted is 11, while there are two different theories in ten dimensions, namely the IIA theory (with A_9 given by nodes from 1 to 9) and the IIB theory (with A_9 given by nodes from 1 to 8 plus node 11) [11]. Decomposing the adjoint representation of $E_{8(8)}^{+++}$ in any dimension one obtains all the p -forms of the theory. This not only includes all the propagating fields and their duals, but also $(D-1)$ -forms and D -forms. The $(D-1)$ -forms are dual to the massive/gauge deformations, while the D -forms are related to space-filling branes. In particular, in the IIA case one obtains an 8-form which is dual to the Romans mass [12], and generalising this analysis to any dimension one discovers [13,14] that the $(D-1)$ -forms predicted in D dimensions by $E_{8(8)}^{+++}$ precisely correspond to the representations of the embedding tensor derived in [5–9]. All the p -forms with the corresponding representations for the maximal supergravities are reported in Table 1 (taken from [13,14]).

The same construction can be extended to 1/2-maximal and symmetric 1/4-maximal

Dim	Symmetry	$p=1$	$p=2$	$p=3$	$p=4$	$p=5$	$p=6$	$p=7$	$p=8$	$p=9$	$p=10$
11	–			1			1				
10A	\mathbb{R}^+	1	1	1		1	1	1	1	1	2×1
10B	$SL(2, \mathbb{R})$		2		1		2		3		$\begin{matrix} 4 \\ 2 \end{matrix}$
9	$GL(2, \mathbb{R})$	$\begin{matrix} 2 \\ 1 \end{matrix}$	2	1	1	2	$\begin{matrix} 2 \\ 1 \end{matrix}$	$\begin{matrix} 3 \\ 1 \end{matrix}$	$\begin{matrix} 3 \\ 2 \end{matrix}$	4	2×2
8	$SL(3, \mathbb{R}) \times SL(2, \mathbb{R})$	$(\bar{3}, 2)$	$(3, 1)$	$(1, 2)$	$(\bar{3}, 1)$	$(3, 2)$	$(8, 1)$ $(1, 3)$	$(6, 2)$ $(\bar{3}, 2)$	$(15, 1)$ $(3, 3)$ $2 \times (3, 1)$		
7	$SL(5, \mathbb{R})$	$\bar{10}$	5	$\bar{5}$	10	24	$\bar{40}$ $\bar{15}$	70 45 5			
6	$SO(5, 5)$	16	10	$\bar{16}$	45	144	$\frac{320}{126}$ 10				
5	$E_{6(6)}$	27	$\bar{27}$	78	351	$\frac{1728}{27}$					
4	$E_{7(7)}$	56	133	912	$\frac{8645}{133}$						
3	$E_{8(8)}$	248	3875 1	$\frac{147250}{3875}$ 248							

Table 1: All the p -forms of the $E_{8(8)}^{+++}$ theory in any dimension.

supergravities where, precisely as in the maximal theory, the Kac-Moody algebra is G_3^{+++} , G_3 being the global symmetry of the three-dimensional theory [15–17]. In particular, the 1/2-maximal theories correspond to the Kac-Moody algebra $SO(8, n)^{+++}$, while among the 1/4-maximal theories one can consider the magic ones [18–21], corresponding to the algebras $F_{4(4)}^{+++}$, $E_{6(2)}^{+++}$, $E_{7(-5)}^{+++}$ and $E_{8(-24)}^{+++}$ [16]. With the exception of the $F_{4(4)}^{+++}$ case, the real form of the symmetry group of these theories is non-split, a fact taken into account by considering the Tits-Satake diagram of G_3^{+++} , which identifies the real form of the global symmetry in any dimension, as well as the highest dimension to which the theory can be uplifted [16].

As shown in [18–21], the exceptional $\mathcal{N} = 2$ Maxwell-Einstein supergravities in $D = 4, 5$ are related to cubic Jordan algebras. In particular, they are based on simple Euclidean Jordan algebras $\mathbf{J}_3^{\mathbb{A}}$ generated by 3×3 Hermitian matrices over the four normed division algebras $\mathbb{A} = \mathbb{R}, \mathbb{C}, \mathbb{H}, \mathbb{O}$. They can be associated to the *single split* version of the famous “magic square” of Freudenthal, Rozenfeld and Tits [22]. For this reason they are called “magic”. The complex and quaternionic theories are consistent $\mathcal{N} = 2$ truncations of the maximal $\mathcal{N} = 8$ supergravity, while the $\mathcal{N} = 2$ octonionic theory is not, as manifested by the fact that in four dimensions it is based on the minimally non-compact real form $E_{7(-25)}$, completely different from the maximally non-compact (split) real form $E_{7(7)}$.

An analogous analysis can be performed by replacing the division algebras with their *split* versions \mathbb{A}_s and the magic square with the *doubly split* magic square [23] (also *cfr.* [24])

	\mathbb{R}	\mathbb{C}_s	\mathbb{H}_s	\mathbb{O}_s
\mathbb{R}	$SO(3)$	$SL(3, \mathbb{R})$	$Sp(6, \mathbb{R})$	$F_{4(4)}$
\mathbb{C}_s	$SL(3, \mathbb{R})$	$SL(3, \mathbb{R}) \times SL(3, \mathbb{R})$	$SL(6, \mathbb{R})$	$E_{6(6)}$
\mathbb{H}_s	$Sp(6, \mathbb{R})$	$SL(6, \mathbb{R})$	$SO(6, 6)$	$E_{7(7)}$
\mathbb{O}_s	$F_{4(4)}$	$E_{6(6)}$	$E_{7(7)}$	$E_{8(8)}$

Table 2: The doubly split magic square [23].

given in Table 2. While the theory based over the split octonions \mathbb{O}_s is the maximal supergravity theory, the theories based on \mathbb{C}_s and \mathbb{H}_s are non-supersymmetric and their field content is a gravitational model not interpretable as the bosonic sector of a locally supersymmetric theory. Exactly as for all the supersymmetric theories discussed above, they correspond to the very-extended Kac-Moody algebras $E_{6(6)}^{+++}$ and $E_{7(7)}^{+++}$. These algebras were originally considered in [25] and, as emerging from their diagram, they can be uplifted at most to eight and ten dimensions, respectively. The spectrum of forms of the $E_{6(6)}^{+++}$ theory in eight dimensions, as well as the one of the $E_{7(7)}^{+++}$ theory in nine and ten dimensions, was listed in [26]. In the same paper it was also shown that these Kac-Moody algebras are consistent truncations of $E_{8(8)}^{+++}$.

It is the main purpose of this paper to further investigate these truncations. In particular, we refer to the analysis of [27], where it is observed that in any supersymmetric theory with scalars parametrising a symmetric manifold, the global symmetry group G_3 in three dimensions can be decomposed in D dimensions factorizing the Ehlers group $SL(D-2, \mathbb{R})$ as

$$G_3 \supset G_D \times SL(D-2, \mathbb{R}) . \quad (1.1)$$

The group on the right-hand side of (1.1) was dubbed “super-Ehlers group” in [27]. In particular, for the maximal theories, one obtains the so-called Cremmer-Julia sequence (*cfr. e.g.* Sec. 1 of [28])

$$E_{8(8)} \supset E_{11-D(11-D)} \times SL(D-2, \mathbb{R}) . \quad (1.2)$$

Within the sequence in eq. (1.2), the $E_{7(7)}$ and $E_{6(6)}$ groups that appear in the fourth column of the doubly split magic square in Table 2 occur as U-duality groups of the maximal supergravity theory in $D=4$ and $D=5$ respectively. Notice that the same groups also occur in the fourth row of the magic square; thus, as mentioned before, the theories based on \mathbb{H}_s and \mathbb{C}_s , that can be obtained by the very-extended Kac-Moody algebras $E_{7(7)}^{+++}$ and $E_{6(6)}^{+++}$, have in three dimensions precisely the symmetry of the maximal theory in four and five dimensions, respectively. The truncation of the $E_{8(8)}^{+++}$ theory that leads to the $E_{7(7)}^{+++}$ and $E_{6(6)}^{+++}$ ones is therefore precisely of Ehlers type. Thus, it is natural to compare the p -form spectra of the $E_{7(7)}^{+++}$ and $E_{6(6)}^{+++}$ algebras in any dimension with those obtained by truncating in any dimensions the representations of the maximal theories (given in Table 1) to singlets of $SL(2, \mathbb{R})$ and $SL(3, \mathbb{R})$. We obtain a perfect match, with the only

exceptions of the multiplicity of the lower-dimensional representations of the D -forms in D dimensions and of the 2-forms in three dimensions, which are typically less than the result of the truncation. We use the software `SimpLie` [14] to determine the spectrum of the theories in any dimension.

Our procedure can be extended to Ehlers $SL(n, \mathbb{R})$ truncations with $n > 3$, giving again theories that in three dimensions have the symmetry of the maximal theory in $n+2$ dimensions. As a consequence, their spectra are given by the Kac-Moody algebras $SO(5, 5)^{+++}$ ($n = 4$), $SL(5, \mathbb{R})^{+++}$ ($n = 5$) and $(SL(3, \mathbb{R}) \times SL(2, \mathbb{R}))^{+++}$ ($n = 6$). While the first two were discussed in [26], the third is the extension of a group which is not simple. The general analysis of Kac-Moody algebras of this type was first considered in [29]. We compare the spectrum of these theories with the Ehlers truncation of the spectrum of the maximal theory in any dimensions, obtaining the same match as for the $n = 2$ and $n = 3$ cases. In particular, one recovers the “split magic triangle” of [30].

An allowed realization of these models within perturbative string theory is possible only if the Ehlers $SL(n, \mathbb{R})$ truncation can be embedded in the perturbative symmetry of the maximal theory, *i.e.* the one that does not act on the string dilaton. We show how this can be directly extracted by an analysis of the Dynkin diagram of the very-extended algebra of the truncated theory. The fact that such Dynkin diagrams encode information about T-duality transformations was originally shown in [26].

The truncation procedure can also be applied in the same fashion to 1/2-maximal and to 1/4-maximal theories. In [31] a large class of symmetric G/H non-linear σ -models has been analysed in $D = 3$ and lifted to $D = 4$. The cosets are non-compact Riemannian symmetric spaces, and some of them correspond to the bosonic sectors of supergravities with sixteen or eight supersymmetries. They can be extended to the possible allowed higher dimensions using again the technique based on the related very-extended Kac-Moody algebras.

For the theories based on \mathbb{H}_s and \mathbb{C}_s , one can use the connection with Jordan algebras to determine the orbits of extremal black hole solutions in four and five dimensions. In [32] the analysis of black-hole orbits of the maximal theory was performed in terms of bound states of the weights of the representations to which the black-hole charges belong. By repeating the same analysis for the representations of the black hole charges of the $E_{6(6)}^{+++}$ and $E_{7(7)}^{+++}$ theories, one obtains not only a perfect match with the Jordan algebra investigation, but also an extension of it to higher dimensions. Following [33], where it was shown how the results of [32] can be extended to non-split groups, one can also determine the orbits of the truncations of the 1/2-maximal and the 1/4-maximal theories.

The paper is organised as follows. In Section 2 we analyse the spectrum of the theories based on the very-extended Kac-Moody algebras $E_{7(7)}^{+++}$ and $E_{6(6)}^{+++}$. We prove that they are consistent truncations of maximal theories (based on $E_{8(8)}^{+++}$) obtained by modding out the corresponding Ehlers group. We also discuss the embeddings within string theory. In Section 3, we extend the class of theories by observing that the duality group in $D = 3$ exactly coincides with that of the Ehlers truncation of the maximal theory in dimension¹ D . In the explained sense, our procedure *gives an alternative definition* of the very-extended

¹As mentioned, at least where exceptional Lie algebras are involved, this is a consequence of the symmetry of the doubly split magic square [23].

duality algebra. When considering non-simple duality algebras, our results coincide with those obtained using the method proposed in [29]. In Section 4, we extend the construction to a large class of theories with less supersymmetry, like the ones discussed in [31], and to the infinite series of orthogonal very-extended algebras, related also to the dimensional reduction of the heterotic string. In Section 5, the analysis of [33] is extended to the black-hole orbits of the models presented in this paper. As obtained in [33], the absence of orbit splitting can be traced back to the lack of short weights in the corresponding representation space. Finally, in Section 6 we discuss the embedding within string theory, and we present our conclusions and discussions about possible future directions.

2 Non-supersymmetric theories based on \mathbb{C}_s and \mathbb{H}_s

The $\mathcal{N} = 2$ “magic” Maxwell-Einstein supergravity theories discovered in [18–20] are based on the simple Euclidean Jordan algebras $\mathbf{J}_3^{\mathbb{A}}$ generated by 3×3 Hermitian matrices over the four normed division algebras $\mathbb{A} = \mathbb{R}, \mathbb{C}, \mathbb{H}, \mathbb{O}$. The symmetry of the theories in dimension from three to five is connected to the single spit form of the famous “magic square” of Freudenthal, Rozenfeld and Tits (*cf.* [22], as well as the recent review on magic squares of order 3 and their relevance in (super)gravity theories [24]). In particular, in three dimensions these theories have global symmetry $F_{4(4)}$, $E_{6(2)}$, $E_{7(-5)}$ and $E_{8(-24)}$, respectively. The relation between these theories and the Jordan algebras $\mathbf{J}_3^{\mathbb{A}}$ was used in [34] (see also [35]) to classify the orbits of all the extremal black-hole solutions in various dimensions. An analogous magic square exists also for the split division algebras $\mathbb{R}, \mathbb{C}_s, \mathbb{H}_s, \mathbb{O}_s$ [23]: with complex parameters, the corresponding groups are the same as those resulting from the division algebras, but they enter now in the split real form. The split-octonion case corresponds to the $E_{8(8)}$ symmetry in three dimensions and therefore the algebra is that associated to maximal supergravity. In this section, we want to consider the remaining theories based on \mathbb{C}_s and \mathbb{H}_s ; in three dimensions, they have a (electric-magnetic) duality² symmetry groups $E_{6(6)}$ and $E_{7(7)}$, respectively.

In [16] it was shown that the bosonic spectrum of the $\mathcal{N} = 2$ magic theories can be derived from the Kac-Moody algebras G^{+++} where G is the symmetry of the three-dimensional theory. The real form of the symmetry group in any dimension is identified by the corresponding Tits-Satake diagram, and the symmetry of the theory in a given dimension is obtained by the deletion of the corresponding node precisely as in the maximal case. The deleted node is in general associated to the global scale symmetry and therefore it must correspond to a non-compact Cartan generator, and while for split real forms one can always take the Cartan generators to be all non-compact, for other real forms this is not the case and the Tits-Satake diagram precisely identifies which Cartan generators are compact and which are non-compact. For the Kac-Moody algebras associated to the $\mathcal{N} = 2$ magic theories, the fact that the nodes of the Tits-Satake diagrams corresponding

²Here duality is referred to as the analogue in a non-supersymmetric context of the “continuous” symmetries of [1, 2], whose discrete versions in the supersymmetric case are the U-dualities of non-perturbative string theory introduced by Hull and Townsend [3].

to compact Cartan generators cannot be deleted explains from this perspective why these theories can only be uplifted at most to six dimensions.

One can consider as an example the theory based on \mathbb{O} , corresponding to the Kac-Moody algebra $E_{8(-24)}^{+++}$, whose Tits-Satake diagram is drawn in fig. 2. Following the

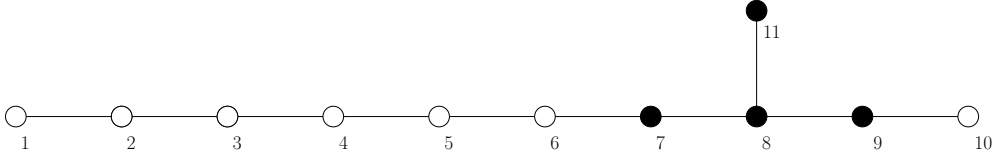

Figure 2: The $E_{8(-24)}^{+++}$ Tits-Satake diagram.

standard convention of Tits-Satake diagrams, the black nodes in fig. 2 are associated to compact Cartan generators. By deleting node 3 one obtains the Tits-Satake diagram of $E_{8(-24)}$, which is the global symmetry of the three-dimensional theory, and by further deleting nodes 4, 5 and 6 one obtains the Tits-Satake diagrams of $E_{7(-25)}$, $E_{6(-26)}$ and $SO(1, 9)$, which are the global symmetries in four, five and six dimensions, respectively. Node 7, corresponding to a compact Cartan generator, cannot be deleted and the theory cannot be uplifted to seven dimensions. The spectrum of the theory, in the dimensions in which it exists, can be read from Table 1, keeping in mind that the reality properties of the various representations differ from those of the maximal theory because the symmetry groups are in different real forms [16]. The same analysis can be performed for the theories based on \mathbb{H} , \mathbb{C} and \mathbb{R} , whose Tits-Satake very-extended diagrams can be found in [16]. It should again be stressed that in all cases the Kac-Moody algebra allows to determine the full spectrum of the theory, including the $(D - 1)$ -forms and the D -forms.

By analogy with the $\mathcal{N} = 2$ case, it is then natural to associate to the theories based on \mathbb{C}_s and \mathbb{H}_s the very-extended Kac-Moody algebras $E_{6(6)}^{+++}$ and $E_{7(7)}^{+++}$ [25, 26]; in this case, the algebra is split and therefore the Tits-Satake diagram coincides with the Dynkin diagram, with all non-compact Cartan generators. From the Kac-Moody algebra, one then determines the spectrum of all forms in any dimension. The highest dimension to which these theories can be uplifted is 10 in the case of $E_{7(7)}^{+++}$ and 8 in the case of $E_{6(6)}^{+++}$.

We start by considering the \mathbb{H}_s -based $E_{7(7)}^{+++}$ theory, whose Dynkin diagram is drawn in fig. 3. From the diagram, it is evident that the theory can be uplifted to $D = 10$ [26]. In-

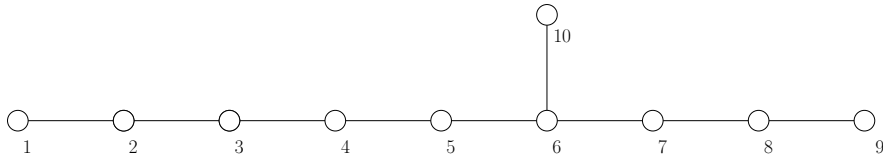

Figure 3: The $E_{7(7)}^{+++}$ Dynkin diagram.

deed, by deleting node 10, one obtains a symmetry $SL(10, \mathbb{R})$ associated to a 10-dimensional theory. From the point of view of the Dynkin diagram, the dimensional reduction corresponds to further deleting the nodes starting from node 9. The D -dimensional theory

Dim	Symmetry	$p = 1$	$p = 2$	$p = 3$	$p = 4$	$p = 5$	$p = 6$	$p = 7$	$p = 8$
10	—				1				
9	\mathbb{R}^+	1		1	1		1	1	
8A	$GL(2, \mathbb{R})$	2	1	2	1	2	3 1	2×2	3 2×1
8B	$SL(3, \mathbb{R})$		3		$\bar{\mathbf{3}}$		8		15 3
7	$GL(3, \mathbb{R})$	3 1	3	$\bar{\mathbf{3}}$	$\bar{\mathbf{3}}$ 1	8 1	8 $\bar{\mathbf{6}}$ 3	15 $\bar{\mathbf{6}}$ 2×3	
6	$SL(4, \mathbb{R}) \times SL(2, \mathbb{R})$	$(\mathbf{4}, \mathbf{2})$	$(\mathbf{6}, \mathbf{1})$	$(\bar{\mathbf{4}}, \mathbf{2})$	$(\mathbf{15}, \mathbf{1})$ $(\mathbf{1}, \mathbf{3})$	$(\bar{\mathbf{20}}, \mathbf{2})$ $(\mathbf{4}, \mathbf{2})$	$(\mathbf{64}, \mathbf{1})$ $(\bar{\mathbf{10}}, \mathbf{3})$ $(\mathbf{6}, \mathbf{3})$ $2 \times (\mathbf{6}, \mathbf{1})$		
5	$SL(6, \mathbb{R})$	15	$\bar{\mathbf{15}}$	35	$\bar{\mathbf{105}}$ 21	384 105 $\bar{\mathbf{15}}$			
4	$SO(6, 6)$	32	66	352	2079 462 66				
3	$E_{7(7)}$	133	1539 1	40755 1539 1					

Table 3: All the p -forms of the $E_{7(7)}^{+++}$ theory in any dimension.

corresponds to an $SL(D, \mathbb{R})$ symmetry in the diagram involving nodes from 1 to $D - 1$, and the nodes that are not connected to any of the $SL(D, \mathbb{R})$ nodes form the global (duality) symmetry group. As already mentioned, the deleted node gives an extra scaling symmetry so that the symmetry associated to the gravity sector is actually $GL(D, \mathbb{R})$, and in the case in which two nodes have to be cancelled, there is an extra \mathbb{R}^+ global symmetry corresponding to the fact that there is an additional internal Cartan generator. Apart from the theories that one obtains from dimensional reduction of the 10-dimensional theory, there is also an 8-dimensional theory whose corresponding $SL(8, \mathbb{R})$ is formed by the nodes from 1 to 6 and node 10. We call this theory 8B, whereas we name the other 8-dimensional theory 8A, in analogy with the maximal case.

In Table 3 we list all the p -forms of the theory in any dimension. These (together with gravity and the scalars, that always parametrise a symmetric manifold G/H , where G is the global symmetry and H is the maximal compact subgroup of G) give the full bosonic spectrum of the theory. In three dimensions, the theory describes 70 scalars, which is the number of bosonic degrees of freedom in any dimension. In ten dimensions, the theory contains only a self-dual 4-form [26]. By looking at Table 1, one can see that such spectrum

arises by truncating the spectrum on the IIB theory to only singlets of $SL(2, \mathbb{R})$. This fact actually generalises to any dimension: the symmetry of the maximal theory G_D in D dimensions decomposes as $SL(2, \mathbb{R}) \times G_D^{(2)}$, where $G_D^{(2)}$ is the D -dimensional symmetry of the $E_{7(7)}^{+++}$ theory. Moreover, the spectrum of the $E_{7(7)}^{+++}$ is obtained by decomposing all representations of the maximal theory as representations of $SL(2, \mathbb{R}) \times G_D^{(2)}$ and keeping only those that are singlets of $SL(2, \mathbb{R})$. This truncation is obviously guaranteed to be consistent.

The fact that the $E_{7(7)}^{+++}$ theory is an $SL(2, \mathbb{R})$ truncation of the $E_{8(8)}^{+++}$ theory actually also explains the occurrence of two different theories (8A and 8B) in eight dimensions. Indeed, the maximal theory in eight dimensions has symmetry $SL(3, \mathbb{R}) \times SL(2, \mathbb{R})$, and thus there are two different ways of factoring out an $SL(2, \mathbb{R})$. In the first case, taking the $SL(2, \mathbb{R})$ inside $SL(3, \mathbb{R})$, one ends up with the theory denoted 8A in the table, which has symmetry $GL(2, \mathbb{R})$ and arises as the torus T^2 -reduction of the ten-dimensional theory. On the other hand, factoring out the other $SL(2, \mathbb{R})$ gives rise to the theory with global symmetry $SL(3, \mathbb{R})$ denoted 8B in the table, which cannot be obtained by dimensional reduction.

We can consider in detail how the truncation works in any dimensions by looking at the representations of the maximal theory that are listed in Table 1. In the case of the “10B-” and 9-dimensional case, the fields in Table 3 simply correspond to the $SL(2, \mathbb{R})$ singlets in Table 1. In eight dimensions, as mentioned above, the 8A theory corresponds to considering the $SL(2, \mathbb{R})$ inside $SL(3, \mathbb{R})$. The $\mathbf{3}$ and the $\bar{\mathbf{3}}$ both decompose as $\mathbf{2} + \mathbf{1}$, while the $\mathbf{8}$ decomposes as $\mathbf{3} + \mathbf{2} + \mathbf{2} + \mathbf{1}$ and the $\mathbf{6}$ decomposes as $\mathbf{3} + \mathbf{2} + \mathbf{1}$. Taking only the singlets, this reproduces all the forms up to $p = 7$ included in the 8A theory in Table 3. The 8-forms arise from the singlets in the decompositions of the $\mathbf{15}$ and of the $\mathbf{3}$, which both have one $SL(2, \mathbb{R})$ singlet. As a result, one would expect 8-forms in the $\mathbf{3}$ and $\mathbf{1}$ of the remaining $SL(2, \mathbb{R})$ as Table 3 shows, but the singlet appears with multiplicity 2 instead of 3, as the decomposition would suggest. The same occurs for the 8B theory, which corresponds to taking the singlets of the $SL(2, \mathbb{R})$ which is *not* inside $SL(3, \mathbb{R})$ in the eight-dimensional maximal theory. From Table 1, one gets that the 8-forms in the $\mathbf{3}$ should have multiplicity 2, while they occur with multiplicity 1 in Table 3.

The reader can check that the same phenomenon occurs in any dimension. All the representations of Table 3 result from truncating the representations of Table 1 to the singlets of $SL(2, \mathbb{R})$. Only for the D -forms in D dimensions and the 2-forms in three dimensions the multiplicity of the lower-dimensional representations is in general smaller than the multiplicity that results from the decomposition to the singlets of $SL(2, \mathbb{R})$. This can be understood by observing that if a given potential has multiplicity n , it means that in the gauge algebra there are actually n potentials whose gauge transformations with respect to the various gauge parameters of the theory are all different. Once all the fields and gauge parameters are truncated to the singlets of $SL(2, \mathbb{R})$, some of the gauge transformations above become identical and the corresponding potentials are identified, with the effect of lowering at least partially the multiplicity.

Given that these theories arise in any dimension as a specific truncation of the maximal

($E_{8(8)}^{+++}$) theory in which an $SL(2, \mathbb{R})$ subgroup of the global symmetry group is factored out, one can in principle hope to realise such truncation in perturbative string theory in D dimensions only if this subgroup is part of the perturbative $SO(10 - D, 10 - D)$ symmetry. The highest dimension in which this occurs is $D = 8$, where the perturbative symmetry is the $SL(2, \mathbb{R}) \times SL(2, \mathbb{R})$ subgroup of the global symmetry group $SL(3, \mathbb{R}) \times SL(2, \mathbb{R})$. In the IIA case, the ‘geometric’ $SL(2, \mathbb{R})$, that is the one associated to the complex structure of the torus, is the first $SL(2, \mathbb{R})$, namely the one contained in $SL(3, \mathbb{R})$. As a consequence, the 8A theory obtained by factoring out this group could in principle be obtained from the Type IIA theory *via* some kind of geometric orbifold of the two-torus T^2 . On the other hand, in the IIB case it is the second $SL(2, \mathbb{R})$ which is the ‘geometric’ one. Hence, the 8B theory that results from factoring out this group could in principle be realised as a geometric orbifold of the Type IIB theory.

The fact that $D = 8$ is the highest dimension in which the \mathbb{H}_s -based magic non-supersymmetric theory could be realised in perturbative string theory can also be easily deduced from the $E_{7(7)}^{+++}$ Dynkin diagram in fig. 3, as already discussed in [26]. The general rule is that for this to be possible, one must be able to decompose the global symmetry in $SO(m, m)$ for a given m ; in the particular case of the $E_{7(7)}^{+++}$ Dynkin diagram, this decomposition is achieved by the deletion of node 8. The string dilaton corresponds to the Cartan generator associated to the simple root α_8 , and the perturbative symmetry in D dimensions is³ $SO(8 - D, 8 - D) \times SL(2, \mathbb{R})$, where the second factor corresponds to the simple root α_9 .

We can repeat the previous analysis for the case of the magic non-supersymmetric theories based on \mathbb{C}_s , where the symmetry in $D = 3$ is $E_{6(6)}$. In any dimension, the bosonic sector of the theory can thus be obtained from the Kac-Moody algebra $E_{6(6)}^{+++}$ [25, 26], whose Dynkin diagram is given in fig. 4. From the diagram, one can deduce the symmetry group

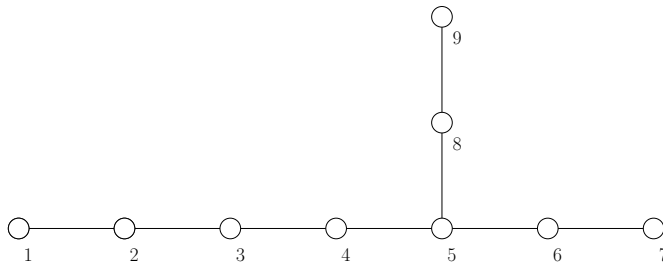

Figure 4: The $E_{6(6)}^{+++}$ Dynkin diagram.

in any dimension, together with the highest dimension to which the theory can be uplifted, $D = 8$ in this case. In Table 4 we give the full spectrum of p -forms of the theory in any allowed dimension D , again including, as in the quaternionic case, $D - 1$ - and D -forms. The p -forms enter the bosonic sector of the theory together with gravity and with the scalars that parametrise the manifold G/H , being H , as usual, the maximal compact subgroup of

³This hints the interpretation of $SL(2, \mathbb{R})$ as $Tri(\mathbb{H}_s)/SO(\mathbb{H}_s)$, where $Tri(\mathbb{H}_s)$ and $SO(\mathbb{H}_s)$ respectively denote the *triality* symmetry and the *norm-preserving* symmetry of \mathbb{H}_s [36].

Dim	Symmetry	$p = 1$	$p = 2$	$p = 3$	$p = 4$	$p = 5$	$p = 6$	$p = 7$
8	$SL(2, \mathbb{R})$			2			3	
7	$GL(2, \mathbb{R})$	1	2	2	1	3 1	3 2	4 2×2
6	$(SL(2, \mathbb{R}))^2 \times \mathbb{R}^+$	(2, 1) (1, 2)	(2, 2)	(2, 1) (1, 2)	(3, 1) (1, 1) (1, 3)	(3, 2) (2, 3) (1, 2) (2, 1)	(4, 2) (2, 4) $3 \times (\mathbf{2, 2})$ (3, 1) (1, 3)	
5	$(SL(3, \mathbb{R}))^2$	(3, 3)	($\overline{\mathbf{3}}, \overline{\mathbf{3}}$)	(8, 1) (1, 8)	($\overline{\mathbf{6}}, \mathbf{3}$) (3, 3) (3, 6)	($\overline{\mathbf{15}}, \overline{\mathbf{3}}$) ($\overline{\mathbf{3}}, \overline{\mathbf{15}}$) $2 \times (\overline{\mathbf{3}}, \overline{\mathbf{3}})$ (6, 3) ($\overline{\mathbf{3}}, \mathbf{6}$)		
4	$SL(6, \mathbb{R})$	20	35	70 $\overline{\mathbf{70}}$	$\overline{\mathbf{280}}$ 280 189			
3	$E_{6(6)}$	78	650 1	$\overline{\mathbf{5824}}$ 5824 650 78				

Table 4: All the p -forms of the $E_{6(6)}^{+++}$ theory in any dimension.

the global symmetry group G . In particular, in three dimensions this gives a total of 42 scalars, which is the number of degrees of freedom in any dimension.

Following the same analysis of the previous case, we observe that the eight-dimensional theory results as a truncation of the maximal theory in which the $SL(3, \mathbb{R})$ part of the global symmetry is modded out. Once again, in any dimension the global symmetry $G_D^{(3)}$ arises in the decomposition $G_D^{(3)} \times SL(3, \mathbb{R})$ of the symmetry of the maximal theory, and the full spectrum in dimension D is a consistent truncation of the one of the maximal theory in dimension D , provided only the singlets with respect to the $SL(3, \mathbb{R})$ are kept. The unique exception to this general rule, already mentioned for the quaternionic theories, occurs for lower-dimensional representations of the D -forms in D dimensions and also of the 2-forms in $D = 3$, whose actual multiplicity is typically lower than the multiplicity resulting from the truncation. As an example, we can analyse the 7-dimensional case. By decomposing the **70**, the **45** and the **5** of $SL(5, \mathbb{R})$ under the maximal subgroup $GL(2, \mathbb{R}) \times SL(3, \mathbb{R})$ and keeping only the $SL(3, \mathbb{R})$ -singlets, one gets a **4** and three **2**'s of $SL(2, \mathbb{R})$, while the doublet in Table 4 only arises with multiplicity 2.

One can again determine the dimensions where an interpretation in terms of a perturbative truncation of the ten-dimensional Type IIA or Type IIB string theory could exist. For this, the requirement that $G \times SL(3, \mathbb{R})$ is contained in the T-duality symmetry of the

maximal theory should be fulfilled. The highest dimension in which this occurs is $D = 7$. Again, this information can be extracted by looking at the Dynkin diagram in fig. 4. Indeed, an $SO(m, m)$ symmetry only arises after deleting both nodes 7 and 9, and the dilaton Cartan generator is indeed the sum of the Cartan generator associated to the simple root α_7 and of the one associated to the simple root α_9 . In any dimension, the perturbative symmetry of the \mathbb{C}_s -based theory is⁴ $SO(7 - D, 7 - D) \times \mathbb{R}^+$.

To summarise, in this section we have fully characterised the $E_{7(7)}^{+++}$ and $E_{6(6)}^{+++}$ theories, associated respectively to \mathbb{H}_s and \mathbb{C}_s , in terms of consistent $SL(2, \mathbb{R})$ and $SL(3, \mathbb{R})$ truncations of the maximal ($E_{8(8)}^{+++}$) theory. In the next section we will show that this generalises to further truncations.

3 Ehlers $SL(n, \mathbb{R})$ truncations of maximal supergravity in any dimension

In the previous section we have shown that the magic non-supersymmetric theories based on \mathbb{C}_s and \mathbb{H}_s can be obtained in any dimensions as suitable truncations of the maximal supergravities. In particular, the chain of Table 3 based on \mathbb{H}_s is obtained by modding out the symmetry $SL(2, \mathbb{R})$, while the chain of Table 4 based on \mathbb{C}_s is obtained by modding out the symmetry $SL(3, \mathbb{R})$. In three dimensions, the modding gives rise to the symmetries $E_{7(7)}$ and $E_{6(6)}$ that coincides with the symmetries of the maximal theory in four and five dimensions, respectively. The symmetry of the four-dimensional theory based on \mathbb{C}_s is $SL(6, \mathbb{R})$, identical to the symmetry of the five-dimensional theory based on \mathbb{H}_s . Ultimately, one may trace the previous relations back to the symmetry of the doubly split magic square [23]. However, as shown in the previous section, the theories based on \mathbb{H}_s and \mathbb{C}_s are also associated to the very-extended Kac-Moody algebras $E_{7(7)}^{+++}$ and $E_{6(6)}^{+++}$. Moreover, as explained before, the fact that these theories arise as truncations of the maximal theory can actually be extended to the full spectrum of p -forms resulting from the very-extended Kac-Moody algebras.

The aim of this section is to extend this analysis to further truncations. We consider the truncation of the maximal theory obtained by modding out the U-duality symmetry G_D (in any dimension) with respect to the symmetry $SL(n, \mathbb{R})$. It can be worked out by considering the embedding

$$G_D \supset SL(n, \mathbb{R}) \times G_D^{(n)} , \quad (3.1)$$

where $G_D^{(n)}$ is the residual symmetry of the truncated theory in D dimensions. The resulting groups form the split magic triangle of [30] displayed in Table 5: in its first column, the various $SL(n, \mathbb{R})$'s are reported, while in the remaining columns the resulting $G_D^{(n)}$'s for each G_D are given. In particular, the second column gives the various decompositions of the three-dimensional theory, the third column gives the various decompositions of the

⁴This hints the interpretation of \mathbb{R}^+ as $Tri(\mathbb{C}_s)/SO(\mathbb{C}_s)$, where $Tri(\mathbb{C}_s)$ and $SO(\mathbb{C}_s)$ respectively denote the *triality* symmetry and the *norm-preserving* symmetry of \mathbb{C}_s [36].

$SL(n)$	$D = 3$	$D = 4$	$D = 5$	$D = 6$	$D = 7$	$D = 8$	$D = 9$	$D = 10A$	$D = 10B$	$D = 11$
$n = 1$	$E_{8(8)}$	$E_{7(7)}$	$E_{6(6)}$	$SO(5, 5)$	$SL(5)$	$SL(3) \times SL(2)$	$GL(2)$	\mathbb{R}^+	$SL(2)$	1
$n = 2$	$E_{7(7)}$	$SO(6, 6)$	$SL(6)$	$SL(2) \times SL(4)$	$SL(3) \times \mathbb{R}^+$	$SL(2) \times \mathbb{R}^+$	\mathbb{R}^+		1	
$n = 3$	$E_{6(6)}$	$SL(6)$	$SL(3) \times SL(3)$	$SL(2) \times SL(2) \times \mathbb{R}^+$	$SL(2) \times \mathbb{R}^+$	$SL(2)$				
$n = 4$	$SO(5, 5)$	$SL(4) \times SL(2)$	$SL(2) \times SL(2) \times \mathbb{R}^+$	$(\mathbb{R}^+)^2$ $SL(2) \times SL(2)$	\mathbb{R}^+					
$n = 5$	$SL(5)$	$SL(3) \times \mathbb{R}^+$	$SL(2) \times \mathbb{R}^+$	\mathbb{R}^+	1					
$n = 6$	$SL(3) \times SL(2)$	$SL(2) \times \mathbb{R}^+$	$SL(2)$							
$n = 7$	$SL(2) \times \mathbb{R}^+$	\mathbb{R}^+								
$n = 8A$	\mathbb{R}^+									
$n = 8B$	$SL(2)$	1								
$n = 9$	1									

Table 5: All the relevant regular subgroups that occur in the $SL(n, \mathbb{R})$ truncations of the U-duality symmetry groups of maximal supergravity in any dimension, forming the split magic triangle of [30].

four-dimensional theory, and so on. Obviously, $G_D^{(1)} = G_D$ and the $n = 2$ and $n = 3$ decompositions are just the two sequences discussed in Section 2.

For each n (or, equivalently, for each row in the table), the different entries correspond to the groups that one obtains decomposing the Kac-Moody algebra $G_3^{(n)+++}$ in various dimensions. The $n = 2$ and $n = 3$ cases correspond to the theories we discussed in the previous section, while for $n = 4$ and $n = 5$ one obtains the symmetry groups of the $SO(5, 5)^{+++}$ and $SL(5, \mathbb{R})^{+++}$ theories⁵. We will show below that the spectrum of these theories can indeed be constructed as a consistent truncation of the spectrum of the maximal theory, in which only singlets of $SL(4, \mathbb{R})$ and $SL(5, \mathbb{R})$ are respectively kept.

If one further extends this identification of the truncated theory with $G_3^{(n)+++}$ to higher values of n , one gets that the $n = 6$ case corresponds to the $(SL(3, \mathbb{R}) \times SL(2, \mathbb{R}))^{+++}$ theory. In [29], a way of defining the Kac-Moody very-extended algebras G^{+++} with G semi-simple but not simple was derived, and a method to obtain the spectrum of the theory by suitably decomposing the corresponding Dynkin diagram was given. We will show that, apart from subtleties concerning the multiplicities of lower-dimensional representations of the higher-rank forms, the method of [29] applied to $(SL(3, \mathbb{R}) \times SL(2, \mathbb{R}))^{+++}$ gives results that are in agreement with the $n = 6$ truncation. Going beyond $n = 6$, we should point out that there are two possible decompositions for $n = 8$, which we call $n = 8A$ and $n = 8B$. The cases with $n \geq 7$ (with the exception of the $n = 8B$ case) correspond to very-extended algebras that are *not* semi-simple. One can easily notice that Table 5 is *symmetric*, and in particular $G_D^{(n)}$ is the same as $G_{n+2}^{(D-2)}$. In other words, the group that one obtains by modding the D -dimensional duality group by $SL(n, \mathbb{R})$ is the same as the one coming out by modding the duality group in $n + 2$ dimensions by $SL(D - 2, \mathbb{R})$. This symmetry was firstly explained in [38] exploiting the relation discovered in [39] between exceptional groups and del Pezzo surfaces.

For the $n = 4$ truncation, one obtains the $SO(5, 5)^{+++}$ theory, whose Dynkin diagram

⁵These are $\mathcal{N} = 0$ or $\mathcal{N} = 1$ theories in $D = 3$ (upliftable to $\mathcal{N} = 0$ theories in $D = 4$) [31, 37].

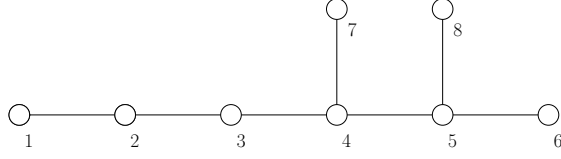

Figure 5: The $SO(5,5)^{+++}$ Dynkin diagram.

is shown in fig. 5. From it, one can see that the theory can be uplifted at most to seven dimensions, which indeed coincides with the highest dimension in which one can embed $SL(4, \mathbb{R})$ in the symmetry of the maximal theory. In six dimensions there are two possibilities: the 6A theory, obtained by deleting nodes 6, 7 and 8, is the dimensional reduction of the seven-dimensional theory, while the 6B theory corresponds to deleting node 5. The presence of two theories corresponds to the two different embeddings of $SL(4, \mathbb{R})$ inside $SO(5,5)$. In Table 6, we report the spectrum of p -forms obtained in various dimensions from the Kac-Moody algebra $SO(5,5)^{+++}$. The representations are those that result from retaining only the $SL(4, \mathbb{R})$ -singlets in the decomposition of the

Dim	Symmetry	$p = 1$	$p = 2$	$p = 3$	$p = 4$	$p = 5$	$p = 6$	$p = 7$
7	\mathbb{R}^+		1	1		1	1	1
6A	$(\mathbb{R}^+)^2$	$2 \times \mathbf{1}$	$2 \times \mathbf{1}$	$2 \times \mathbf{1}$	$2 \times \mathbf{1}$	$4 \times \mathbf{1}$	$7 \times \mathbf{1}$	
6B	$(SL(2, \mathbb{R}))^2$		(2, 2)		(3, 1) (1, 3)		(4, 2) (2, 4) (2, 2)	
5	$(SL(2, \mathbb{R}))^2 \times \mathbb{R}^+$	(2, 2) (1, 1)	(2, 2) (1, 1)	(3, 1) (1, 3) (1, 1)	(3, 1) (1, 3) $2 \times \mathbf{(2, 2)}$	(4, 2) (2, 4) $3 \times \mathbf{(2, 2)}$ (3, 1) (1, 3) $2 \times \mathbf{(1, 1)}$		
4	$SL(4, \mathbb{R}) \times SL(2, \mathbb{R})$	(6, 2)	(15, 1) (1, 3)	(10, 2) (10, 2) (6, 2)	(45, 1) (45, 1) $2 \times \mathbf{(15, 3)}$ $2 \times \mathbf{(15, 1)}$ (1, 3)			
3	$SO(5, 5)$	45	210 54 1	1050 1050 945 210 54 45				

Table 6: All the p -forms of the $SO(5,5)^{+++}$ theory in every dimension.

Dim	Symmetry	$p = 1$	$p = 2$	$p = 3$	$p = 4$	$p = 5$	$p = 6$
7	–						
6	\mathbb{R}^+	1		1	1		1
5	$GL(2, \mathbb{R})$	2	2	3 1	2 1	4 2×2	
4	$GL(3, \mathbb{R})$	3 $\bar{3}$	8 1	6 $\bar{6}$ 3 $\bar{3}$	10 $\bar{10}$ 3×8 3 $\bar{3}$ 1		
3	$SL(5, \mathbb{R})$	24	75 24 1	175 $\bar{175}$ 126 $\bar{126}$ 2×75 2×24			

Table 7: All the p -forms of the $SL(5, \mathbb{R})^{+++}$ theory in any dimension.

representations of the symmetry G_D of the maximal theory with respect to $SL(n, \mathbb{R}) \times G_D^{(n)}$. As in the cases discussed in the previous section, the only exceptions to this rule are the lower-dimensional representations of the D -forms, which always have actual multiplicity lower than what would result from the truncation. The number of bosonic degrees of freedom in any dimension is 25, which is the dimension of the $D = 3$ coset manifold $SO(5, 5)/[SO(5) \times SO(5)]$.

In Section 2, we have discussed the possible realizations within perturbative string theory of the magic non-supersymmetric theories based on \mathbb{C}_s and \mathbb{H}_s . In particular, we have observed that a necessary condition is that the $SL(2, \mathbb{R})$ or $SL(3, \mathbb{R})$ symmetry (the factored out term) commutes with the string-dilaton generator. In particular, the theory based on the split quaternions \mathbb{H}_s could admit a string interpretation at most in $D = 8$, while the theory based on the split complex numbers \mathbb{C}_s could be obtained in perturbative string theory at most in $D = 7$. In particular, we showed how this can be read from the Kac-Moody algebra by looking at the highest dimension in which the symmetry group contains a subgroup $SO(m, m)$ [26]. In the case of the $SO(5, 5)^{+++}$ theory, the Dynkin diagram in fig. 5 exhibits a T-duality symmetry already in seven dimensions, corresponding to the exchange of the nodes 6 and 8. This is in agreement with the fact that $SL(4, \mathbb{R})$ is isomorphic to $SO(3, 3)$, and therefore it can be identified with the perturbative symmetry of the maximal theory in seven dimensions.

For the $n = 5$ truncation, one obtains the $SL(5, \mathbb{R})^{+++}$ theory, whose Dynkin diagram is shown in fig. 6. In this case, the highest dimension to which this theory can be uplifted is 7, corresponding to the deletion of node 7 (or node 4). In seven dimensions, such a

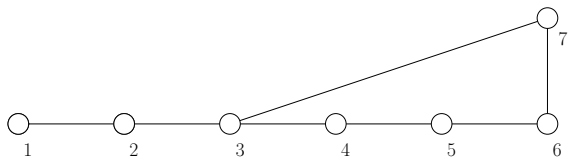

Figure 6: The $SL(5, \mathbb{R})^{+++}$ Dynkin diagram.

theory is nothing but pure gravity [40], in agreement with the fact that all the fields of the maximal theory in seven dimensions except the graviton are non-singlets of the global symmetry $SL(5, \mathbb{R})$. In Table 7 we list the spectrum of forms in various dimensions. The number of bosonic degrees of freedom, coincident with the dimension of the $D = 3$ manifold $SL(5, \mathbb{R})/SO(5)$, is 14. This theory can admit a possible interpretation in perturbative string theory starting from five dimensions. Indeed, $SL(5, \mathbb{R})$ can be embedded in the perturbative symmetry $SO(5, 5)$ in five dimensions. Moreover, looking at the diagram in fig. 6, a group of $SO(m, m)$ type requires at least the deletion of nodes 5 and 6.

Let us now discuss the $n = 6$ truncation, corresponding to the $(SL(3, \mathbb{R}) \times SL(2, \mathbb{R}))^{+++}$ Kac-Moody algebra⁶. It is the first example, in this context, of a very-extended G^{+++} algebra with G non-simple (namely, semi-simple). As mentioned before, in [29] it has been shown that for a Kac-Moody algebra of the form $(G_1 \times G_2)^{+++}$ one can write down a suitable Dynkin diagram in which the affine nodes of G_1^+ and G_2^+ are connected. From that diagram, one can then determine the spectrum of the theory in various dimensions, modulo the subtlety that one has to remove the extra Cartan generator that *always* occurs in the spectrum. In our case, the Dynkin diagram is given in fig. 7. The highest dimension

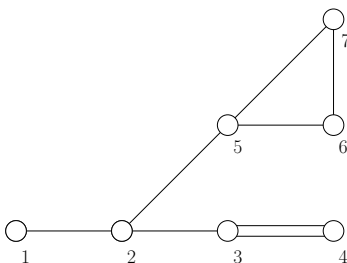

Figure 7: The $(SL(3, \mathbb{R}) \times SL(2, \mathbb{R}))^{+++}$ Dynkin diagram.

to which the theory can be uplifted is 5, corresponding to the deletion of nodes 3 and 7, and resulting in the global symmetry $SL(2, \mathbb{R})$. Indeed, $SL(6, \mathbb{R})$ can be embedded in $E_{6(6)}$ but not in $SO(5, 5)$. In four dimensions there are two theories: the 4A is the reduction of the five-dimensional theory, with a global symmetry $GL(2, \mathbb{R})$ while the 4B has global symmetry $SL(3, \mathbb{R})$. We list in Table 8 the spectrum of forms derived from the Kac-Moody algebra. The number of bosonic degrees of freedom is 7, like the dimension of the scalar manifold in $D = 3$. In any dimension, the spectrum coincides with truncating the maximal theory to singlets of $SL(6, \mathbb{R})$, again with the exception of the lower-dimensional

⁶This is an $\mathcal{N} = 0$ or $\mathcal{N} = 1$ theory in $D = 3$ (upliftable to $\mathcal{N} = 0$ in $D = 4$) [31, 37].

Dim	Symmetry	$p = 1$	$p = 2$	$p = 3$	$p = 4$
5	$SL(2, \mathbb{R})$			3	
4A	$GL(2, \mathbb{R})$	$2 \times \mathbf{1}$	3 1	$2 \times \mathbf{3}$	$3 \times \mathbf{3}$
4B	$SL(3, \mathbb{R})$		8		10 10 8
3	$SL(3, \mathbb{R}) \times SL(2, \mathbb{R})$	(8, 1) (1, 3)	(8, 3) (8, 1) $2 \times \mathbf{(1, 1)}$	(10, 3) (10, 3) $3 \times \mathbf{(8, 3)}$ $3 \times \mathbf{(8, 1)}$ (1, 3)	

Table 8: All the p -forms of the $(SL(3, \mathbb{R}) \times SL(2, \mathbb{R}))^{+++}$ theory in any dimension.

representations of the D -forms in D dimensions and the 2-forms in three dimensions. In four dimensions, as emerging from the diagram in fig. 7 by deleting nodes 4, 6 and 7, one can embed $SL(6, \mathbb{R})$ inside the perturbative symmetry $SO(6, 6)$.

Among the truncations with $n > 6$, the $n = 8B$ case corresponds to the Kac-Moody algebra $SL(2, \mathbb{R})^{+++}$, which is pure gravity in four dimensions [40], $SL(2, \mathbb{R})$ being nothing but the Ehlers symmetry in the reduction $D = 4 \rightarrow 3$ of General Relativity itself [41] (also *cfr.* [27]). Indeed, decomposing the $E_{7(7)}$ representations of the maximal theory in four dimensions under $SL(8, \mathbb{R})$ one finds that no singlets occur and therefore only the graviton survives the projection (see Table 1). The spectrum of forms as derived from the Kac-Moody algebra is reported in Table 9. In three dimensions the 1-forms are in agreement with the truncation, while there is only one singlet 2-form instead of the two singlets that would survive the truncation. There are no 3-forms, while the truncation would give a **3** from the **248** and a singlet from the **3875**. For the highest-dimensional **147250** representation of 3-forms in the maximal theory nothing survives the truncation.

The remaining cases $n = 7, 8A$ and 9 correspond to *non-semi-simple* three-dimensional symmetries. The resulting list of the truncations is in Table 10. The $n = 7$ theory exists in four and three dimensions, while the other two cases only exist in three dimensions.

Dim	Symmetry	$p = 1$	$p = 2$
4	—		
3	$SL(2, \mathbb{R})$	3	1

Table 9: All the p -forms of the $SL(2, \mathbb{R})^{+++}$ theory in any dimension.

n	Dim	Symmetry	$p = 1$	$p = 2$	$p = 3$	$p = 4$
$n = 7$	4	\mathbb{R}^+		1	$2 \times \mathbf{1}$	$2 \times \mathbf{1}$
	3	$GL(2, \mathbb{R})$	3 1	3	$2 \times \mathbf{4}$	
				$2 \times \mathbf{2}$	$6 \times \mathbf{3}$	$6 \times \mathbf{2}$
			$3 \times \mathbf{1}$	$6 \times \mathbf{1}$		
$n = 8A$	3	\mathbb{R}^+	1	$2 \times \mathbf{1}$	$5 \times \mathbf{1}$	
$n = 9$	3	–		1		

Table 10: All the p -forms that arise from the $n = 7, 8A, 9$ truncations of the maximal theory in any dimension.

4 Ehlers $SL(n, \mathbb{R})$ truncations: non-maximal cases

In this section we briefly discuss how the analysis carried out in the previous two sections can be generalised to the 1/2-maximal theories (16 supersymmetries) and the 1/4-maximal theories (8 supersymmetries). The crucial difference with respect to the maximal case is that the symmetry groups of these theories are not in the split real form⁷. The only exception is the magic theory based on \mathbb{R} , whose symmetry in three dimensions is $F_{4(4)}$. In [16] it was shown that in general if G_3 is non-split, then the very-extended Kac-Moody algebra G_3^{+++} corresponding to the supergravity theory has reality properties that result from considering the Tits-Satake diagram, which is the one appropriate to identify the real form of the three-dimensional symmetry G_3 . From it, as in the maximal case, it is then possible to derive the full spectrum of forms, along with the surviving real form of the symmetry in any dimensions. Moreover, the nodes associated to the compact Cartan generators in the Tits-Satake diagram determine the highest dimension to which the theory can be uplifted.

We first consider the 1/4-maximal, magic theories [18–20] based on \mathbb{C} , \mathbb{H} and \mathbb{O} , and the corresponding decomposition according to equation (3.1) of the U-duality symmetries. The result is the chain of theories displayed in Table⁸ 11. As in the analogous Table 5 for the maximal theory, Table 11 is *symmetric*. In all cases, the $n = 2$ truncation can

⁷For the relation between these models and del Pezzo surfaces, see [42]

⁸Some comments on Table 11 are in order. The $D = 3$ theories with U-duality $E_{6(-26)}$, $SO(1, 9)$, $SU^*(6)$, $SU(2) \times SO(1, 5)$, $SL(3, \mathbb{C})_{\mathbb{R}}$ and $U(1) \times SO(1, 3)$ are not present in table 2 of [31] because these theories ($\mathcal{N} = 0$ or $\mathcal{N} = 1$ in $D = 3$) *cannot* be uplifted to $D = 4$. Interestingly, $SO(1, 9)$ shares with $F_{4(-20)}$ (the actual U-duality of the $\mathcal{N} = 9$, $D = 3$ theory) the same maximal compact subgroup $SO(9)$, which indeed is the $\mathcal{N} = 9$ \mathcal{R} -symmetry in $D = 3$. The theory with U-duality $E_{7(-25)}$ in $D = 3$ can be $\mathcal{N} = 0, 1, 2$, and in the latter case admits an $\mathcal{N} = 1$, $D = 4$ uplift to a theory with U-duality $SO(2, 10)$. Analogously, the theory with U-duality $SO^*(12)$ in $D = 3$ can be $\mathcal{N} = 0, 1, 2$, and in the latter case admits an $\mathcal{N} = 1$, $D = 4$ uplift to a theory with U-duality $SU(2) \times SO(2, 6)$. Moreover, the theory with U-duality $SU(3, 3)$ in $D = 3$ can be $\mathcal{N} = 0, 1, 2$, and in the latter case admits an $\mathcal{N} = 1$, $D = 4$ uplift to a theory with U-duality $U(1) \times SO(2, 4)$. These three cases can be summarised by stating that the theories with U-duality $Conf(\mathbf{J}_3^{\mathbb{A}})$ in $D = 3$ can be $\mathcal{N} = 0, 1, 2$, and in the latter case they admit an $\mathcal{N} = 1$, $D = 4$ uplift to a theory with U-duality $(Tri(\mathbb{A})/SO(\mathbb{A})) \times SO(2, q + 2)$, where $q := \dim_{\mathbb{R}} \mathbb{A} = 8, 4, 2$ for $\mathbb{A} = \mathbb{O}, \mathbb{H}, \mathbb{C}$.

$SL(n)$	$D = 3$	$D = 4$	$D = 5$	$D = 6$
$n = 1$	$E_{8(-24)}$	$E_{7(-25)}$	$E_{6(-26)}$	$SO(1, 9)$
$n = 2$	$E_{7(-25)}$	$SO(2, 10)$		
$n = 3$	$E_{6(-26)}$			
$n = 4$	$SO(1, 9)$			
$n = 1$	$E_{7(-5)}$	$SO^*(12)$	$SU^*(6)$	$SU(2) \times SO(1, 5)$
$n = 2$	$SO^*(12)$	$SU(2) \times SO(2, 6)$		
$n = 3$	$SU^*(6)$			
$n = 4$	$SU(2) \times SO(1, 5)$			
$n = 1$	$E_{6(2)}$	$SU(3, 3)$	$SL(3, \mathbb{C})_{\mathbb{R}}$	$U(1) \times SO(1, 3)$
$n = 2$	$SU(3, 3)$	$U(1) \times SO(2, 4)$		
$n = 3$	$SL(3, \mathbb{C})_{\mathbb{R}}$			
$n = 4$	$U(1) \times SO(1, 3)$			

Table 11: All the relevant subgroups that occur in the $SL(n, \mathbb{R})$ truncations of the U-duality symmetry groups for the 1/4-maximal magic theories (also *cfr.* table 2 of [31]).

be uplifted to four dimensions, while the $n = 3$ and $n = 4$ truncations only exist in three dimensions. In *any* dimension, the spectrum of the theory whose symmetry is $G_3^{(n)}$ in three dimensions can be derived using the corresponding $G_3^{(n)+++}$. The representations of the fields of the theory based on \mathbb{O} , associated to the $E_{8(-24)}^{+++}$ Kac-Moody algebra, coincide with those of the maximal theory in dimension from three to six listed in Table 1, keeping in mind that the reality properties of the representations are different because the groups are in different real forms. Similarly, the spectrum of the $n = 2$ truncation of the theory based on \mathbb{O} , associated to the $E_{7(-25)}^{+++}$ Kac-Moody algebra, can be read by looking at the rows corresponding to $D = 3$ and $D = 4$ in Table 3. This generalises to all the theories listed in Table 11. The analysis of the previous two sections therefore gives the spectrum of all the theories that are truncations of the theories based on \mathbb{O} , as well as the spectrum of the theories based on \mathbb{C} and \mathbb{H} . The spectrum of the theories that arise as truncations of the ones based on \mathbb{C} and \mathbb{H} correspond to the Kac-Moody algebras $SO^*(12)^{+++}$, $SU^*(6)^{+++}$ and $SU(3, 3)^{+++}$, as well as the non-simple cases $(SU(2) \times SO(1, 5))^{+++}$ and $SL(3, \mathbb{C})^{+++}$ and the non-semi-simple case $(U(1) \times SO(1, 3))^{+++}$. We have verified that for all the semi-simple cases the Kac-Moody algebra gives a result consistent with the truncation in the sense explained in the previous two sections.

The case of the magic theory based on \mathbb{R} , corresponding to the Kac-Moody algebra $F_{4(4)}^{+++}$, is special because the corresponding symmetry algebra is not simply laced. The symmetry of the theory is $Sp(6, \mathbb{R})$ in $D = 4$, $SL(3, \mathbb{R})$ in $D = 5$ and $SL(2, \mathbb{R})$ in $D = 6$. The

$n = 2$ truncation of the three-dimensional theory gives a theory with symmetry $Sp(6, \mathbb{R})$, whose spectrum can be read from the $Sp(6, \mathbb{R})^{+++}$ Kac-Moody algebra. This theory can be $\mathcal{N} = 0, 1, 2$ in $D = 3$, and it can be uplifted at most to $\mathcal{N} = 1$, $D = 4$, where it gives a symmetry $SO(2, 3)$ which is the $n = 2$ truncation of the four-dimensional $Sp(6, \mathbb{R})$ theory. On the other hand, the theories in $D = 5$ also seem to admit well-defined $n = 2$ truncations, but these cannot result as the uplift of the $Sp(6, \mathbb{R})^{+++}$ because the roots of the $SL(3, \mathbb{R})$ and the $SL(2, \mathbb{R})$ which are the symmetries in $D = 5$ and $D = 6$ are short roots of $F_{4(4)}$. Similarly, the $n = 3$ and $n = 4$ truncations in three dimensions give theories with symmetries⁹ $SL(3, \mathbb{R})$ and the $SL(2, \mathbb{R})$ respectively, but these theories cannot be obtained from the corresponding very-extended algebras because again the roots of these algebras are short. What this shows is that in general the truncation analysis is more subtle for algebras that are not simply laced.

We now move to consider the 1/4-maximal theories whose symmetry is $SO(4, m)$ in three dimensions (related to the cubic semi-simple Jordan algebra $\mathbb{R} \oplus \mathbf{\Gamma}_{1, m-3}$), as well as to the 1/2-maximal theories whose symmetry is $SO(8, m)$ (related to the cubic semi-simple Jordan algebra $\mathbb{R} \oplus \mathbf{\Gamma}_{5, m-3}$). We list the results of the truncations according to equation (3.1) in Tables 12 and 13. As Table 12 shows, analogously to the magic case, the $n = 2$ truncation of the 1/4-maximal theory is defined in three and four dimensions, while the $n = 3$ and $n = 4$ truncations are only defined in three dimensions. There are two different $n = 2$ truncations in four dimensions, corresponding to the fact that the $(SL(2, \mathbb{R}) \times SO(2, m-2))^{+++}$ Kac-Moody algebra (whose Tits-Satake diagram can be drawn following the prescription of [29]) admits two different uplifts to four dimensions. Similarly, the three-dimensional theory admits two different $n = 4$ truncations, corresponding to the fact that there are two theories in six dimensions, that we call 6A and 6B. Exactly the same considerations apply to the truncations of the 1/2-maximal theories whose symmetries are listed in Table 13. In this case the real form is such that the theory admits an uplift to ten dimensions.

In general, the embedding that one has to consider for the $SL(n, \mathbb{R})$ truncation of these theories is

$$SO(q, r) \supset SO(n, n) \times SO(q - n, r - n) , \quad (4.1)$$

and therefore the truncation is only possible if both q and r are greater or equal to n . For generic n , the $SO(n, n)$ subgroup is further decomposed as $\mathbb{R}^+ \times SL(n, \mathbb{R})$, and the $SL(n, \mathbb{R})$ factor is the one that is truncated. This explains all the entries in Tables 12 and 13, with the only exceptions of $n = 2$ and $n = 4$. In the $n = 2$ case, for generic D , one uses the isomorphism between $SO(2, 2)$ and $SL(2, \mathbb{R}) \times SL(2, \mathbb{R})$ and after the truncation an $SL(2, \mathbb{R})$ subgroup remains. In $D = 4$ the symmetry group is $SL(2, \mathbb{R}) \times SO(2, m-2)$ in the 1/4-maximal case and $SL(2, \mathbb{R}) \times SO(6, m-2)$ in the 1/2-maximal case, and therefore an additional $n = 2$ truncation is allowed where the $SL(2, \mathbb{R})$ factor in the symmetry group is truncated out. Finally, for $n = 4$, apart from the standard decomposition which is valid for any n , one can also consider the embedding in eq. (4.1) for $n = 3$ and identify $SO(3, 3)$

⁹While the $D = 3$ $SL(3, \mathbb{R})$ theory can only be $\mathcal{N} = 0, 1$ and it does not admit a supersymmetric uplift to $D = 4$, the $D = 3$ $SL(2, \mathbb{R})$ theory can be $\mathcal{N} = 0, 1, 2$, and in the latter case it can be regarded as the dimensional reduction of “pure” $\mathcal{N} = 1$, $D = 4$ supergravity.

$SL(n)$	$D = 3$	$D = 4$	$D = 5$	$D = 6A$	$D = 6B$
$n = 1$	$SO(4, m)$	$SL(2, \mathbb{R}) \times SO(2, m - 2)$	$\mathbb{R}^+ \times SO(1, m - 3)$	$\mathbb{R}^+ \times SO(m - 4)$	$SO(1, m - 3)$
$n = 2$	$SL(2, \mathbb{R}) \times SO(2, m - 2)$	$SL(2, \mathbb{R}) \times SL(2, \mathbb{R}) \times SO(m - 4)$ $SO(2, m - 2)$			
$n = 3$	$\mathbb{R}^+ \times SO(1, m - 3)$				
$n = 4A$	$\mathbb{R}^+ \times SO(m - 4)$				
$n = 4B$	$SO(1, m - 3)$				

Table 12: All the relevant subgroups of the duality symmetry groups of the SO theories with 8 supersymmetries.

$SL(n)$	$D = 3$	$D = 4$	$D = 5$	$D = 6A$	$D = 6B$	$D = 7$	$D = 8$	$D = 9$	$D = 10$
$n = 1$	$SO(8, m)$	$SL(2) \times SO(6, m - 2)$	$\mathbb{R}^+ \times SO(5, m - 3)$	$\mathbb{R}^+ \times SO(4, m - 4)$	$SO(5, m - 3)$	$\mathbb{R}^+ \times SO(3, m - 5)$	$\mathbb{R}^+ \times SO(2, m - 6)$	$\mathbb{R}^+ \times SO(1, m - 7)$	$SO(m - 8)$
$n = 2$	$SL(2) \times SO(6, m - 2)$	$SL(2) \times SL(2) \times SO(4, m - 4)$ $SO(6, m - 4)$	$\mathbb{R}^+ \times SL(2) \times SO(3, m - 5)$	$\mathbb{R}^+ \times SL(2) \times SO(2, m - 6)$	$SL(2) \times SO(3, m - 5)$	$\mathbb{R}^+ \times SL(2) \times SO(1, m - 7)$	$\mathbb{R}^+ \times SL(2) \times SO(m - 8)$		
$n = 3$	$\mathbb{R}^+ \times SO(5, m - 3)$	$\mathbb{R}^+ \times SL(2) \times SO(3, m - 5)$	$\mathbb{R}^+ \times \mathbb{R}^+ \times SO(2, m - 6)$	$\mathbb{R}^+ \times \mathbb{R}^+ \times SO(1, m - 7)$	$\mathbb{R}^+ \times SO(2, m - 6)$	$\mathbb{R}^+ \times \mathbb{R}^+ \times SO(m - 8)$			
$n = 4A$	$\mathbb{R}^+ \times SO(4, m - 4)$	$\mathbb{R}^+ \times SL(2) \times SO(2, m - 6)$	$\mathbb{R}^+ \times \mathbb{R}^+ \times SO(1, m - 7)$	$\mathbb{R}^+ \times \mathbb{R}^+ \times SO(m - 8)$	$\mathbb{R}^+ \times SO(1, m - 7)$				
$n = 4B$	$SO(5, m - 3)$	$SL(2) \times SO(3, m - 5)$	$\mathbb{R}^+ \times SO(2, m - 6)$	$\mathbb{R}^+ \times SO(1, m - 7)$	$SO(2, m - 6)$	$\mathbb{R}^+ \times SO(m - 8)$			
$n = 5$	$\mathbb{R}^+ \times SO(3, m - 5)$	$\mathbb{R}^+ \times SL(2) \times SO(1, m - 7)$	$\mathbb{R}^+ \times \mathbb{R}^+ \times SO(m - 8)$		$\mathbb{R}^+ \times SO(m - 8)$				
$n = 6$	$\mathbb{R}^+ \times SO(2, m - 6)$	$\mathbb{R}^+ \times SL(2) \times SO(m - 8)$							
$n = 7$	$\mathbb{R}^+ \times SO(1, m - 7)$								
$n = 8$	$\mathbb{R}^+ \times SO(m - 8)$								

Table 13: All the relevant regular subgroups of the duality symmetry groups in any dimension for theories with 16 supersymmetries.

Dim	Symmetry	$p = 1$	$p = 2$	$p = 3$	$p = 4$	$p = 5$	$p = 6$
6A	$\mathbb{R}^+ \times SO(4, n - 4)$	$A_{1,M}$	$2 \times A_2$	$A_{3,M}$	$A_4 \oplus A_{4,MN}$	$2 \times A_{5,M} \oplus A_{5,MNP}$	$3 \times A_6 \oplus 2 \times A_{6,MN} \oplus A_{6,M,N} \oplus A_{6,MNPQ}$
6B	$SO(5, n - 3)$		$A_{2,M}$		$A_{4,MN}$		$A_{6,M} \oplus A_{6,MN,P}$

Table 14: The p -forms in the 6A and 6B theories with symmetry groups are $\mathbb{R}^+ \times SO(4, n - 4)$ and $SO(5, n - 3)$.

with the $SL(4, \mathbb{R})$ that one truncates away. This way of identifying and truncating the $SL(4, \mathbb{R})$ factor gives rise to the $n = 4$ B theories, while the $n = 4$ A correspond to the standard identification.

Having explicitly identified the truncation, one can work out how the various representations of the p -form potentials are projected on singlets of $SL(n, \mathbb{R})$. In particular, we focus on the six-dimensional 1/2-maximal 6A and 6B theories whose symmetry groups are $\mathbb{R}^+ \times SO(4, n - 4)$ and $SO(5, n - 3)$ as reported in Table 13. The p -forms occurring in these theories are listed in Table 14. It should be noticed that in the table sets of indices are separated by commas, where each set corresponds to the antisymmetric indices within a mixed-symmetry irreducible representation. We want to extract the contributions to the truncation to singlets of $SL(n, \mathbb{R})$. We can consider for instance the 4-forms $A_{4,MN}$, where M, N are vector indices of $SO(4, m - 4)$ in the 6A theory and of $SO(5, m - 3)$ in the 6B theory. The decomposition is

$$A_{4,MN} \rightarrow A_4 \oplus A_{4,\mu\nu} , \quad (4.2)$$

where the μ, ν indices are vector indices of $SO(4 - n, m - 4 - n)$ in 6A and $SO(5 - n, m - 3 - n)$ in 6B. In this expression, the 4-form singlet that arises is the potential which is dual to the \mathbb{R}^+ dilaton that generically occurs in the truncated theory. The same decomposition can be worked out for all the representations in Table 14, and as discussed in the previous section one expects that this procedure gives precisely the spectrum of the truncated theory. As in all other cases, the only exceptions are the 6-forms belonging to the lower-dimensional representations of the symmetry group, whose multiplicity is less than what one would get by truncating on the $SL(n, \mathbb{R})$ singlets.

By performing the truncation on all the fields in Table 14, one finds that the 6A- and 6B-truncated theories differ with respect to the initial theories only in the appearance of additional singlets. This is a completely general result. The $SL(n, \mathbb{R})$ truncation of the theories with orthogonal symmetry groups $SO(q, r)$ produces a theory with reduced symmetry $SO(q - n, r - n)$ containing p -form potentials that are, rank by rank, the same tensors of the parent theory, with the only addition of singlets. The analysis of the four dimensional case can also be similarly carried out but it is slightly more complicated because of the non-simple symmetry and the fact that the previous statement holds only in the orthogonal sector.

5 Black holes and duality orbits

In Section 2 we have analysed the three-dimensional $E_{7(7)}$ and $E_{6(6)}$ theories based on split quaternions \mathbb{H}_s and split complex numbers \mathbb{C}_s respectively, showing how they can be obtained as truncations of the maximal supergravity and deriving their uplifts to higher dimensions. In this section, we shall study the orbit stratification of the relevant representation space of the black-hole charges under the non-transitive action of the global (duality) symmetry group. This is particularly relevant in the classification of the (extremal) black-hole solutions of the corresponding theory. As mentioned above, together with the three-dimensional maximal theory $E_{8(8)}$ based on split octonions \mathbb{O}_s , the two magic non-supersymmetric theories exhibit, upon dimensional reduction to $D = 3$, a duality group of (split) $E_{n(n)}$ type. The same group can also be realised as *quasi-conformal* [43] group of the corresponding cubic Jordan algebra $J_3^{\mathbb{A}_s}$ over the division algebras $\mathbb{A}_s = \mathbb{C}_s, \mathbb{H}_s, \mathbb{O}_s$. The relevant magic square displaying all the corresponding duality Lie algebras is the *doubly split* magic square $\mathcal{L}_3(\mathbb{A}_s, \mathbb{B}_s)$ [23, 24, 44] given in Table 2.

The theory over \mathbb{O}_s is maximal supergravity, and the stratification of U-orbits of asymptotically flat-branes in $D = 4, 5, 6$ dimensions is known [32, 34, 45–47]. On the other hand, as pointed out above, the theories over \mathbb{H}_s and \mathbb{C}_s are *non-supersymmetric*; namely, their bosonic Lagrangian density cannot be identified with the purely bosonic sector of a supergravity theory. For this reason, they did not receive great attention in literature¹⁰, despite their presence in the classification of symmetric non-linear sigma models coupled to Maxwell-Einstein gravity (*cfr.* table 2 of [31]).

The Jordan algebraic formalism used to classify extremal black hole orbits in the maximal case in $D = 4, 5$ can be generalised to the theories based on \mathbb{C}_s and \mathbb{H}_s . In order to show how to proceed, it can be useful to consider as an example the theories based on \mathbb{C}_s . In four dimensions, their duality group is $SL(6, \mathbb{R})$ and the scalar manifold reads

$$\frac{\text{Conf}\left(J_3^{\mathbb{C}_s}\right)}{\text{mcs}\left(\text{Conf}\left(J_3^{\mathbb{C}_s}\right)\right)} = \frac{SL(6, \mathbb{R})}{SO(6)}, \quad (5.1)$$

where $\text{Conf}\left(J_3^{\mathbb{C}_s}\right) \simeq \text{Aut}\left(\mathfrak{F}\left(J_3^{\mathbb{C}_s}\right)\right)$ is the *conformal* group [43] of the cubic Jordan algebra $J_3^{\mathbb{C}_s}$ or, equivalently, the automorphism group of the Freudenthal triple system (FTS) \mathfrak{F} over $J_3^{\mathbb{C}_s}$ [51], and *mcs* stands for *maximal compact subgroup*. The 0-brane (black hole) dyonic irreducible representation is the rank-3 antisymmetric self-dual (real) $\mathbf{20}$, so that the pair $(SL(6, \mathbb{R}), \mathbf{20})$ defines a group “of E_7 -type”, characterised by a unique primitive quartic invariant polynomial I_4 [52–55]. The action of $SL(6, \mathbb{R})$ on the $\mathbf{20}$ representation determines the stratification into orbits, classified in terms of invariant constraints on I_4 or, equivalently, in terms of the *rank* of the corresponding representative in the Freudenthal

¹⁰For symmetries of Freudenthal triple systems and cubic Jordan algebras defined over split algebras, *cfr.* e.g. [43], [44], table 1 of [48], and Refs. therein. Theories over split algebras have been recently considered, in a different context, in [49]. Furthermore, \mathbb{C}_s - and \mathbb{H}_s - valued scalar fields have also been recently considered in cosmology [50].

triple system $\mathfrak{F} \left(J_3^{\mathbb{C}^s} \right)$ [56, 57]. Below we list the stratification together with the corresponding values of the quartic invariant.

Rank 1: The rank 1 orbit is simply

$$\frac{SL(6, \mathbb{R})}{[SL(3, \mathbb{R}) \times SL(3, \mathbb{R})] \ltimes \mathbb{R}^{(3,3')}} \quad (5.2)$$

Rank 2: The rank two orbit reads

$$\frac{SL(6, \mathbb{R})}{[Sp(4, \mathbb{R}) \times SO(1, 1)] \ltimes (\mathbb{R}^{(4,2)} \times \mathbb{R})} \quad (5.3)$$

where $\mathbb{R}^{(4,2)} \simeq (\mathbf{4}, \mathbf{2})$ denotes the real bi-fundamental¹¹ of the split form $Sp(4, \mathbb{R}) \times SO(1, 1) \simeq SO(3, 2) \times SO(1, 1)$.

Rank 3: There is only one rank 3 orbit

$$\frac{SL(6, \mathbb{R})}{SL(3, \mathbb{R}) \ltimes \mathbb{R}^8} \quad (5.4)$$

where $\mathbb{R}^8 \simeq \mathbf{8}$ denotes the adjoint of $SL(3, \mathbb{R})$.

Rank 4: In the rank 4 case the quartic invariant I_4 is different from zero and there is a splitting of the orbits, depending on the I_4 sign:

$$I_4 > 0 : \frac{SL(6, \mathbb{R})}{SL(3, \mathbb{C})_{\mathbb{R}}} \quad (5.5a)$$

and the dyonic

$$I_4 < 0 : \frac{SL(6, \mathbb{R})}{SL(3, \mathbb{R}) \times SL(3, \mathbb{R})} \quad (5.5b)$$

are the two orbits of rank-4 elements of the FTS \mathfrak{F} over $J_3^{\mathbb{C}^s}$.

It should be noticed that, apart from the rank 4 case where it is induced by the dyonic solution, for a fixed rank of the FTS there is no stratification of the orbits. The absence of stratification can be traced back to the structure of the duality algebra and of its relevant FTS space. In particular, for maximal theories it has been shown [32, 34, 45–47] that rank 1 elements in the Jordan algebra construction correspond to single-charge solutions, while higher rank elements correspond to multi-charge solutions. Orbits of black hole solution related to different values of the rank can be computed using bound states of weights in the representation of the duality charges. The number of weights in the bound state must be equal to the rank in the Jordan algebra construction [32]. The stratification reflects the equivalence or the difference between the considered combinations of weights, while the absence of splitting signals degeneracy.

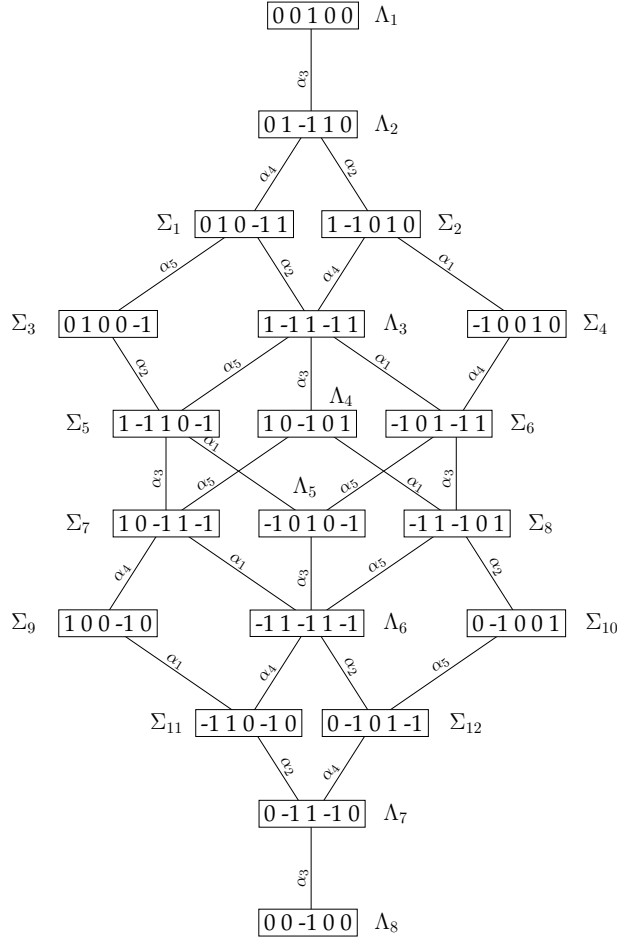

Figure 8: The weights of the **20** of $SL(6, \mathbb{R})$.

This approach makes it possible to extend this kind of analysis to any dimension. In order to show how it works, let us analyse the rank 4 orbits of the previous case; the Dynkin indices of the weights of the **20** of $SL(6, \mathbb{R})$ are shown in fig. 8. The rank 4 element corresponds to a bound state of the weights Λ_1 , Λ_4 , Λ_6 , Λ_7 . There are three possible independent bound states that can be written as $\Lambda_1 + \Lambda_4 + a\Lambda_6 + b\Lambda_7$ with $a, b = \pm 1$.¹² The stabilizers are listed in Table 15 as functions of a and b . The complexification of the

¹¹The real fundamental irreducible representation of $Sp(4, \mathbb{R})$ is the real spinor of $SO(3, 2)$.

¹²The two states with $a = \pm 1, b = \mp 1$ are not independent.

common	conjunction
$\Lambda_1, \Lambda_4, \Lambda_6, \Lambda_7$	$\Lambda_1 + \Lambda_4 + a\Lambda_6 + b\Lambda_7$
	$E_{\alpha_2+\alpha_3} - E_{-\alpha_3-\alpha_4}$
	$E_{\alpha_3+\alpha_4} - E_{-\alpha_2-\alpha_3}$
	$E_{\alpha_1+\alpha_2+\alpha_3} - aE_{-\alpha_3-\alpha_4-\alpha_5}$
	$E_{\alpha_3+\alpha_4+\alpha_5} - aE_{-\alpha_1-\alpha_2-\alpha_3}$
	$E_{\alpha_5} - aE_{-\alpha_1}$
	$E_{\alpha_1} - aE_{-\alpha_5}$
$H_{\alpha_2} - H_{\alpha_4}$	$E_{\alpha_1+\alpha_2+\alpha_3+\alpha_4} - bE_{-\alpha_2-\alpha_3-\alpha_4-\alpha_5}$
$H_{\alpha_1} - H_{\alpha_5}$	$E_{\alpha_2+\alpha_3+\alpha_4+\alpha_5} - bE_{-\alpha_1-\alpha_2-\alpha_3-\alpha_4}$
	$E_{\alpha_1+\alpha_2} - bE_{-\alpha_4-\alpha_5}$
	$E_{\alpha_4+\alpha_5} - bE_{-\alpha_1-\alpha_2}$
	$E_{\alpha_2} - abE_{-\alpha_4}$
	$E_{\alpha_4} - abE_{-\alpha_2}$
	$F_{\alpha_3}^{-ab} + abF_{\alpha_2+\alpha_3+\alpha_4}^{-ab}$
	$F_{\alpha_3}^{-ab} + bF_{\alpha_1+\alpha_2+\alpha_3+\alpha_4+\alpha_5}^{-ab}$

Table 15: Stabilizers of $\Lambda_1 + \Lambda_4 + a\Lambda_6 + b\Lambda_7$. The common stabilizers are the generators that annihilate each of the four weights separately, while the conjunction stabilizers are those that give a vanishing result acting on the particular combination of weights considered.

stabilizing algebra gives an $SL(3, \mathbb{C})$ with the following generators:

$$\begin{aligned}
H_{\beta_1} &= \frac{1}{2} \left[H_{\alpha_1} - H_{\alpha_5} + \sqrt{-ab} \left(F_{\alpha_2+\alpha_3+\alpha_4}^{-ab} - aF_{\alpha_1+\alpha_2+\alpha_3+\alpha_4+\alpha_5}^{-ab} \right) \right]; \\
H_{\beta_2} &= \frac{1}{2} \left[H_{\alpha_2} - H_{\alpha_4} - \sqrt{-ab} \left(F_{\alpha_3}^{-ab} + abF_{\alpha_2+\alpha_3+\alpha_4}^{-ab} \right) \right], \\
H_{\beta_3} &= \frac{1}{2} \left[H_{\alpha_4} - H_{\alpha_2} - \sqrt{-ab} \left(F_{\alpha_3}^{-ab} + abF_{\alpha_2+\alpha_3+\alpha_4}^{-ab} \right) \right], \\
H_{\beta_4} &= \frac{1}{2} \left[H_{\alpha_5} - H_{\alpha_1} + \sqrt{-ab} \left(F_{\alpha_2+\alpha_3+\alpha_4}^{-ab} - aF_{\alpha_1+\alpha_2+\alpha_3+\alpha_4+\alpha_5}^{-ab} \right) \right], \tag{5.6}
\end{aligned}$$

$$\begin{aligned}
E_{\beta_1} &= E_{\alpha_1} - aE_{-\alpha_5} - \sqrt{-ab} (E_{\alpha_1+\alpha_2+\alpha_3+\alpha_4} - bE_{-\alpha_2-\alpha_3-\alpha_4-\alpha_5}), \\
E_{\beta_2} &= E_{\alpha_2+\alpha_3} - E_{-\alpha_3-\alpha_4} + \sqrt{-ab} (E_{\alpha_2} - abE_{-\alpha_4}), \\
E_{\beta_3} &= E_{\alpha_3+\alpha_4} - E_{-\alpha_2-\alpha_3} + \sqrt{-ab} (E_{\alpha_4} - abE_{-\alpha_2}), \\
E_{\beta_4} &= E_{\alpha_5} - aE_{-\alpha_1} - \sqrt{-ab} (E_{\alpha_2+\alpha_3+\alpha_4+\alpha_5} - bE_{-\alpha_1-\alpha_2-\alpha_3-\alpha_4}), \tag{5.7}
\end{aligned}$$

$$\begin{aligned}
E_{-\beta_1} &= E_{\alpha_5} - aE_{-\alpha_1} + \sqrt{-ab}(E_{\alpha_2+\alpha_3+\alpha_4+\alpha_5} - bE_{-\alpha_1-\alpha_2-\alpha_3-\alpha_4}), \\
E_{-\beta_2} &= E_{\alpha_3+\alpha_4} - E_{-\alpha_2-\alpha_3} - \sqrt{-ab}(E_{\alpha_4} - abE_{-\alpha_2}), \\
E_{-\beta_3} &= E_{\alpha_2+\alpha_3} - E_{-\alpha_3-\alpha_4} - \sqrt{-ab}(E_{\alpha_2} - abE_{-\alpha_4}), \\
E_{-\beta_4} &= E_{\alpha_1} - aE_{-\alpha_5} + \sqrt{-ab}(E_{\alpha_1+\alpha_2+\alpha_3+\alpha_4} - bE_{-\alpha_2-\alpha_3-\alpha_4-\alpha_5}), \tag{5.8}
\end{aligned}$$

$$\begin{aligned}
E_{\beta_1+\beta_2} &= E_{\alpha_1+\alpha_2+\alpha_3} - aE_{-\alpha_3-\alpha_4-\alpha_5} - \sqrt{-ab}(E_{\alpha_1+\alpha_2} - bE_{-\alpha_4-\alpha_5}), \\
E_{\beta_3+\beta_4} &= E_{\alpha_3+\alpha_4+\alpha_5} - aE_{-\alpha_1-\alpha_2-\alpha_3} - \sqrt{-ab}(E_{\alpha_4+\alpha_5} - bE_{-\alpha_1-\alpha_2}), \\
E_{-\beta_1-\beta_2} &= E_{\alpha_3+\alpha_4+\alpha_5} - aE_{-\alpha_1-\alpha_2-\alpha_3} + \sqrt{-ab}(E_{\alpha_4+\alpha_5} - bE_{-\alpha_1-\alpha_2}), \\
E_{-\beta_3-\beta_4} &= E_{\alpha_1+\alpha_2+\alpha_3} - aE_{-\alpha_3-\alpha_4-\alpha_5} + \sqrt{-ab}(E_{\alpha_1+\alpha_2} - bE_{-\alpha_4-\alpha_5}). \tag{5.9}
\end{aligned}$$

By varying the values of a and b , one obtains two different real forms for the stabilizers, namely $SL(3, \mathbb{C})_{\mathbb{R}}$ and $SL(3, \mathbb{R}) \times SL(3, \mathbb{R})$, corresponding respectively to $a = b = \pm 1$ and $a = -b = \pm 1$ choices¹³. The two resulting real forms, $SL(3, \mathbb{C})_{\mathbb{R}}$ and $SL(3, \mathbb{R}) \times SL(3, \mathbb{R})$ of $SL(3, \mathbb{C})$, have the same signature, but they are discriminated by looking at the imaginary units appearing in the Chevalley basis (in particular, for $SL(3, \mathbb{C})_{\mathbb{R}}$ there are not imaginary units in the stabilizing algebra). Summarizing, the 4-weights bound state orbits are those given in (5.5a) and (5.5b). It should be stressed that, although in principle the independent bound states would have been three, only two orbits are present. One is the dyonic orbit, corresponding to a and b with opposite signs. The second orbit is related to the two combinations where a and b have the same sign. They are independent, but give rise to the *same* orbit, explaining the *absence* of stratification. The same behaviour is exhibited by the theories based on \mathbb{H}_s , extending this property to the whole family of theories based on \mathbb{C}_s , \mathbb{H}_s and \mathbb{O}_s .

It is interesting to compare the previous set of theories to magic $\mathcal{N} = 2$ and $\mathcal{N} = 4$ supergravity theories in $D = 4$ where, on the contrary, a rich stratification of orbits appears (for a comprehensive treatment, see [35]). To understand the basic factors marking such a difference it is worth to consider, as a representative example, the $\mathcal{N} = 2$ magic supergravity based on $\mathbf{J}_3^{\mathbb{R}}$, whose $D = 4$ U-duality group is $Sp(6, \mathbb{R})$, obtained uplifting the $F_{4(4)}$ three-dimensional theory. In this case, the 0-branes (black holes) belong to the $\mathbf{14}'$ (rank-3 antisymmetric skew-traceless) irreducible representation, whose highest weight, Λ_1 , is $\boxed{1 \ 0 \ 0}$. To construct the rank two orbit, we have to combine the highest weight with the weight Λ_4 identified by the Dynkin labels $\boxed{2 \ 0 \ -1}$. The possible independent bound states are thus $\Lambda_1 \pm \Lambda_4$. The rank two-orbits read

$$\frac{Sp(6, \mathbb{R})}{SO(1, 3) \times \mathbb{R}^4 \times \mathbb{R}} \tag{5.10}$$

and

$$\frac{Sp(6, \mathbb{R})}{SO(2, 2) \times \mathbb{R}^4 \times \mathbb{R}}, \tag{5.11}$$

¹³The subscript “ \mathbb{R} ” denotes the Lie algebra to be considered as an algebra over the reals.

corresponding to the combinations with the plus and minus sign, respectively. Thus, two non-isomorphic rank-2 orbits exist. The same splitting phenomenon takes place for the rank-three and rank-four cases, namely two rank-three orbits and three rank-four orbits are present. It is worth remarking that the maximal possible splitting is actually realised, since two and three are respectively the number of independent three- and four- charge bound states. The obtained stratification of orbits is not surprising, being related to the presence of weights of different lengths in the $\mathbf{14}'$, a property never encountered in the supergravity theories related to split composition algebras [33]. Indeed, the short weights are responsible for the change of compactness of some generators in the stabilizer when switching from one combination to the other, giving rise to the split of the orbits. In particular, in the case at hand, the conjunction stabilizer $F_{\alpha_2+\alpha_3}^\pm = E_{\alpha_2+\alpha_3} \pm E_{-\alpha_2-\alpha_3}$ appearing in the full set of stabilizer of Table 16 does the job.

common	conjunction	
Λ_1, Λ_4	$\Lambda_1 + \Lambda_4$	$\Lambda_1 - \Lambda_4$
$E_{2\alpha_1+2\alpha_2+\alpha_3}$	$F_{\alpha_2+\alpha_3}^-$	$F_{\alpha_2+\alpha_3}^+$
$E_{\alpha_1+2\alpha_2+\alpha_3}$		
$E_{\alpha_1+\alpha_2+\alpha_3}$	$E_{2\alpha_2+\alpha_3} - E_{-\alpha_3}$	$E_{2\alpha_2+\alpha_3} + E_{-\alpha_3}$
$E_{\alpha_1+\alpha_2}$		
$E_{\alpha_1} \quad E_{\alpha_2}$	$E_{\alpha_3} - E_{-2\alpha_2-\alpha_3}$	$E_{\alpha_3} + E_{-2\alpha_2-\alpha_3}$
H_{α_2}		
$E_{-\alpha_2}$		

Table 16: Stabilizers for the 2-weights bound states $\Lambda_1 \pm \Lambda_4$ in the $\mathbf{14}'$ of $Sp(6, \mathbb{R})$.

The previous considerations hold true not only for the uplifts of the $F_{4(4)}$ theory but also for its $SL(n, \mathbb{R})$ truncations. This is the case, for instance, of the three dimensional theory¹⁴ with $SL(3, \mathbb{R})$ obtained by truncating the Ehlers $SL(3, \mathbb{R})$. In this theory the 0-branes belong to the representation¹⁵ $\mathbf{6}$ that, containing again weights of two different lengths, induces the splitting of the orbits. The phenomenon is completely general, and an exhaustive treatment will be presented in a forthcoming paper [58].

An analysis of the other $\mathcal{N} = 2$ ($\mathbb{R} \oplus \mathbf{\Gamma}_{1,m-3}$ -based) and the $\mathcal{N} = 4$ ($\mathbb{R} \oplus \mathbf{\Gamma}_{5,m-3}$ -based) supergravity theories points out additional subtleties. In particular, since the U-duality symmetries do not occur in the split form, non-real weights are present in their representations. The reality properties of the weights depend on the real form of the algebra, and they are encoded in the corresponding Tits-Satake diagram. Non-real weights play here the same role as the short weights, giving rise in an analogous way to orbit

¹⁴Note that $F_{4(4)}$ embeds non-symmetrically and maximally two $SL(3, \mathbb{R})$'s, which are not on the same footing. The one yielding triplets and anti-triplets in the decomposition of the adjoint of $F_{4(4)}$ is the Ehlers group.

¹⁵This is nothing but the representation of $\mathbf{J}_3^{\mathbb{R}}$ with respect to its reduced structure group $SL(3, \mathbb{R})$. Indeed, $SL(3, \mathbb{R})$ is also the global (U-duality) symmetry of the $\mathcal{N} = 2$, $D = 5$ uplift of the $\mathcal{N} = 4$, $D = 3$ $F_{4(4)}$ theory.

splittings [33]. Let us explain the mechanism using as a guide the mentioned analysis of the rank-four orbits in the $\mathbf{20}$ of $SL(6, \mathbb{R})$. If the algebra had been $SU(3, 3)$ instead of $SL(6, \mathbb{R})$, the degeneracy between the two rank four orbits with $a = b = \pm 1$ would have been lifted, leaving three distinct rank four orbits, namely $SL(6, \mathbb{R})/[SU(3) \times SU(3)]$ for $a = b = 1$, $SL(6, \mathbb{R})/[SU(1, 2) \times SU(1, 2)]$ for $a = b = -1$ and $SL(6, \mathbb{R})/[SL(3, \mathbb{C})_{\mathbb{R}}]$ in the other cases (note that the first two cosets do not exist!).

The picture emerging from the previous discussion seems to point towards a precise statement: in absence of supersymmetry there is not splitting of orbits, while in non-maximal supergravity theories the orbit splitting can take place depending on the real form and on the relevant representations of the duality group.

6 Discussion and conclusions

We have analysed the magic non-supersymmetric theories based on split quaternions \mathbb{H}_s and split complex numbers \mathbb{C}_s . These theories can be obtained as $SL(2, \mathbb{R})$ and $SL(3, \mathbb{R})$ Ehlers truncations of maximal supergravity and are related to the $E_{7(7)}^{+++}$ and the $E_{6(6)}^{+++}$ very extended Kac-Moody algebras [25, 26]. We have generalised the procedure to $SL(n, \mathbb{R})$ Ehlers truncations (with $n > 3$) of the maximal supergravity giving rise to additional classes of non-supersymmetric theories, as well as to $SL(n, \mathbb{R})$ Ehlers truncations of non-maximal supergravity theories. It should be emphasised that our analysis involves not only the propagating degrees of freedom but also the $(D - 1)$ - and D -forms, in any dimension $D \geq 3$. Since the field strength of the $(D - 1)$ -forms are dual to mass parameters, our analysis also encodes massive deformation and gaugings. In some cases, the truncation generates theories that are obtained by very-extended Kac-Moody algebras of the form $[G_1 \times G_2]^{+++}$, that have been introduced in [29]. Finally, we have discussed properties of the duality orbits of extremal black-hole solutions of these theories.

An interesting issue is related to the embedding of the class of magic theories into perturbative string theory¹⁶. In [60], the magic exceptional supergravity based on \mathbf{J}_3^{\oplus} and with an $E_{8(-24)}$ symmetry in $D = 3$ has been constructed in $3 \leq D \leq 6$. In particular, the six-dimensional theory has been identified as the long wavelength limit of a certain compactification of Type IIB on $K3$. It is realised as a peculiar shift-orientifold [61–67] of the Type IIB, where the unoriented projection truncates the 5 tensor multiplets of the untwisted sector to 1 tensor multiplet and 4 hypermultiplets and the 16 twisted tensor multiplets to 8 tensor multiplets and 8 hypermultiplets. The introduction of 16 D5-branes to cancel anomalies provides 16 additional abelian vector multiplets, with gauge group $U(1)^{16}$. The momentum shift paired to the \mathbb{Z}_2 -orbifold involution defining the $K3$ prevents the introduction of D9-branes. The other D -dimensional models ($D < 6$) in the chain are obtained by reducing the six-dimensional theory on a $(6 - D)$ -torus. In particular, the magic octonionic four-dimensional theory with $E_{7(-25)}$ symmetry is thus obtained as a freely-acting orientifold of Type IIB on $K3 \times T^2$.

There also exist string-theory realizations of the complex and quaternionic magic theo-

¹⁶See also Sections 12 and 13 of [59].

ries in four dimensions. In [68], the theory defined by the algebra $J_3^{\mathbb{H}}$ has been built as an asymmetric shift-orbifold of the Type IIA string. In particular, starting from an (S-)dual pair of Type IIA theories compactified on T^4 in six dimensions and performing a suitable asymmetric shift-orbifold projection on T^2 [62–64, 67], one ends up with a *self dual* theory in four dimensions, exactly coincident with the magic theory. Interestingly, the theory is free of hypermultiplets and with the dilaton belonging to a vector multiplet. The *bosonic* massless spectrum includes the $\mathcal{N} = 2$ gravity multiplet coupled to 15 vector multiplets and perfectly coincides with the one of the $\mathcal{N} = 6$ pure supergravity, obtainable with analogous construction in terms of another self-dual theory. The 30 scalars, of course, parametrise the coset $SO^*(12)/U(6)$.

The same quaternionic magic model has been obtained in [69] as $\mathcal{N} = 2$ (non-geometric) compactifications of Type IIA, using a different asymmetric shift-orbifolds realised within the free fermionic construction [70, 71]. The procedure rests on adding a peculiar chiral twist that substitutes the extra gravitinos with fermions in the twin $\mathcal{N} = 6$ model, related to a simpler asymmetric shift projection. Again, these models are free of hypermultiplets with the dilaton belonging to a vector multiplet. Using an analogous procedure, the magic theory defined by $J_3^{\mathbb{C}}$ can be obtained as a projection from the $\mathcal{N} = 3$ theory coupled to 3 vector multiplets, realised again as an asymmetric shift-orbifold of the Type IIA with free fermions. The massless spectrum contains an $\mathcal{N} = 2$ supergravity coupled to 8 vector multiplets. The 18 scalars parametrise the coset $SU(3, 3)/SU(3) \times SU(3) \times U(1)$, the model is hyper-free and the dilaton is in a vector multiplet. It should be stressed that these compactifications have $(1, 4)$ supersymmetry on the world-sheet and do not correspond to Calabi-Yau compactifications, associated to $(2, 2)$ supersymmetry on the world-sheet. The quaternionic model can be uplifted to five dimensions and reduced on S^1 to three dimensions, while the complex model can be reduced to three dimensions but cannot be oxidised to higher dimensions because the involved moduli come from twisted sectors of the orbifold. As emerging from the previous discussion, it is clear that the embedding within string theory is not necessarily unique. For instance, besides the two realizations of the magic quaternionic theory in four dimensions, the five-dimensional magic quaternionic theory can also be obtained [60] as an S^1 compactification of a six dimensional orientifold of a corresponding Gepner model [72].

The situation is subtler for the magic non-supersymmetric theories, where quantum corrections are not protected. As seen, two are the “necessary” conditions: one is that the dilaton must factor out of the truncation algebra, the second is that the truncation algebra itself must be a sub-algebra of the perturbative T-duality symmetry. In general, it is not obvious that even if the two conditions are respected, the model can be seen as a perturbative truncation of a certain string model whose massless sector coincides with the non-truncated supergravity. Just to give a taste of the problem, let us consider one of the simplest models, the 8B theory in eight dimensions related to split quaternions. If realised in string theory, it should result as a truncation to eight dimensions of the ten dimensional Type IIB string, whose massless bosonic NS-NS sector coincides with the one of the IIB supergravity. Specifically, it contains the graviton, g_{MN} , the two form B_{MN} and the dilaton φ in the NS-NS sector and a scalar C_0 , a two-form C_{MN} and a self-dual

four form C_{MNPQ}^+ in the R-R sector. By compactifying on a two-torus down to eight dimensions, the spectrum can be organised in terms of representations of the geometric $SL(2)$ group. The truncated theory corresponds to keeping only the $SL(2)$ singlets. It amounts to have a non-supersymmetric theory with a massless spectrum consisting of the graviton $g_{\mu\nu}$, the dilaton φ , four additional scalars $\varphi_i, i = 1, \dots, 4$ and three two-forms. The scalars correspond to the internal part of the ten-dimensional two-forms B and C , to the volume of the two torus and to the surviving R-R scalar. The two forms are the survival spacetime components of the ten dimensional B and C and an additional two form coming from the combination of the internal components of the self-dual ten dimensional four-form. The question is whether the described remnant spectrum in eight dimensions is obtainable as a string theory projection of the Type IIB. In other words, we need a compactification on a manifold that is able to throw away the fermions and to project the rest on singlets of $SL(2, \mathbb{Z})$. The simplest natural action one could envisage, as in the magic supersymmetric cases, is a freely acting (Scherk-Schwarz) orbifold deformation (like that in [62–67]) combined with the action of a discrete (finite) subgroup commuting with, or stabilizing, the $SL(2, \mathbb{Z})$. The most promising attempt, a freely acting \mathbb{Z}_4 orbifold, does the truncation job but unfortunately does not exist at the level of perturbative string theory, since a modular invariant \mathbb{Z}_4 orbifold projection of Type IIB is not available in eight dimensions. We cannot suggest closer models nor give definite answers. As said, since we are singling out electric-magnetic duality symmetries, it is not at all guaranteed that a perturbative string theory model exists corresponding to these truncations. It could be that some reductions of this theory exist in lower dimensions but there are obstructions to oxidise them up to eight dimensions. Of course, it would also be very interesting to analyse non-perturbative completions of our models but, being non supersymmetric, the control over quantum corrections is unavoidably very limited.

Acknowledgements

L.R. would like to thank E. Bergshoeff and the Quantum Gravity group of the Rijksuniversiteit Groningen for their kind hospitality while this work was being completed. This work has been supported in part by the STaI “Uncovering Excellence” Grant of the University of Rome “Tor Vergata”, CUP E82L15000300005 and in part by “Sapienza” University of Rome.

References

- [1] E. Cremmer and B. Julia, “The N=8 Supergravity Theory. 1. The Lagrangian,” *Phys. Lett.* **80B** (1978) 48.
- [2] E. Cremmer and B. Julia, “The SO(8) Supergravity,” *Nucl. Phys. B* **159** (1979) 141.

- [3] C. M. Hull and P. K. Townsend, “Unity of superstring dualities,” Nucl. Phys. B **438** (1995) 109 [hep-th/9410167].
- [4] For a review, see *e.g.* J. H. Schwarz, “Lectures on superstring and M theory dualities: Given at ICTP Spring School and at TASI Summer School,” Nucl. Phys. Proc. Suppl. **55B** (1997) 1 [hep-th/9607201]; C. Vafa, “Lectures on strings and dualities,” hep-th/9702201.
- [5] H. Nicolai and H. Samtleben, “Maximal gauged supergravity in three-dimensions,” Phys. Rev. Lett. **86** (2001) 1686 [hep-th/0010076].
- [6] B. de Wit, H. Samtleben and M. Trigiante, “On Lagrangians and gaugings of maximal supergravities,” Nucl. Phys. B **655** (2003) 93 [hep-th/0212239].
- [7] B. de Wit, H. Samtleben and M. Trigiante, “The Maximal D=5 supergravities,” Nucl. Phys. B **716** (2005) 215 [hep-th/0412173].
- [8] B. de Wit, H. Samtleben and M. Trigiante, “Magnetic charges in local field theory,” JHEP **0509** (2005) 016 [hep-th/0507289].
- [9] H. Samtleben and M. Weidner, “The Maximal D=7 supergravities,” Nucl. Phys. B **725** (2005) 383 [hep-th/0506237].
- [10] P. C. West, “E(11) and M theory,” Class. Quant. Grav. **18** (2001) 4443 [hep-th/0104081].
- [11] I. Schnakenburg and P. C. West, “Kac-Moody symmetries of 2B supergravity,” Phys. Lett. B **517** (2001) 421 [hep-th/0107181].
- [12] I. Schnakenburg and P. C. West, “Massive IIA supergravity as a nonlinear realization,” Phys. Lett. B **540** (2002) 137 [hep-th/0204207].
- [13] F. Riccioni and P. C. West, “The E(11) origin of all maximal supergravities,” JHEP **0707** (2007) 063 [arXiv:0705.0752 [hep-th]].
- [14] E. A. Bergshoeff, I. De Baetselier and T. A. Nutma, “E(11) and the embedding tensor,” JHEP **0709** (2007) 047 [arXiv:0705.1304 [hep-th]].
- [15] I. Schnakenburg and P. C. West, “Kac-Moody symmetries of ten-dimensional non-maximal supergravity theories,” JHEP **0405** (2004) 019 [hep-th/0401196].
- [16] F. Riccioni, A. Van Proeyen and P. C. West, “Real forms of very extended Kac-Moody algebras and theories with eight supersymmetries,” JHEP **0805** (2008) 079 [arXiv:0801.2763 [hep-th]].
- [17] E. A. Bergshoeff, J. Gomis, T. A. Nutma and D. Roest, “Kac-Moody Spectrum of (Half-)Maximal Supergravities,” JHEP **0802** (2008) 069 [arXiv:0711.2035 [hep-th]].

- [18] M. Gunaydin, G. Sierra and P. K. Townsend, “Exceptional Supergravity Theories and the MAGIC Square,” *Phys. Lett.* **133B** (1983) 72.
- [19] M. Gunaydin, G. Sierra and P. K. Townsend, “The Geometry of N=2 Maxwell-Einstein Supergravity and Jordan Algebras,” *Nucl. Phys. B* **242** (1984) 244.
- [20] M. Gunaydin, G. Sierra and P. K. Townsend, “Gauging the d = 5 Maxwell-Einstein Supergravity Theories: More on Jordan Algebras,” *Nucl. Phys. B* **253** (1985) 573.
- [21] For a review, see S. Bellucci, “Proceedings, INFN-Laboratori Nazionali di Frascati School on the Attractor Mechanism on Supersymmetric Gravity and Black Holes (SAM 2009) : Frascati, Italy, 29 Jun - 3 Jul, 2009,” *Springer Proc. Phys.* **142** (2013) pp.1.
- [22] H. Freudenthal, “Lie groups in the foundations of geometry,” *Adv. Math.* **1** (1963) 145; J. Tits, “Algèbres alternatives, algèbres de Jordan et algèbres de Lie exceptionnelles. I. Construction,” (French), *Nederl. Akad. Wetensch. Proc. Ser. A* **69** (1966) 223; B. A. Rozenfeld, “Geometrical interpretation of the compact simple Lie groups of the class E ” (in Russian), *Dokl. Akad. Nauk. SSSR* **106** (1956) 600.
- [23] C. H. Barton and A. Sudbery, “Magic squares of Lie algebras,” [math/0001083 \[math-ra\]](#).
- [24] S. L. Cacciatori, B. L. Cerchiai and A. Marrani, “Squaring the Magic,” *Adv. Theor. Math. Phys.* **19** (2015) 923 [[arXiv:1208.6153 \[math-ph\]](#)].
- [25] F. Englert, L. Houart, A. Taormina and P. C. West, “The Symmetry of M theories,” *JHEP* **0309** (2003) 020 [[hep-th/0304206](#)].
- [26] A. Kleinschmidt, I. Schnakenburg and P. C. West, “Very extended Kac-Moody algebras and their interpretation at low levels,” *Class. Quant. Grav.* **21** (2004) 2493 [[hep-th/0309198](#)].
- [27] S. Ferrara, A. Marrani and M. Trigiante, “Super-Ehlers in Any Dimension,” *JHEP* **1211** (2012) 068 [[arXiv:1206.1255 \[hep-th\]](#)].
- [28] A. Marrani, E. Orazi and F. Riccioni, “Exceptional Reductions,” *J. Phys. A* **44** (2011) 155207 [[arXiv:1012.5797 \[hep-th\]](#)].
- [29] A. Kleinschmidt and D. Roest, “Extended Symmetries in Supergravity: The Semi-simple Case,” *JHEP* **0807** (2008) 035 [[arXiv:0805.2573 \[hep-th\]](#)].
- [30] E. Cremmer, B. Julia, H. Lu and C. N. Pope, “Higher dimensional origin of D = 3 coset symmetries,” [hep-th/9909099](#).
- [31] P. Breitenlohner, D. Maison and G. W. Gibbons, “Four-Dimensional Black Holes from Kaluza-Klein Theories,” *Commun. Math. Phys.* **120** (1988) 295.

- [32] H. Lu, C. N. Pope and K. S. Stelle, “Multiplet structures of BPS solitons,” *Class. Quant. Grav.* **15** (1998) 537 [hep-th/9708109].
- [33] A. Marrani, F. Riccioni and L. Romano, “Real weights, bound states and duality orbits,” *Int. J. Mod. Phys. A* **31** (2016) no.01, 1550218 [arXiv:1501.06895 [hep-th]].
- [34] S. Ferrara and M. Gunaydin, “Orbits of exceptional groups, duality and BPS states in string theory,” *Int. J. Mod. Phys. A* **13** (1998) 2075 [hep-th/9708025].
- [35] L. Borsten, M. J. Duff, S. Ferrara, A. Marrani and W. Rubens, “Small Orbits,” *Phys. Rev. D* **85** (2012) 086002 [arXiv:1108.0424 [hep-th]].
- [36] T. Springer, F. D. Veldkamp, “Octonions, Jordan Algebras and Exceptional Groups,” Springer, 2013.
- [37] B. de Wit, A. K. Tollsten and H. Nicolai, “Locally supersymmetric $D = 3$ nonlinear sigma models,” *Nucl. Phys. B* **392** (1993) 3 [hep-th/9208074].
- [38] P. Henry-Labordere, B. Julia and L. Paulot, “Borcherds symmetries in M theory,” *JHEP* **0204** (2002) 049 [hep-th/0203070].
- [39] A. Iqbal, A. Neitzke and C. Vafa, “A Mysterious duality,” *Adv. Theor. Math. Phys.* **5** (2002) 769 [hep-th/0111068].
- [40] P. C. West, “Very extended $E(8)$ and $A(8)$ at low levels, gravity and supergravity,” *Class. Quant. Grav.* **20** (2003) 2393 [hep-th/0212291].
- [41] M. Goroff and J. H. Schwarz, “ D -dimensional Gravity in the Light Cone Gauge,” *Phys. Lett.* **127B** (1983) 61.
- [42] P. Henry-Labordere, B. Julia and L. Paulot, “Real Borcherds superalgebras and M theory,” *JHEP* **0304** (2003) 060 [hep-th/0212346].
- [43] M. Gunaydin, K. Koepsell and H. Nicolai, “Conformal and quasiconformal realizations of exceptional Lie groups,” *Commun. Math. Phys.* **221** (2001) 57 [hep-th/0008063].
- [44] M. Gunaydin and O. Pavlyk, “Quasiconformal Realizations of $E(6)(6)$, $E(7)(7)$, $E(8)(8)$ and $SO(n+3, m+3)$, $N \geq 4$ Supergravity and Spherical Vectors,” *Adv. Theor. Math. Phys.* **13** (2009) no.6, 1895 [arXiv:0904.0784 [hep-th]].
- [45] S. Ferrara and J. M. Maldacena, “Branes, central charges and U duality invariant BPS conditions,” *Class. Quant. Grav.* **15** (1998) 749 [hep-th/9706097].
- [46] L. Borsten, D. Dahanayake, M. J. Duff, S. Ferrara, A. Marrani and W. Rubens, “Observations on Integral and Continuous U-duality Orbits in $N=8$ Supergravity,” *Class. Quant. Grav.* **27** (2010) 185003 [arXiv:1002.4223 [hep-th]].
- [47] S. Ferrara and M. Gunaydin, “Orbits and Attractors for $N=2$ Maxwell-Einstein Supergravity Theories in Five Dimensions,” *Nucl. Phys. B* **759** (2006) 1 [hep-th/0606108].

- [48] L. Borsten, M. J. Duff, S. Ferrara and A. Marrani, “Freudenthal Dual Lagrangians,” *Class. Quant. Grav.* **30** (2013) 235003 [arXiv:1212.3254 [hep-th]].
- [49] G. Bossard, “Octonionic black holes,” *JHEP* **1205** (2012) 113 [arXiv:1203.0530 [hep-th]].
- [50] C. Gao, X. Chen and Y. G. Shen, “Quintessence and phantom emerging from the split-complex field and the split-quaternion field,” *Gen. Rel. Grav.* **48** (2016) no.1, 11 [arXiv:1501.03220 [gr-qc]].
- [51] H. Freudenthal, “Beziehungen der E7 und E8 zur oktavenebene I-II,” *Nederl. Akad. Wetensch. Proc. Ser.* **57** (1954) 218–230; H. Freudenthal, “Beziehungen der E7 und E8 zur oktavenebene IX,” *Nederl. Akad. Wetensch. Proc. Ser.* **A62** (1959) 466–474; K. Meyberg, “Eine theorie der freudenthalschen tripelsysteme. i, ii,” *Nederl. Akad. Wetensch. Proc. Ser.* **A71** (1968).
- [52] M. Sato and T. Kimura, “A classification of irreducible prehomogeneous vector spaces and their relative invariants,” *Nagoya Math. J.* **65** (1977) 1.
- [53] V. G. Kac, “Some Remarks on Nilpotent Orbits,” *J. of Algebra* **64** (1980) 190.
- [54] H. Bermudez, S. Garibaldi and V. Larsen, “Linear preservers and representations with a 1-dimensional ring of invariants,” *Trans. Am. Math. Soc.* **366** (2014) no.9, 4755 [arXiv:1204.2840 [math.RT]].
- [55] S. Garibaldi and R. Guralnick, “Simple groups stabilizing polynomials,” *Forum of Mathematics, Pi* (2015), vol. 3, e3 (41 pages) [arXiv:1309.6611 [math.GR]].
- [56] J. C. Ferrar, “Strictly Regular Elements in Freudenthal Triple Systems,” *Trans. Am. Math. Soc.* **174** (1972) 313.
- [57] S. Krutelevich, “Jordan algebras, exceptional groups, and Bhargava composition,” *J. Algebra* **314** (2007) no. 2, 924–977, arXiv:math/0411104.
- [58] A. Marrani, G. Pradisi, F. Riccioni and L. Romano, in preparation.
- [59] M. Gunaydin, “Lectures on Spectrum Generating Symmetries and U-duality in Supergravity, Extremal Black Holes, Quantum Attractors and Harmonic Superspace,” *Springer Proc. Phys.* **134** (2010) 31. [arXiv:0908.0374 [hep-th]].
- [60] M. Bianchi and S. Ferrara, “Enriques and Octonionic Magic Supergravity Models,” *JHEP* **0802** (2008) 054 [arXiv:0712.2976 [hep-th]].
- [61] For a review, see *e.g.* C. Angelantonj and A. Sagnotti, “Open strings,” *Phys. Rept.* **371** (2002) 1 Erratum: [*Phys. Rept.* **376** (2003) no.6, 407] [hep-th/0204089].
- [62] R. Rohm, “Spontaneous Supersymmetry Breaking in Supersymmetric String Theories,” *Nucl. Phys. B* **237** (1984) 553.

- [63] C. Kounnas and M. Porrati, “Spontaneous Supersymmetry Breaking in String Theory,” Nucl. Phys. B **310** (1988) 355.
- [64] E. Kiritsis and C. Kounnas, “Perturbative and nonperturbative partial supersymmetry breaking: $N=4 \rightarrow N=2 \rightarrow N=1$,” Nucl. Phys. B **503** (1997) 117 [hep-th/9703059].
- [65] I. Antoniadis, E. Dudas and A. Sagnotti, “Supersymmetry breaking, open strings and M theory,” Nucl. Phys. B **544** (1999) 469 [hep-th/9807011].
- [66] I. Antoniadis, G. D’Appollonio, E. Dudas and A. Sagnotti, “Partial breaking of supersymmetry, open strings and M theory,” Nucl. Phys. B **553** (1999) 133 [hep-th/9812118].
- [67] C. Vafa and E. Witten, “Dual string pairs with $N=1$ and $N=2$ supersymmetry in four-dimensions,” Nucl. Phys. Proc. Suppl. **46** (1996) 225 [hep-th/9507050].
- [68] A. Sen and C. Vafa, “Dual pairs of type II string compactification,” Nucl. Phys. B **455** (1995) 165 [hep-th/9508064].
- [69] Y. Dolivet, B. Julia and C. Kounnas, “Magic $N=2$ supergravities from hyper-free superstrings,” JHEP **0802** (2008) 097 [arXiv:0712.2867 [hep-th]].
- [70] I. Antoniadis, C. P. Bachas and C. Kounnas, “Four-Dimensional Superstrings,” Nucl. Phys. B **289** (1987) 87.
- [71] H. Kawai, D. C. Lewellen and S. H. H. Tye, “Construction of Fermionic String Models in Four-Dimensions,” Nucl. Phys. B **288** (1987) 1.
- [72] C. Angelantonj, M. Bianchi, G. Pradisi, A. Sagnotti and Y. S. Stanev, “Comments on Gepner models and type I vacua in string theory,” Phys. Lett. B **387** (1996) 743 [hep-th/9607229].