

ON THE LONG-TIME ASYMPTOTIC OF THE MODIFIED CAMASSA-HOLM EQUATION WITH NONZERO BOUNDARY CONDITIONS IN SPACE-TIME SOLITONIC REGIONS

JIN-JIE YANG, SHOU-FU TIAN*, AND ZHI-QIANG LI

ABSTRACT. We investigate the long-time asymptotic behavior for the Cauchy problem of the modified Camassa-Holm (mCH) equation with nonzero boundary conditions in different regions

$$m_t + ((u^2 - u_x^2)m)_x = 0, \quad m = u - u_{xx}, \quad (x, t) \in \mathbb{R} \times \mathbb{R}^+, \\ u(x, 0) = u_0(x), \quad \lim_{x \rightarrow \pm\infty} u_0(x) = 1, \quad u_0(x) - 1 \in H^{4,1}(\mathbb{R}),$$

where $m(x, t = 0) := m_0(x)$ and $m_0(x) - 1 \in H^{2,1}(\mathbb{R})$. Through spectral analysis, the initial value problem of the mCH equation is transformed into a matrix RH problem on a new plane (y, t) , and then using the $\bar{\partial}$ nonlinear steepest descent method, we analyze the different asymptotic behaviors of the four regions divided by the interval of $\xi = y/t$ on plane $\{(y, t) | y \in (-\infty, +\infty), t > 0\}$. There is no steady-state phase point corresponding to the regions $\xi \in (-\infty, -1/4) \cup (2, \infty)$. We prove that the solution of mCH equation is characterized by N -soliton solution and error on these two regions. In $\xi \in (-1/4, 0)$ and $\xi \in (0, 2)$, the phase function $\theta(z)$ has eight and four steady-state phase points, respectively. We prove that the soliton resolution conjecture holds, that is, the solution of the mCH equation can be expressed as the soliton solution on the discrete spectrum, the leading term on the continuous spectrum, and the residual error. Our results also show that soliton solutions of the mCH equation with nonzero condition boundary are asymptotically stable.

CONTENTS

1. Introduction	2
2. Spectral analysis and eigenfunctions	5
2.1. Lax pairs	5
2.2. The eigenfunctions	6
2.3. Scattering matrix	8
2.4. Construction of Riemann-Hilbert problem	9
3. Distribution of phase points and symbol table	13
4. Deformation of RH problem for $\xi > 2$ and $\xi < -1/4$	17
4.1. Contour deformation	21
4.2. Decomposition of mixed RH problem	27

2000 *Mathematics Subject Classification.* 35Q55, 35Q15, 35C20.

Key words and phrases. The modified Camassa-Holm equation, long-time asymptotics, soliton resolution, Riemann-Hilbert problem, $\bar{\partial}$ -steepest descent method.

*Corresponding author(sftian@cumt.edu.cn, shoufu2006@126.com).

4.3. Asymptotic of N -soliton solution	28
4.4. The small-norm RH problem for error function	32
4.5. Analysis on pure $\bar{\partial}$ -problem	34
5. Deformation of RH problem for $\xi \in (-1/4, 0)$ and $\xi \in (0, 2)$	37
5.1. Contour deformation	38
5.2. Decomposition of the mixed RH problem	43
5.3. Analysis on pure RH problem	44
5.4. The small-norm RH problem	51
5.5. Analysis on pure $\bar{\partial}$ -problem	54
6. Long-time asymptotic behaviors	57
Acknowledgements	59
Appendix A. The proof of Proposition 5.11	59
A.1. Local model for $\xi \in (0, 2)$	59
A.2. Local model for $\xi \in (-1/4, 0)$	63
References	65

1. INTRODUCTION

The Camassa-Holm (CH) equation is an integrable nonlinear dispersion equation in the sense of having Lax representations [12, 13]

$$m_t + (um)_x + u_x m = 0, \quad m := u - u_{xx}, \quad (1.1)$$

which can be used to describe the unidirectional propagation of shallow water waves on a flat bottom and has a rich mathematical structure, which has attracted widespread attention in [18, 43]. In particular, Boutet and Shepelsky in [8] developed the inverse scattering theory to study the long-time asymptotic behavior of the solution of the CH equation (1.1) based on the nonlinear steepest descent method [27] by constructing the matrix Riemann-Hilbert (RH) problem [2], including Cauchy problem and initial-boundary value problem in [4, 6, 9, 10]. Also the method is widely applied to other integrable systems to study soliton solutions and asymptotic solutions of initial value problems and initial-boundary value problems [39, 61–63, 65, 66].

On the other hand, the CH equation (1.1) has a remarkable feature with fast decay initial value, which has weak solution and orbital stability [48, 59]. The CH equation has smooth soliton solution with non-zero dispersion term κu_x under the condition of fast decay initial value

$$m_t + ((u^2 - u_x^2)m)_x + \kappa u_x = 0, \quad m := u - u_{xx}, \quad (1.2)$$

where $\kappa > 0$ represents the effect of the linear dispersion, which is also called mCH equation [17, 51]. Under the initial value of weighted Sobolev space supporting solitons, Fan's team [69] proved the soliton resolution conjecture of the mCH equation with fast decaying initial value, and gave the asymptotic stability of the soliton solution. It is worth noting that for another version of the mCH equation without nonlinear dispersion term κu_x , which is derived from some literatures, e.g., [67] and references therein.

Specifically, in 2009, Novikov classified integrable equations by utilizing perturbation symmetry methods [56]

$$(1 - \partial_x^2) u_t = F(u, u_x, u_{xx}, \dots), \quad u = u(x, t), \quad (1.3)$$

where F is a homogeneous differential polynomial over \mathbb{C} (also [55]). Among a series of equations presented by Novikov, equation (32) in [56] is the second cubic nonlinear equation with the form (also called the modified Camassa-Holm (mCH) equation)

$$m_t + ((u^2 - u_x^2)m)_x = 0, \quad m := u - u_{xx}, \quad (1.4)$$

which has equivalent form given by Fokas in [36] (also see [37, 57]). Shiff regarded equation (1.4) as the duality of the modified Korteweg-de Vries (mKdV) equation, and gave the Lax pair of (1.4) based on the Lax pair of mKdV equation in [60]. An equivalent Lax pair for (1.4) was proposed by Qiao in [58], thus the mCH equation is also called the Fokas-Olver-Rosenau-Qiao (FORQ) equation in [41]. The mCH equation (1.4) has an interesting feature, that is, it has peakon solution [40]. The dynamic stability and the stability of peakons were studied in [47, 59]. Chang and Szmigielski studied multipeakon solutions by using inverse spectrum method [15]. Besides, there are many results about mCH equation, including local well posedness [16, 17, 37, 49], wave breaking mechanism [40], algebraic geometric quasi-periodic solutions [41], global weak solutions [38], Hamiltonian structure and Liouville integrability of peak systems [1, 13, 40, 57]. In terms of asymptotic solution analysis, the asymptotic analysis of the dispersionless CH equation (1.1) in the zero background (where the spectrum is completely discrete) requires different tools [33–35], because the inverse scattering method requires the spatial equation of the Lax pair related to the CH equation to have a continuous spectrum. For the similar situation of the mCH equation (1.4), Boutet, Karpenko, and Shepelsky developed the RH method to study the Cauchy problem of the mCH equation under the non-zero background [5], and studied the long-time asymptotic behavior of the solution in different regions [11] by using the classical nonlinear steepest descent method.

Compared with equations (1.2) and (1.4), the significantly different feature is that our work considers the version of the mCH equation (1.4) without dispersion term κu_x , which leads to the fact that the mCH equation (1.4) has only peakon solutions and no smooth soliton solution when it has an attenuation initial value. Therefore, in order to study whether the mCH equation (1.4) has similar characteristics, soliton resolution conjecture, to the mCH equation (1.2) with dispersion term κu_x and fast decaying initial value, we consider the initial value of finite density, which is also one of the main motivations of this work, that is, to study the long-time asymptotic behavior of the solution of the mCH equation (1.4) in different soliton regions.

Recently, an asymptotic analysis method, the so-called $\bar{\partial}$ -steepest descent method, was proposed by McLaughlin and Miller in [53, 54] to investigate the oscillation RH problem. Compared with the classical nonlinear steepest descent method, the advantage lies in improving the error accuracy on the one hand, and avoiding the complex norm estimation on the other hand. This method has been used to solve the asymptotic solution analysis of the initial value problem of nonlinear Schrödinger (NLS) equation without soliton since it was proposed in [31]. Subsequently, the soliton resolution conjecture of focusing NLS equation fast decay initial value was solved by $\bar{\partial}$ -steepest descent method from the perspective of integrable system [3]. The defocusing NLS equation with finite density initial value also

had similar results and [19] gave the asymptotic stability of the N -soliton solution. In addition, some progress has been made in proving the conjecture of soliton resolution of other nonlinear integrable models, including modified CH equation [69], short-pulse equation [68], Fokas-Lenells equation [14], Wadati-Konno-Ichikawa equation [46] and other equations.

A recent work by Boutet de monvel, Karpenko and Shepelsky in [11] investigated the long-time asymptotic solutions of Cauchy problem for the mCH equation with nonzero zero boundary conditions

$$m_t + ((u^2 - u_x^2)m)_x = 0, \quad m := u - u_{xx}, \quad t > 0, \quad -\infty < x < +\infty, \quad (1.5a)$$

$$u(x, 0) = u_0(x), \quad u_0(x) \rightarrow 1, \quad x \rightarrow \pm\infty, \quad (1.5b)$$

in the absence of the discrete spectrum based on the classical nonlinear steepest descent method, where $u_0(x) - 1 \in H^{4,1}(\mathbb{R})$. Subsequently, Yang, Fan and Liu [70] studied the existence of the global solution of the mCH equation (1.5) based on the inverse scattering theory. The purpose of our work is to study the long-time asymptotic behavior of the solution of the mCH equation (1.5) under the condition of finite density initial value $m_0(x) - 1 \in H^{2,1}(\mathbb{R})$ and the presence of discrete spectrum, based on the work [11] and in combination with the $\bar{\partial}$ -steepest descent method. Furthermore, we will prove that the soliton resolution conjecture of the mCH equation is also valid under the initial value condition of finite density.

As in [5], the mCH equation (1.5) with nonzero zero boundary conditions can be transformed into zero background under the new function $q := q(x, t)$ by

$$u(x, t) = q(x - t, t) + 1. \quad (1.6)$$

Then the mCH equation is

$$\check{m}_t + (\check{\omega}\check{m})_x = 0, \quad (1.7a)$$

$$\check{m} := q - q_{xx} + 1, \quad (1.7b)$$

$$\check{\omega} := q^2 - q_x^2 + 2q. \quad (1.7c)$$

In what follows, we will study long-time asymptotic behavior of mCH equation (1.7) with zero background $q(x, 0) := q_0(x) \rightarrow 0$ as $x \rightarrow \pm\infty$ and the initial data $\check{m}_0 - 1 \in H^{2,1}(\mathbb{R})$.

The soliton resolution conjecture can generally be expressed as that the evolution of the general initial data of globally well posed nonlinear dispersion equations will be decomposed into a finite soliton plus a dispersive radiation component. For most nonlinear dispersion equations, it is an open and very active research field [20, 50, 52]. The interesting point is that soliton resolution is better understood in integrable systems, and the solution provided by RH problem is more accurate than that obtained by pure analytic techniques [21, 24, 26]. Although [11] gives the asymptotic behavior of the solution of the mCH equation under non-zero boundary conditions from the classical nonlinear steepest descent method, we will further consider the asymptotic behavior of the solution of the mCH equation under non-zero boundary conditions in different regions from the perspective of $\bar{\partial}$ -nonlinear steepest descent method, and verify the validity of the soliton resolution conjecture.

The basic framework of this work: In Section 2, we do spectral analysis of the mCH equation under the initial value condition of finite density, and establish the analytical, asymptotic and symmetric

properties of the eigenfunctions and scattering coefficients. In addition, the RH problem corresponding to the mCH are established with finite density initial value (1.5b). Section 3 mainly considers the properties of the phase function $\theta(z)$, including the distribution of steady-state phase points and the symbol table that affects the attenuation of the oscillation terms $e^{\pm 2it\theta(z)}$.

In Section 4, the decomposition of RH problem on regions $\xi \in (-\infty, -1/4)$ and $\xi \in (2, \infty)$ depends on the change of the symbol table in Fig.2 of the phase function discussed in Section 3, corresponding to the absence of steady-state phase points. Section 4.1 mainly removes the jump of $M^{(1)}(z)$ on the real axis \mathbb{R} , and analyzes the attenuation region of the imaginary part of the phase function to prepare for continuous extension. In Section 4.2, the second transformation obtains a new matrix-valued function $M^{(2)}(z)$ corresponding to the mixed RH problem 4.6, which includes soliton component and pure $\bar{\partial}$ -problem. Pure soliton component $M^{(rhp)}(z)$ satisfied RH problem 4.7 is considered, corresponding to RH problem 4.6 with $\bar{\partial}R^{(2)}(z) \equiv 0$ discussed in Section 4.3. The error function $M^{(err)}(z)$ satisfies RH problem 4.13 solved by small-norm RH problem presented in Section 4.4. In the last Subsection 4.5, we discuss the contribution of pure RH problem to the solution of mCH equation.

In Section 5, the decomposition of RH problem on regions $\xi \in (-1/4, 0)$ and $\xi \in (0, 2)$ depends on the change of the symbol table in Fig.2 of the phase function discussed in Section 3, corresponding to eight steady-state phase points and four steady-state phase points, respectively. Similar to Section 4, we make a series of deformations to the original RH problem, and finally turn it into a solvable RH problem. The difference from Section 4 is that the steady-state phase points appear, and the contribution of the steady-state phase points to the solution of the mCH equation needs to be handled carefully, which is reflected in Appendix A. In Section 6, we summarize the results corresponding to the four cases, and give the different properties of the solution of the mCH equation under the initial value condition of finite density.

2. SPECTRAL ANALYSIS AND EIGENFUNCTIONS

This section will briefly review the spectral analysis in [5] reported by Boutet de Monvel, Karpenko and Shepelsky and make appropriate adjustments to facilitate the subsequent long-time asymptotic analysis.

2.1. Lax pairs. The Lax representation of the mCH equation (1.4) has the following form in [58]

$$\Phi_x = X_0\Phi, \quad \Phi_x = T_0\Phi, \quad (2.1)$$

where $\Phi := \Phi(x, t, \lambda)$, $X_0 := X_0(x, t, \lambda)$, and $T_0 := T_0(x, t, \lambda)$ with

$$X_0 = \frac{1}{2} \begin{pmatrix} -1 & \lambda m \\ -\lambda m & 1 \end{pmatrix}, \quad m := u - u_{xx},$$

$$T_0 = \begin{pmatrix} \lambda^{-2} + \frac{u^2 - u_x^2}{2} & -\lambda^{-1}(u - u_x) - \frac{\lambda(u^2 - u_x^2)m}{2} \\ \lambda^{-1}(u + u_x) + \frac{\lambda(u^2 - u_x^2)m}{2} & -\lambda^{-2} - \frac{u^2 - u_x^2}{2} \end{pmatrix},$$

from which one obtains a new Lax representation under the transformation (1.6)

$$\Phi_x = X_1 \Phi, \quad (2.2a)$$

$$\Phi_t = T_1 \Phi, \quad (2.2b)$$

where the coefficients $X_1 := X_1(x, t, \lambda)$ and $T_1 := T_1(x, t, \lambda)$ are defined by

$$X_1 = \frac{1}{2} \begin{pmatrix} -1 & \lambda \check{m} \\ -\lambda \check{m} & 1 \end{pmatrix}, \quad \check{m} := q - q_{xx} + 1, \quad \check{\omega} := q^2 - q_x^2 + 2q, \quad (2.3a)$$

$$T_1 = \begin{pmatrix} \lambda^{-2} + \frac{\check{\omega}}{2} & -\lambda^{-1}(q - q_x + 1) - \frac{\lambda \check{\omega} \check{m}}{2} \\ \lambda^{-1}(q + q_x + 1) + \frac{\lambda \check{\omega} \check{m}}{2} & -\lambda^{-2} - \frac{\check{\omega}}{2} \end{pmatrix}. \quad (2.3b)$$

Then the mCH equation (1.7) can be directly calculated from the compatibility condition $T_{1,t} - X_{1,x} + [T_1, X_1] = 0$, where the operator $[A, B] = AB - BA$. By observing the spectral problem (2.3a) of mCH equation, it is found that there are two spectral singularities, $\lambda = 0$ and $\lambda = \infty$, respectively. In order to control the asymptotic behavior, we need to discuss them respectively.

As $\lambda \rightarrow \infty$, we introduce the transformation

$$\Psi(x, t, \lambda) = D(\lambda) \Phi(x, t, \lambda), \quad (2.4)$$

where $D(\lambda)$ is the eigenvector matrix with

$$D(\lambda) = \begin{pmatrix} 1 & -\frac{1}{1+\sqrt{1-\lambda^2}} \\ -\frac{1}{1+\sqrt{1-\lambda^2}} & 1 \end{pmatrix},$$

to transform the Lax pairs (2.2) into

$$\Psi_x(x, t, \lambda) + P_x \Psi(x, t, \lambda) = X_2 \Psi(x, t, \lambda), \quad (2.5a)$$

$$\Psi_t(x, t, \lambda) + P_t \Psi(x, t, \lambda) = T_2 \Psi(x, t, \lambda), \quad (2.5b)$$

where $X_2 = X_2(x, t, \lambda)$ and $T_2 = T_2(x, t, \lambda)$ are given by

$$\begin{aligned} X_2 &= \frac{\lambda(\check{m} - 1)}{2\sqrt{1-\lambda^2}} \begin{pmatrix} 0 & 1 \\ -1 & 0 \end{pmatrix} + \frac{\check{m} - 1}{2\sqrt{1-\lambda^2}} \sigma_3, \\ T_2 &= \frac{i}{2\sqrt{1-\lambda^2}} \left(\lambda \check{\omega}(\check{m} - 1) + \frac{2q}{\lambda} \right) \sigma_2 + \frac{q_x}{\lambda} \sigma_1 - \frac{1}{\sqrt{1-\lambda^2}} \left(q + \frac{1}{2}(\check{m} - 1)\check{\omega} \right) \sigma_3, \\ P &:= P(x, t, \lambda) = p(x, t, \lambda) \sigma_3, \text{ with} \\ p(x, t, \lambda) &= -\frac{1}{2} \sqrt{1-\lambda^2} \left(\int_x^{+\infty} (\check{m}(\xi, t) - 1) d\xi - \frac{1}{2}x + \frac{1}{\lambda^2}t \right). \end{aligned}$$

2.2. The eigenfunctions. The Lax pairs in form (2.5) allows us to determine the special solution with good control behavior through the relevant integral equation. Indeed, introducing the transformation $\tilde{\Psi}(z) = \tilde{\Psi}(x, t, z)$

$$\tilde{\Psi}(z) = \Psi(z) e^P, \quad (2.6)$$

yields that

$$\tilde{\Psi}_x(z) + [P_x, \tilde{\Psi}(z)] = X_2 \tilde{\Psi}(z), \quad (2.7a)$$

$$\tilde{\Psi}_t(z) + [P_t, \tilde{\Psi}(z)] = T_2 \tilde{\Psi}(z). \quad (2.7b)$$

As $x \rightarrow \infty$, the systems (2.7) are determined by the Volterra integral equations

$$\begin{aligned} \tilde{\Psi}_+(x, t, \lambda) &= I - \int_x^{+\infty} e^{\frac{\sqrt{1-\lambda^2}}{2} \int_x^\xi \check{m}(\eta, t) d\eta \sigma_3} X_2(\xi, t, \lambda) \tilde{\Psi}_+(\xi, t, \lambda) e^{-\frac{\sqrt{1-\lambda^2}}{2} \int_x^\xi \check{m}(\eta, t) d\eta \sigma_3} d\xi, \\ \tilde{\Psi}_-(x, t, \lambda) &= I + \int_{-\infty}^x e^{\frac{\sqrt{1-\lambda^2}}{2} \int_x^\xi \check{m}(\eta, t) d\eta \sigma_3} X_2(\xi, t, \lambda) \tilde{\Psi}_-(\xi, t, \lambda) e^{-\frac{\sqrt{1-\lambda^2}}{2} \int_x^\xi \check{m}(\eta, t) d\eta \sigma_3} d\xi, \end{aligned} \quad (2.8)$$

where $\tilde{\Psi}_\pm \equiv \tilde{\Psi}_\pm(x, t, \lambda)$ are also called Jost functions. In order to eliminate the multivaluence of functions in exponential functions in (2.8), the following transformation is further introduced

$$\lambda^2 = 4k^2 + 1,$$

then the exponential functions in (2.8) become $e^{\pm ik \int_x^\xi \check{m}(\eta, t) d\eta \sigma_3}$. Also the coefficient matrices X_2 and T_2 have the following new forms

$$\begin{aligned} X_2(x, t, k) &= \frac{\check{m} - 1}{2} \left(\frac{1}{2ik} \begin{pmatrix} 1 & 0 \\ 0 & -1 \end{pmatrix} + \frac{\lambda(k)}{2ik} \begin{pmatrix} 0 & 1 \\ -1 & 0 \end{pmatrix} \right), \\ T_2(x, t, k) &= \frac{1}{4k} \left(\lambda(k) \check{\omega}(\check{m} - 1) + \frac{2q}{\lambda(k)} \right) \sigma_2 + \frac{q_x}{\lambda(k)} \sigma_1 - \frac{1}{2ik} \left(q + \frac{1}{2}(\check{m} - 1)\check{\omega} \right) \sigma_3. \end{aligned}$$

It is observed that the new spectral parameter k on which the coefficient matrices X_2 and T_2 depend are not rational because of the existence of $\lambda(k)$, which is also a great difference between the mCH equation and CH equation. In order to avoid discussing on the Riemann surface $\lambda^2 = 4k^2 + 1$, we introduce a new spectral parameter z , then both λ and k are single valued functions of z with

$$\lambda = -\frac{1}{2} \left(z + \frac{1}{z} \right), \quad k = \frac{1}{4} \left(z - \frac{1}{z} \right). \quad (2.9)$$

Now combining the transformation (2.9) with the expressions of $p(x, t, \lambda)$ and X_2 obtains

$$p(x, t, z) = -\frac{i(z^2 - 1)}{4z} \left(\int_x^{+\infty} (\check{m}(\xi, t) - 1) d\xi - x + \frac{8z^2}{(z^2 + 1)^2} t \right), \quad (2.10)$$

$$X_2(x, t, z) = \frac{i(z^2 + 1)(\check{m} - 1)}{2(z^2 - 1)} \begin{pmatrix} 0 & 1 \\ -1 & 0 \end{pmatrix} - \frac{iz(\check{m} - 1)}{z^2 - 1} \begin{pmatrix} 1 & 0 \\ 0 & -1 \end{pmatrix}, \quad (2.11)$$

from which we obtain the new form of Volterra integral equations

$$\tilde{\Psi}_\pm(x, t, z) = I + \int_{\pm\infty}^x e^{\frac{i(z^2-1)}{4z} \int_x^\xi \check{m}(\eta, t) d\eta \sigma_3} X_2(\xi, t, z) \tilde{\Psi}_\pm(\xi, t, z) e^{-\frac{i(z^2-1)}{4z} \int_x^\xi \check{m}(\eta, t) d\eta \sigma_3} d\xi. \quad (2.12)$$

Applying the Neumann series expansions for the solutions of $\tilde{\Psi}_\pm(x, t, z)$ in (2.12), we can investigate the analytic and asymptotic properties of eigenfunctions $\tilde{\Psi}_\pm(x, t, z)$ by analogy with the case of the CH equation [7, 8]. As the results reported in [5], we obtain the following proposition.

Proposition 2.1. *The eigenfunctions $\tilde{\Psi}_{\pm}(x, t, z)$ have the following properties:*

- ▶ *The eigenfunctions $\tilde{\Psi}_{-,1}$ and $\tilde{\Psi}_{+,2}$ are analytic in $\mathbb{C}^+ = \{z \in \mathbb{C} \mid \text{Im } z > 0\}$.*
- ▶ *The eigenfunctions $\tilde{\Psi}_{+,1}$ and $\tilde{\Psi}_{-,2}$ are analytic in $\mathbb{C}^- = \{z \in \mathbb{C} \mid \text{Im } z < 0\}$.*
- ▶ *The eigenfunctions $\tilde{\Psi}_{-,1}$, $\tilde{\Psi}_{+,2}$, $\tilde{\Psi}_{+,1}$, and $\tilde{\Psi}_{-,2}$ are continuous up to the real line except at $z = \pm 1$, where $\tilde{\Psi}_{\pm,j}$ ($j = 1, 2$) denote the j -th column of $\tilde{\Psi}_{\pm}$.*

Additionally, for $z \neq \pm 1$ and $z \neq 0$, the symmetries of the coefficient matrices $X_2(z)$ and $T_2(z)$

$$\begin{aligned} X_2(z^*) &= \sigma_1 X_2^*(z) \sigma_1, & X_2(-z) &= \sigma_2 X_2(z) \sigma_2, & X_2(z^{-1}) &= \sigma_1 X_2(z) \sigma_1, \\ T_2(z^*) &= \sigma_1 T_2^*(z) \sigma_1, & T_2(-z) &= \sigma_2 T_2(z) \sigma_2, & T_2(z^{-1}) &= \sigma_1 T_2(z) \sigma_1, \end{aligned}$$

allow us to establish the symmetries of the eigenfunctions $\tilde{\Psi}_{\pm}(z)$

$$\tilde{\Psi}_{\pm}(z^*) = \sigma_1 \tilde{\Psi}_{\pm}^*(z) \sigma_1, \quad \tilde{\Psi}_{\pm}(-z) = \sigma_2 \tilde{\Psi}_{\pm}(z) \sigma_2, \quad \tilde{\Psi}_{\pm}(z^{-1}) = \sigma_1 \tilde{\Psi}_{\pm}(z) \sigma_1, \quad (2.13)$$

for $\pm \text{Im } z \leq 0$ and $z \neq \pm 1$, or equivalently,

$$\tilde{\Psi}_{\pm,1}(z) = \sigma_1 \tilde{\Psi}_{\pm,2}^*(z) = \sigma_3 \sigma_1 \tilde{\Psi}_{\pm,2}(-z) = \sigma_1 \tilde{\Psi}_{\pm,2}(z^{-1}).$$

Furthermore, the combination coefficient matrix $U_2(z)$ is traceless matrix and the relation of equation (2.12) produces the following relation.

Proposition 2.2. *Asymptotic properties and asymptotic behavior of eigenfunctions $\tilde{\Psi}_{\pm}$ at singular points $z = \pm 1$:*

- ▶ *As $z \rightarrow \infty$ (is equivalent to $z \rightarrow 0$ by the symmetry (2.13)), the eigenfunctions $(\tilde{\Psi}_{-}^{(1)} \tilde{\Psi}_{+}^{(2)}) \rightarrow I$ for $\text{Im } z \geq 0$.*
- ▶ *As $z \rightarrow \infty$ (is equivalent to $z \rightarrow 0$ by the symmetry (2.13)), the eigenfunctions $(\tilde{\Psi}_{+}^{(1)} \tilde{\Psi}_{-}^{(2)}) \rightarrow I$ for $\text{Im } z \leq 0$.*
- ▶ *As $z \rightarrow 1$, $\tilde{\Psi}_{\pm}(x, t, z) = \frac{i}{2(z-1)} \alpha_{\pm}(x, t) \begin{pmatrix} -1 & 1 \\ -1 & 1 \end{pmatrix} + O(1)$ with $\alpha_{\pm}(x, t) \in \mathbb{R}$ (understood column-wise, in the corresponding half-planes).*
- ▶ *As $z \rightarrow -1$, $\tilde{\Psi}_{\pm}(x, t, z) = -\frac{i}{2(z+1)} \alpha_{\pm}(x, t) \begin{pmatrix} 1 & 1 \\ -1 & -1 \end{pmatrix} + O(1)$ with the same $\alpha_{\pm}(x, t)$ as the previous ones (by symmetry (2.13)).*

2.3. Scattering matrix. As usual, there is a matrix $S(z) = \{(s_{ij})\}_{i,j=1}^2$ that only depends on the spectral parameter z and associates the eigenfunctions $\tilde{\Psi}_{+}$ and $\tilde{\Psi}_{-}$ on the real line \mathbb{R}

$$\tilde{\Psi}_{+}(x, t, z) = \tilde{\Psi}_{-}(x, t, z) S(z), \quad z \in \mathbb{R}, \quad z \neq \pm 1, \quad (2.14)$$

which is also called scattering matrix. Simple calculations show that

$$s_{22}(z) = \det[\tilde{\Psi}_{-,1}, \tilde{\Psi}_{+,2}], \quad s_{12}(z) = e^{2p} \det[\tilde{\Psi}_{+,2}, \tilde{\Psi}_{-,2}]. \quad (2.15)$$

It follows from the symmetries of eigenfunctions (2.13) that

$$S(z) = \begin{pmatrix} s_{11}(z) & s_{12}(z) \\ s_{21}(z) & s_{22}(z) \end{pmatrix} \triangleq \begin{pmatrix} \overline{a(z)} & b(z) \\ \overline{b(z)} & a(z) \end{pmatrix}. \quad (2.16)$$

The properties of entires of the scattering matrix $S(z)$ in (2.16) are derived by Propositions 2.1, 2.2 and the expressions (2.15) as follow:

Proposition 2.3. *The scattering matrix $S(z)$ is of the following properties:*

- ▶ $a(z)$ is analytic in \mathbb{C}^+ , $a(0) = 1$ and $a(z) \rightarrow 1$ as $z \rightarrow \infty$.
- ▶ $a(z) = \overline{a(-\bar{z})} = a(-z^{-1})$ for $\text{Im } z > 0$.
- ▶ $b(z)$ is continuous for $z \in \mathbb{R} \setminus \{\pm 1\}$, $b(0) = 0$, and $b(z) \rightarrow 0$ as $z \rightarrow \infty$.
- ▶ As $z \rightarrow 1$, there exists a constant $\gamma \in \mathbb{R}$ such that

$$a(z) = \frac{i\gamma}{2(z-1)} + O(1), \quad b(z) = \frac{i\gamma}{2(z-1)} + O(1). \quad (2.17)$$

- ▶ As $z \rightarrow -1$, there exists a constant $\gamma \in \mathbb{R}$ with the same as previous one such that

$$a(z) = \frac{i\gamma}{2(z+1)} + O(1), \quad b(z) = -\frac{i\gamma}{2(z+1)} + O(1). \quad (2.18)$$

- ▶ For $z \in \mathbb{R} \setminus \{\pm 1\}$, $|a(z)|^2 - |b(z)|^2 = 1$.
- ▶ The reflection coefficient $r(z) = \frac{b(z)}{a(z)}$ such that

$$r(z) = -\overline{r(-\bar{z})} \text{ (or } -\overline{r(-z)}) = r(-z^{-1}), \quad z \in \mathbb{R}. \quad (2.19)$$

We cannot rule out that the scattering coefficient $s_{22}(z)$ has zeros on the real axis \mathbb{R} , which are called spectral singularities. In this case, it will bring great difficulties to our work. Therefore, in order to avoid this situation, we make the following assumptions.

Assumption 2.4. *For the scattering coefficient $s_{22}(z)$ generated by the initial data $q_0(x) \in H^{2,1}(\mathbb{R})$ such that*

- (1) *The scattering coefficient $s_{22}(z)$ has no zeros on the real axis \mathbb{R} .*
- (2) *The scattering coefficient $s_{22}(z)$ has finite simple zeros.*

2.4. Construction of Riemann-Hilbert problem. Applying the analytical properties of the eigenfunctions $\tilde{\Psi}_{\pm}$ and the scattering matrix $S(z)$, a piecewise analytical function $\tilde{M}(z) := \tilde{M}(x, t, z)$ can be introduced as usual (it depends on time and space at the same time. In fact, it should be consistent with classical inverse scattering transformation. A piecewise analytical function only related to space is introduced, and the time part is processed through time evolution. The two processing methods are essentially equivalent here).

$$\tilde{M}(z) := \tilde{M}(x, t, z) = \begin{cases} \left(\frac{\tilde{\Psi}_{-,1}(x, t, z)}{a(z)} \tilde{\Psi}_{+,2}(x, t, z) \right), & z \in \mathbb{C}^+, \\ \left(\tilde{\Psi}_{+,1}(x, t, z) \frac{\tilde{\Psi}_{-,2}(x, t, z)}{a(z)} \right), & z \in \mathbb{C}^-. \end{cases} \quad (2.20)$$

Then the piecewise analytical function $\tilde{M}(z)$ solves the following RH problem.

RH Problem 2.5. *Find a 2×2 matrix-valued function $\tilde{M}(z)$ satisfying*

- (I) *Analytic condition: $\tilde{M}(z)$ is meromorphic in $\mathbb{C} \setminus \mathbb{R}$.*
- (II) *Symmetry condition: $\tilde{M}(z) = \overline{\tilde{M}(\bar{z}^{-1})} = \sigma_1 \overline{\tilde{M}(\bar{z})} \sigma_1 = \sigma_3 \overline{\tilde{M}(-\bar{z})} \sigma_3$.*

(III) *Jump condition:*

$$\widetilde{M}_+(z) = \widetilde{M}_-(z)\widetilde{V}(z), \quad z \in \mathbb{R} \setminus \{\pm 1\}, \quad (2.21)$$

where the matrix $\widetilde{V}(z)$ is defined by

$$\widetilde{V}(z) = \begin{pmatrix} 1 - r(z)\bar{r}(z) & r(z)e^{-2p(z)} \\ -\bar{r}(z)e^{2p(z)} & 1 \end{pmatrix}, \quad (2.22)$$

with $p(z) := p(x, t, z)$ in (2.10).

(IV) *Asymptotic conditions:* $\widetilde{M}(z) \rightarrow I$ as $z \rightarrow \infty$ ($z \rightarrow 0$).

(V) *Singularity conditions:*

$$\widetilde{M}(z) = \begin{cases} \frac{i\alpha_+}{2(z-1)} \begin{pmatrix} -c & 1 \\ -c & 1 \end{pmatrix} + O(1), & z \rightarrow 1, \operatorname{Im} z > 0, \\ -\frac{i\alpha_+}{2(z+1)} \begin{pmatrix} c & 1 \\ -c & -1 \end{pmatrix} + O(1), & z \rightarrow -1, \operatorname{Im} z > 0, \end{cases} \quad (2.23)$$

where $\alpha_+ \in \mathbb{R}$ and

$$c = \begin{cases} 0, & \gamma \neq 0, \\ \frac{a(1) + b(1)}{a(1)}, & \gamma = 0. \end{cases}$$

(VI) *Residue conditions:* $\widetilde{M}(z)$ has simple poles in $\mathcal{Z} = \{\eta_n, \bar{\eta}_n\}_{n=1}^{8N_1+4N_2}$ with

$$\operatorname{Res}_{\eta_n} \widetilde{M}(z) = \lim_{z \rightarrow \eta_n} \widetilde{M}(z) \begin{pmatrix} 0 & 0 \\ c_n e^{2p(\eta_n)} & 0 \end{pmatrix}, \quad (2.24)$$

$$\operatorname{Res}_{\bar{\eta}_n} \widetilde{M}(z) = \lim_{z \rightarrow \bar{\eta}_n} \widetilde{M}(z) \begin{pmatrix} 0 & \bar{c}_n e^{-2p(\bar{\eta}_n)} \\ 0 & 0 \end{pmatrix}, \quad (2.25)$$

where the discrete spectrums $\eta_n = z_n$, $\eta_{n+N_1} = -\bar{z}_n$, $\eta_{n+2N_1} = -z_n^{-1}$, and $\eta_{n+3N_1} = \bar{z}_n^{-1}$ for $n = 1, 2, \dots, N_1$, the discrete spectrums on the unit circle are expressed as $\eta_{m+4N_1} = \kappa_m$ and $\eta_{m+4N_1+N_2} = -\bar{\kappa}_m$ for $m = 1, 2, \dots, N_2$.

Proof. See [5]. □

In order to recover the potential function, we need to further consider the behavior at singular point $z = i$ corresponding to $\lambda = 0$, which has been reported in [5]. Here we will briefly review it. The Lax pair (2.5) under the new spectrum parameter z becomes

$$\Psi_x + \frac{i(z^2 - 1)}{4z} \sigma_3 \Psi = X_3 \Psi, \quad (2.26a)$$

$$\Psi_t - \frac{2i(z^2 - 1)z}{(z^2 + 1)^2} \sigma_3 \Psi = T_3 \Psi, \quad (2.26b)$$

where

$$X_3 = \frac{(z^2 + 1)(\check{m} - 1)}{2(z^2 - 1)}\sigma_2 - \left(\frac{iz(\check{m} - 1)}{z^2 - 1} + \frac{i(z^2 - 1)\check{m}}{4z} - \frac{i(z^2 - 1)}{4z} \right)\sigma_3,$$

$$T_3 = \frac{i(z^2 - 1)}{4z}(q^2 - q_x^2 + 2q)\check{m}\sigma_3 + T_2(x, t, z).$$

Introducing the variable

$$p_0(x, t, z) = \frac{i(z^2 - 1)}{4z}x - \frac{2i(z^2 - 1)}{(z^2 + 1)^2}t, \quad (2.27)$$

and $P_0 = p_0\sigma_3$, $\tilde{\Psi}_0 = \Psi e^{P_0}$ transforms the Lax pair (2.26) into

$$\tilde{\Psi}_{0,x} + [P_{0,x}, \tilde{\Psi}_0] = X_3\tilde{\Psi}_0, \quad (2.28a)$$

$$\tilde{\Psi}_{0,t} + [P_{0,t}, \tilde{\Psi}_0] = T_3\tilde{\Psi}_0, \quad (2.28b)$$

from which one obtains the solution to Lax pair (2.28)

$$\tilde{\Psi}_{0,\pm}(x, t, z) = I + \int_{\pm\infty}^x e^{-\frac{i(z^2-1)}{4z}(x-\xi)\sigma_3} X_3(\xi, t, z) \tilde{\Psi}_{0,\pm}(\xi, t, z) e^{\frac{i(z^2-1)}{4z}(x-\xi)\sigma_3} d\xi, \quad (2.29)$$

which is also called Jost functions. Similar to CH and SP equations, the Jost functions $\tilde{\Psi}_{0,\pm}$ and $\tilde{\Psi}$ are related by matrices $C_{\pm}(z)$ independent of x and t :

$$\tilde{\Psi}_{\pm}(x, t, z) = \tilde{\Psi}_{0\pm}(x, t, z) e^{-p_0(x,t,z)\sigma_3} C_{\pm}(z) e^{p(x,t,z)\sigma_3}, \quad (2.30)$$

a calculation reveals that $C_{\pm}(z) = e^{(p_0(\pm\infty,t,z) - p(\pm\infty,t,z))\sigma_3}$ and $p(x, t, z) - p_0(x, t, z) = -\frac{i(z^2-1)}{4z} \int_x^{-\infty} (\check{m}(\xi, t) - 1) d\xi$, thus

$$C_+(z) \equiv I, \quad C_-(z) = e^{\frac{i(z^2-1)}{4z} \int_{-\infty}^{\infty} (\check{m}(\xi, t) - 1) d\xi \sigma_3}.$$

Additionally, observing that $\tilde{\Psi}_{0,\pm}(x, t, i) \equiv I$ from the fact $X_3(x, t, i) \equiv 0$, then we have

$$\tilde{\Psi}_+(x, t, i) = e^{\frac{1}{2} \int_x^{+\infty} (\check{m}(\xi, t) - 1) d\xi \sigma_3}, \quad \tilde{\Psi}_-(x, t, i) = e^{-\frac{1}{2} \int_{-\infty}^x (\check{m}(\xi, t) - 1) d\xi \sigma_3}, \quad (2.31)$$

which leads to

$$a(i) = e^{-\frac{1}{2} \int_{-\infty}^{+\infty} (\check{m}(\xi, t) - 1) d\xi} \quad (2.32)$$

and

$$M(x, t, i) = \begin{pmatrix} e^{\frac{1}{2} \int_x^{+\infty} (\check{m}(\xi, t) - 1) d\xi} & 0 \\ 0 & e^{-\frac{1}{2} \int_x^{+\infty} (\check{m}(\xi, t) - 1) d\xi} \end{pmatrix}, \quad (2.33)$$

from expressions (2.15) and (2.20).

By analogy with CH equation [7, 8], we transform the (x, t) -plane into (y, t) -plane by

$$y(x, t) = x - \int_x^{-\infty} (\check{m}(\xi, t) - 1) d\xi, \quad (2.34)$$

and introduce a new matrix-valued function $M(z) := M(y(x, t), t, z)$ satisfying

$$\widetilde{M}(x, t, z) = M(y(x, t), t, z) \quad (2.35)$$

which solves the following RH problem.

RH Problem 2.6. *Find a matrix $M(y, t, z)$ such that the following conditions:*

(a) $M(z)$ is analytic in $\mathbb{C} \setminus \{\mathbb{R} \cup \mathcal{Z}\}$.

(b) $M(z) = \overline{M(\bar{z}^{-1})} = \sigma_1 \overline{M(\bar{z})} \sigma_1 = \sigma_3 \overline{M(-\bar{z})} \sigma_3$.

(c) *Jump condition: The non-tangential limits $M_{\pm}(z) = \lim_{\varepsilon \rightarrow 0^+} M(z \pm i\varepsilon)$ for $z \in \mathbb{R} \setminus \{\pm 1\}$*

$$M_+(z) = M_-(z)V(z), \quad z \in \mathbb{R} \setminus \{\pm 1\}, \quad (2.36)$$

where the jump matrix $V(z)$ is defined by

$$V(z) = \begin{pmatrix} 1 - |r(z)|^2 & r(z)e^{-2it\theta(z)} \\ -\bar{r}(z)e^{2it\theta(z)} & 1 \end{pmatrix} \quad (2.37)$$

with the phase function $\theta(z) = -\frac{i(z^2-1)}{4z} \left(-y + \frac{8t}{(z^2+1)^2} \right)$.

(d) *Asymptotic behavior:*

$$M(z) = I + O(z^{-1}), \quad z \rightarrow \infty \quad (\text{and } z \rightarrow 0 \text{ by symmetry}), \quad (2.38)$$

$$M(z) = \begin{pmatrix} a_1(y, t) & 0 \\ 0 & a_1^{-1}(y, t) \end{pmatrix} + \begin{pmatrix} 0 & a_2(y, t) \\ a_3(y, t) & 0 \end{pmatrix} (z - i) + O((z - i)^2), \quad (2.39)$$

where $a_j(y, t)$, $j = 1, 2, 3$ are real-valued functions from the expansion of $M(z)$ at $z = i$.

(e) *The singularity:*

$$M(z) = \frac{i\tilde{\alpha}_+}{2(z-1)} \begin{pmatrix} -c & 1 \\ -c & 1 \end{pmatrix} + O(1), \quad z \rightarrow 1, \quad \text{Im } z > 0, \quad (2.40)$$

$$M(z) = -\frac{i\tilde{\alpha}_+}{2(z+1)} \begin{pmatrix} -c & 1 \\ c & -1 \end{pmatrix} + O(1), \quad z \rightarrow -1, \quad \text{Im } z < 0. \quad (2.41)$$

(f) *Residue conditions: The matrix $M(z)$ has simple poles at η_n and $\bar{\eta}_n$ with*

$$\text{Res}_{\eta_n} M(z) = \lim_{z \rightarrow \eta_n} M(z) \begin{pmatrix} 0 & 0 \\ c_n e^{2it\theta(\eta_n)} & 0 \end{pmatrix}, \quad (2.42a)$$

$$\text{Res}_{\bar{\eta}_n} M(z) = \lim_{z \rightarrow \bar{\eta}_n} M(z) \begin{pmatrix} 0 & \bar{c}_n e^{-2it\bar{\theta}(\bar{\eta}_n)} \\ 0 & 0 \end{pmatrix}. \quad (2.42b)$$

(g) *The solution to the mCH equation (1.4) is expressed by*

$$\begin{aligned} q(x, t) &= q(y(x, t), t) = -\partial_z M_{12}(z)|_{z=i} M_{11}(i) - \partial_z M_{21}(z)|_{z=i} M_{11}(i)^{-1}, \\ x(y, t) &= y + \ln M_{11}(i). \end{aligned} \quad (2.43)$$

It follows from the results [22, 69, 70] that the following map is Lipschitz:

$$\mathcal{D} : H^{2,1}(\mathbb{R}) \ni q_0(x) \mapsto r(z) \in H^{1,1}(\mathbb{R}), \quad (2.44)$$

where some spaces are defined as follows:

(I) The Sobolev space:

$$W^{j,k}(\mathbb{R}) = \left\{ f(x) \in L^k(\mathbb{R}) : \partial_x^m f(x) \in L^k(\mathbb{R}), m = 1, \dots, j \right\}. \quad (2.45)$$

(II) The weighted Sobolev space

$$H^{j,k}(\mathbb{R}) = \left\{ f(x) \in L^2(\mathbb{R}) : \partial_x^j f(x) \in L^2(\mathbb{R}), |x|^k f(x) \in L^2(\mathbb{R}) \right\}. \quad (2.46)$$

(III) The weighted $L^p(\mathbb{R})$ space

$$L^{p,s}(\mathbb{R}) = \{ f(x) \in L^p(\mathbb{R}) : |x|^s f(x) \in L^p(\mathbb{R}) \}, \quad (2.47)$$

(IV) Define $A \lesssim B$ for any quantities A and B , if there exists a constant $c > 0$ such that $|A| \leq c|B|$. Additionally, the norm of $f(x) \in L^p(\mathbb{R})$ ($L^{p,s}(\mathbb{R})$) are abbreviated to $\|f\|_p$ ($\|f\|_{p,s}$), respectively.

3. DISTRIBUTION OF PHASE POINTS AND SYMBOL TABLE

The jump matrix $V(z)$ in (2.37) is of the triangular decomposition

$$V(z) = \begin{cases} \begin{pmatrix} 1 & r(z)e^{-2it\theta(z)} \\ 0 & 1 \end{pmatrix} \begin{pmatrix} 1 & 0 \\ -\bar{r}(z)e^{-2it\theta(z)} & 1 \end{pmatrix}, & z \in \Sigma_a(\xi), \\ \begin{pmatrix} 1 & 0 \\ -\frac{\bar{r}(z)}{1-|r(z)|^2}e^{2it\theta(z)} & 1 \end{pmatrix} (1-|r(z)|^2)^{\sigma_3} \begin{pmatrix} 1 & \frac{r(z)}{1-|r(z)|^2}e^{-2it\theta(z)} \\ 0 & 1 \end{pmatrix}, & z \in \Sigma_b(\xi). \end{cases} \quad (3.1)$$

Following the basic idea of the nonlinear steepest descent method [27, 29], the triangular decomposition (3.1) of the jump matrix is used so that the (oscillation) jump matrix of the modified RH problem on steepest descent line can be exponentially attenuated to the identity matrix in appropriate regions as $t \rightarrow +\infty$. Whereas, the analysis of the oscillation RH problem is mainly based on the growth and decay properties of the exponential functions $e^{\pm 2it\theta(z)}$ appearing in the jump matrix $V(z)$ (2.37) and residue conditions (2.42), and whether there is a phase point also affects the leading term of the solution. As indicated in [11], the structure of $\Sigma_a(\xi)$ and $\Sigma_b(\xi)$ is affected by the ranges of values of ξ . That is, the four value ranges of ξ can be distinguished, $\Sigma_a(\xi)$ and $\Sigma_b(\xi)$ have different structures, which means four different types of large time asymptotics: (i) $\xi > 2$, (ii) $0 < \xi < 2$, (iii) $-\frac{1}{4} < \xi < 0$, (iv) $\xi < -\frac{1}{4}$.

Thus, we now analyze the exponential function in the jump matrix. Observing that the phase function $\theta(z)$ defined by (2.37)

$$\theta(z) = -\frac{i(z^2 - 1)}{4z} \left(-y + \frac{8t}{(z^2 + 1)^2} \right). \quad (3.2)$$

Let $\xi = \frac{y}{t}$, then the imaginary part of the phase function can be shown in Fig.2. The stationary points of phase function $\theta(z)$ are determined by $\frac{d\theta(z)}{dz} = 0$, where

$$\frac{d\theta(z)}{dz} = \frac{\xi z^8 + 4\xi z^6 + 8z^6 + 6\xi z^4 - 48z^4 + 4\xi z^2 + 8z^2 + \xi}{z^2(z^2 + 1)^3}. \quad (3.3)$$

Proposition 3.1. *The distribution of stationary points for the phase function θ is based on the value range of $\xi = \frac{y}{t}$:*

- (i) As $\xi > 2$ and $\xi < -1/4$, there is no stationary points on the real axis \mathbb{R} .
- (ii) As $0 < \xi < 2$, there are four stationary points on the real axis \mathbb{R} , which are respectively recorded as ξ_1, ξ_2, ξ_3 , and ξ_4 , and satisfy $\xi_4 < \xi_3 < \xi_2 < \xi_1$ as well as $\xi_1 > 1, \xi_4\xi_3 = 1, \xi_2\xi_1 = 1$ and $\xi_1\xi_3 = -1$ shown in Fig. 2.
- (iii) As $-1/4 < \xi < 0$, there are eight stationary points on the real axis \mathbb{R} , which are respectively recorded as $\xi_1, \xi_2, \xi_3, \dots, \xi_8$ satisfying

$$\xi_8 < \dots < \xi_2 < \xi_1 (> 1), \quad \xi_1\xi_4 = \xi_5\xi_8 = -\xi_2\xi_6 = -\xi_3\xi_7 = 1, \quad \xi_j = -\xi_{9-j}, \quad j = 1, 2, 3, 4.$$

This results lead to the structure of $\Sigma_b(\xi)$ expressed as

$$\Sigma_b(\xi) = \begin{cases} \emptyset, & \xi > 2, \\ (\xi_4, \xi_3) \cup (\xi_2, \xi_1), & 0 < \xi < 2, \\ (-\infty, \xi_8) \cup (\xi_7, \xi_6) \cup (\xi_5, \xi_4) \cup (\xi_3, \xi_2) \cup (\xi_1, +\infty), & -\frac{1}{4} < \xi < 0, \\ (-\infty, +\infty), & \xi < -\frac{1}{4}, \end{cases} \quad (3.4)$$

and $\Sigma_a(\xi) = \mathbb{R} \setminus \Sigma_b(\xi)$.

Proof. It follows from $\frac{d\theta(z)}{dz} = 0$ (3.3) that

$$\xi z^8 + 4\xi z^6 + 8z^6 + 6\xi z^4 - 48z^4 + 4\xi z^2 + 8z^2 + \xi = 0, \quad (3.5)$$

from which one obtains

$$\xi = \frac{2 - 8z^2}{(1 + 4z^2)^2}. \quad (3.6)$$

As in [8, 9, 11], the distribution of corresponding steady-state phase points in four cases can be calculated, respectively. \square

Remark 3.2. As $\xi \in (-\infty, -1/4) \cup (2, +\infty)$, there is no steady-state phase point. Whereas, as $\xi \in (-1/4, 0) \cup (0, 2)$, there exists eight and four phase points, respectively. Each phase points have different properties. Specifically, as $\xi \in (0, 2)$, $\theta''(\xi_j) > 0$ for $j = 1, 3$ and $\theta''(\xi_j) < 0$ for $j = 2, 4$. As $\xi \in (-1/4, 0)$, $\theta''(\xi_j) > 0$ for $j = 2, 4, 6, 8$ and $\theta''(\xi_j) < 0$ for $j = 1, 3, 5, 7$, which shown in Fig.1. For convenience, we introduce the following notation

$$\eta_j = \text{sgn}(\theta''(\xi_j)) = \begin{cases} 1, & j = 1, 3 \text{ as } \xi \in (0, 2) \text{ and } j = 2, 4, 6, 8 \text{ as } \xi \in (-1/4, 0), \\ -1, & j = 2, 4 \text{ as } \xi \in (0, 2) \text{ and } j = 1, 3, 5, 7 \text{ as } \xi \in (-1/4, 0), \end{cases} \quad (3.7)$$

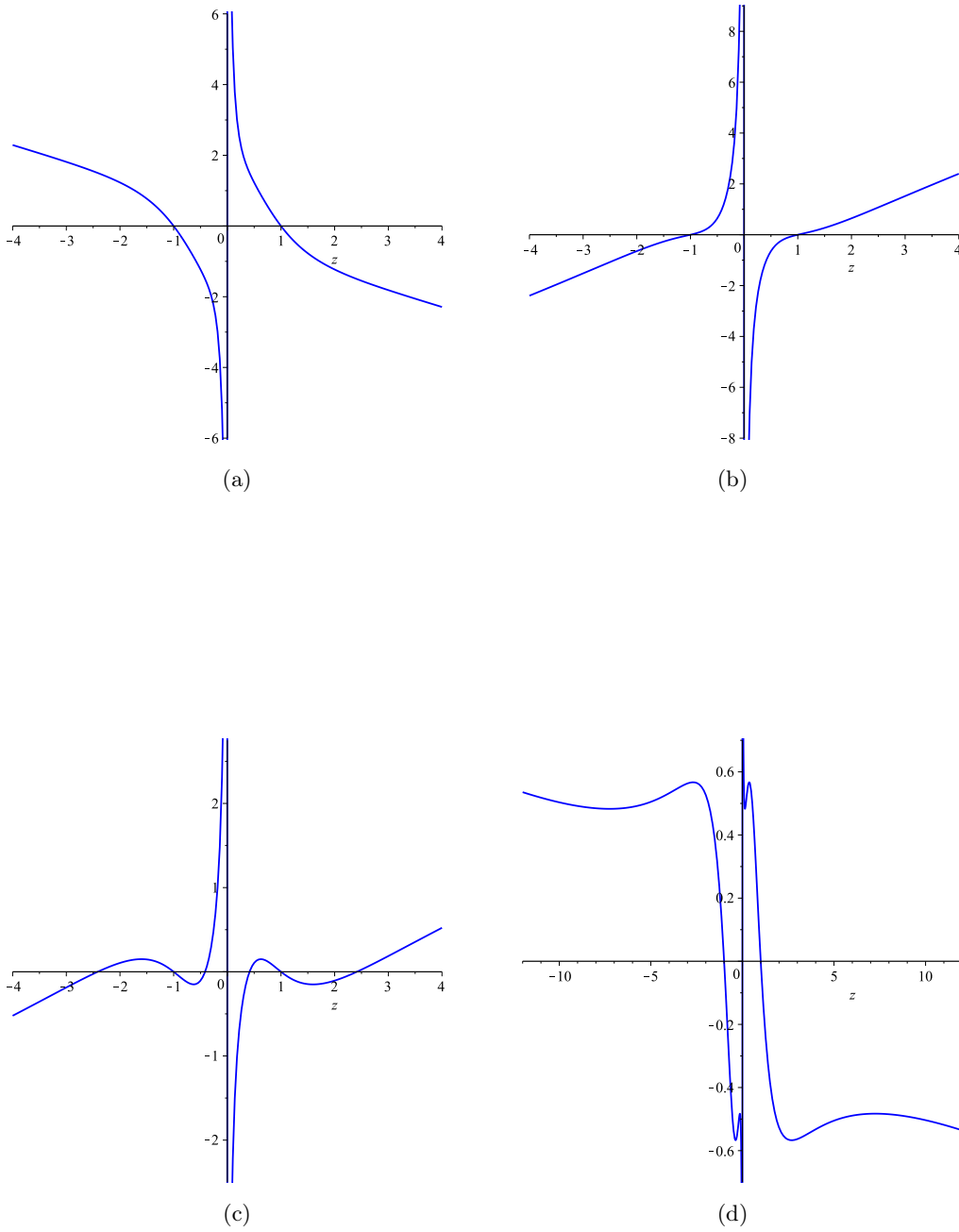

FIGURE 1. Variation diagram of phase function θ with ξ value range. (a) and (b) correspond to $\xi \in (-\infty, -1/4) \cup (2, +\infty)$. (c) corresponds to $\xi = 1 \in (0, 2)$. (d) corresponds to $\xi = -1/8 \in (-1/4, 0)$.

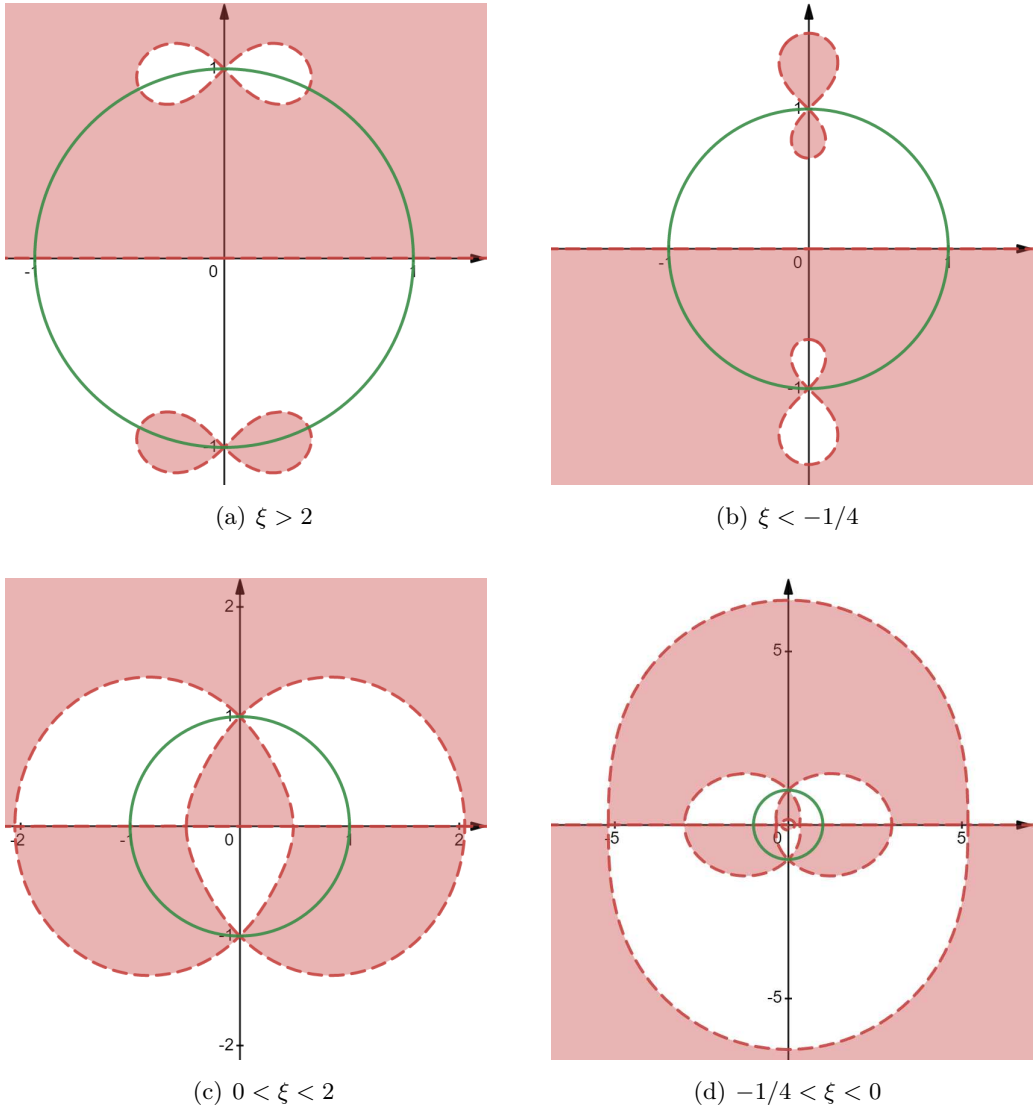

FIGURE 2. Plots of the imaginary part $\text{Im}\theta$ of phase function θ : (a) $\xi > 2$. (b) $\xi < -1/4$. (c) $0 < \xi < 2$. (d) $-1/4 < \xi < 0$, where $\text{Im}\theta > 0$ in red region and $\text{Im}\theta < 0$ in white region.

► For $\xi > 2$ and $\xi < -\frac{1}{4}$, we will study the long-time asymptotic behavior of mCH equation (1.7), and prove that its solution can be characterized by N -soliton solution and error term shown in Section 4.

► For $0 < \xi < 2$ and $-\frac{1}{4} < \xi < 0$, which correspond to four and eight phase points respectively, we prove that the soliton resolution conjecture is valid for mCH equation (1.5) with non-zero boundary, that is, when the time tends to infinity, the solution can be characterized by the soliton solution corresponding to the discrete spectrum, the leading term corresponding to the continuous spectrum and error term corresponding to pure $\bar{\partial}$ -problem.

In order to facilitate the later analysis, the sign of the number of steady-state phase points is introduced by

$$n(\xi) = \begin{cases} 0, & \xi > 2, \xi < -\frac{1}{4}, \\ 4, & 0 < \xi < 2, \\ 8, & -\frac{1}{4} < \xi < 0, \end{cases} \quad (3.8)$$

and define $N = \{1, 2, \dots, 4N_1 + 2N_2\}$, and fix a sufficiently small positive number ε_0 to satisfy

$$\Delta = \{n \in N \mid \text{Im } \theta < 0\}, \quad \nabla = \{n \in N \mid \text{Im } \theta > 0\}, \quad \Lambda = \{n \in N \mid |\text{Im } \theta| \leq \varepsilon_0\}.$$

Observing that the oscillatory term $e^{2it\theta}$ appearing in residue condition (2.42a) grows as $t \rightarrow +\infty$ for η_n with $n \in \Delta$, also for η_n with $n \in \nabla$ the residue condition (2.42a) decays as $t \rightarrow +\infty$.

4. DEFORMATION OF RH PROBLEM FOR $\xi > 2$ AND $\xi < -1/4$

In this section, we turn our attention to $\xi > 2$ and $\xi < -1/4$ corresponding to Figures 2(a) and 2(b), which corresponds to the case where there is no steady-state phase point. In order to perform a long-time asymptotic analysis through the nonlinear steepest descent method, we need to deal with the original RH problem with the following conditions:

- (i) Interpolating poles are transformed to jump conditions on each pole circle by trading their residues for η_n with $n \in \Lambda$.
- (ii) The jump of the original RH problem 2.6 on the real axis \mathbb{R} is traded to the exponentially decaying contour.

In order to eliminate the diagonal matrix in (3.1) in the triangular decomposition on interval $\Sigma_b(\xi)$, as [11], the scalar RH problem satisfied by $\delta(z) := \delta(z, \xi)$, which is analytic in $\mathbb{C} \setminus \overline{\Sigma_b(\xi)}$ needs to be introduced

$$\delta_+(z) = \delta_-(z)(1 - |r(z)|^2), \quad z \in \Sigma_b(\xi), \quad (4.1a)$$

$$\delta(z) \rightarrow I, \quad z \rightarrow \infty. \quad (4.1b)$$

The solution to (4.1) can be derived by Pelemlj formula

$$\delta(z) = \exp \left\{ \frac{1}{2\pi i} \int_{\Sigma_b(\xi)} \frac{\ln(1 - |r(s)|^2)}{s - z} ds \right\}. \quad (4.2)$$

Define some functions as

$$\nu(z) = -\frac{1}{2\pi} \ln(1 - |r(z)|^2), \quad \delta(z) = \exp \left\{ -i \int_{\Sigma_b(\xi)} \frac{\nu(s)}{s-z} ds \right\}, \quad (4.3)$$

$$\begin{aligned} T(z) &:= T(z, \xi) = \prod_{n \in \Delta} \frac{z - \eta_n}{\bar{\eta}_n^{-1} z - 1} \delta(z) \\ &= \prod_{j \in \Delta_1} \frac{z - z_j}{\bar{z}_j^{-1} z - 1} \frac{z + \bar{z}_j}{z_j^{-1} z + 1} \frac{z - \bar{z}_j^{-1}}{z_j z - 1} \frac{z + z_j^{-1}}{\bar{z}_j z + 1} \prod_{i \in \Delta_2} \frac{z - w_i}{w_i z - 1} \frac{z + \bar{w}_i}{\bar{w}_i z + 1} \delta(z, \xi), \end{aligned} \quad (4.4)$$

where the intervals Δ_j , ∇_j and Λ_j for $j = 1, 2$ are defined as

$$\nabla_1 = \{j \in \{1, \dots, N_1\} \mid \operatorname{Im} \theta(z_j) > 0\}, \quad \Delta_1 = \{j \in \{1, \dots, N_1\} \mid \operatorname{Im} \theta(z_j) < 0\}, \quad (4.5a)$$

$$\nabla_2 = \{i \in \{1, \dots, N_2\} \mid \operatorname{Im} \theta(w_i) > 0\}, \quad \Delta_2 = \{i \in \{1, \dots, N_2\} \mid \operatorname{Im} \theta(w_i) < 0\}, \quad (4.5b)$$

$$\Lambda_1 = \{j_0 \in \{1, \dots, N_1\} \mid |\operatorname{Im} \theta(z_{j_0})| \leq \delta_0\}, \quad \Lambda_2 = \{i_0 \in \{1, \dots, N_2\} \mid |\operatorname{Im} \theta(w_{i_0})| \leq \delta_0\}. \quad (4.5c)$$

Proposition 4.1. *The function $T(z)$ defined by (4.1) such that the following conditions*

(i) *The function $T(z)$ is meromorphic in $\mathbb{C} \setminus \mathbb{R}$, and for $n \in \Delta$, $T(z)$ has a simple zeros at η_n and simple poles at $\bar{\eta}_n$.*

(ii) *$T(z) = \overline{T(-\bar{z})} = T(-z^{-1}) = \overline{T^{-1}(\bar{z})}$.*

(iii) *For $z \in \Sigma_b(\xi)$, the non-tangential boundary values $T_{\pm}(z) := T_{\pm}(z, \xi)$, which satisfy:*

$$T_+(z) = (1 - |r(z)|^2) T_-(z), \quad z \in \Sigma_b(\xi). \quad (4.6)$$

(iv) *$\lim_{z \rightarrow \infty} T(z) \triangleq T(\infty)$ with $T(\infty) = 1$.*

(v) *As $z = i$,*

$$T(i) = \prod_{j \in \Delta_1} \left(\frac{i - z_j}{i - \bar{z}_j} \frac{i + \bar{z}_j}{i + z_j} \right) \prod_{h \in \Delta_2} \frac{i - w_h}{i + w_h} \frac{i + \bar{w}_h}{i - \bar{w}_h} \delta(i, \xi), \quad (4.7)$$

and as $z \rightarrow i$, $T(z)$ has asymptotic expansion as

$$T(z) = T(i) (1 - T_0(\xi)(z - i)) + \mathcal{O}((z - i)^2), \quad (4.8)$$

with

$$T_0(\xi) = \frac{1}{2\pi i} \int_{\Sigma_b(\xi)} \frac{\ln(1 - |r(s)|^2)}{(s - i)^2} ds; \quad (4.9)$$

(vi) *$T(z)$ is continuous at $z = 0$, and*

$$T(0) = T(\infty) = 1. \quad (4.10)$$

(vii) *As $z \rightarrow \xi_j$ along any ray $\xi_j + e^{i\phi} \mathbb{R}^+$ with $|\phi| < \pi$,*

$$|T(z, \xi) - T_j(\xi)(z - \xi_j)^{i\nu(\xi_j)}| \lesssim \|r\|_{H^1(\mathbb{R})} |z - \xi_j|^{1/2}, \quad (4.11)$$

where $T_j(\xi)$ are determined by

$$T_j(\xi) = \prod_{n \in \Delta} \frac{z - \eta_n}{\bar{\eta}_n^{-1} z - 1} e^{i\beta(\xi_j, \xi)}, \quad (4.12)$$

for $j = 1, \dots, n(\xi)$ and

$$\beta_j(z, \xi) = \int_{\Sigma_b(\xi)} \frac{\nu(s)}{s-z} ds - \ln(z - \xi_j) \nu(\xi_j). \quad (4.13)$$

Proof. Simple calculations show that the claims (i)-(vi) are hold. Next, we will prove the claim (vii). Observing that the solution to (4.1) can be written as

$$\delta(z) = \exp(i\beta_j(z, \xi) + \nu(\xi_j) \ln(z - \xi_j)). \quad (4.14)$$

It also follows from [3] that

$$\left| (z - \xi_j)^{i\nu(\xi_j)} \right| \leq e^{-\pi\nu(\xi_j)}.$$

Combining the function $T(z)$ with (4.14) yields that

$$T(z) = \prod_{n \in \Delta} \frac{z - \eta_n}{\bar{\eta}_n^{-1} z - 1} (z - \xi_j)^{i\nu(\xi_j)} \exp(i\beta_j(z, \xi_j)). \quad (4.15)$$

Then one has

$$|\beta_j(z, \xi) - \beta_j(z, \xi_j)| \leq |\nu(\xi_j) \ln(z - \xi_j)| + \left| \int_{\Sigma_b(\xi)} \frac{\nu(s)}{s-z} ds - \int_{\Sigma_b(\xi)} \frac{\nu(s)}{s-\xi_j} ds \right|. \quad (4.16)$$

For the first term of (4.16),

$$\nu(\xi_j) \ln(z - \xi_j) = \nu(\xi_j)(z - \xi_j) + O((z - \xi_j)^2). \quad (4.17)$$

For the second term of (4.16), applying Hölder inequality obtains

$$\begin{aligned} \left| \int_{\Sigma_b(\xi)} \frac{\nu(s)}{s-z} ds - \int_{\Sigma_b(\xi)} \frac{\nu(s)}{s-\xi_j} ds \right| &\leq 2\pi |C\nu(z) - C\nu(\xi_j)| = 2\pi \left| \int_{\xi_j}^z C\nu'(s) ds \right| \\ &\leq \|C\nu'\|_{L^2} |z - \xi_j|^{1/2} \lesssim \|r(z)\|_{H^1(\mathbb{R})} |z - \xi_j|^{1/2}, \end{aligned} \quad (4.18)$$

where C denotes the Cauchy operator, which implies that the proof of the proposition is completed. \square

In order to transform the residue conditions at the poles into jump conditions on sufficient small disks, a positive constant ϵ is introduced

$$\varrho = \frac{1}{2} \min \left\{ \min_{j \in N} \{ |\operatorname{Im} \eta_j| \}, \min_{j \in N \setminus \Lambda, \operatorname{Im} \theta(z)=0} |\eta_j - z|, \min_{i \neq j \in N} |\eta_i - \eta_j|, \min_{j \in N} |\eta_j - i| \right\}, \quad (4.19)$$

from which we define the disks $\mathbb{P}_n = \mathbb{P}(\eta_n, \epsilon)$ and $\bar{\mathbb{P}}_n = \mathbb{P}(\bar{\eta}_n, \epsilon)$. Observe that for any $n \in N$, the disks \mathbb{P}_n are pairwise disjoint, and also disjoint with $\{z \in \mathbb{C} \mid \operatorname{Im} \theta(z) = 0\}$ and the real axis \mathbb{R} . The

interpolation matrix $F(z)$ is further introduced as follows

$$F(z) = \begin{cases} \begin{pmatrix} 1 & 0 \\ -C_n(z - \eta_n)^{-1}e^{2it\theta_n} & 1 \end{pmatrix}, & \text{as } z \in \mathbb{P}_n, n \in \nabla \setminus \Lambda, \\ \begin{pmatrix} 1 & -C_n^{-1}(z - \eta_n)e^{-2it\theta_n} \\ 0 & 1 \end{pmatrix}, & \text{as } z \in \mathbb{P}_n, n \in \Delta \setminus \Lambda, \\ \begin{pmatrix} 1 & \overline{C}_n(z - \overline{\eta}_n)^{-1}e^{-2it\overline{\theta}_n} \\ 0 & 1 \end{pmatrix}, & \text{as } z \in \overline{\mathbb{P}}_n, n \in \nabla \setminus \Lambda, \\ \begin{pmatrix} 1 & 0 \\ \overline{C}_n^{-1}(z - \overline{\eta}_n)e^{2it\overline{\theta}_n} & 1 \end{pmatrix}, & \text{as } z \in \overline{\mathbb{P}}_n, n \in \Delta \setminus \Lambda. \\ I & \text{as } z \text{ in elsewhere;} \end{cases} \quad (4.20)$$

Applying interpolation matrix $F(z)$ (4.20) to define a new matrix $M^{(1)}(z) := M^{(1)}(y, t, z)$ such that

$$M^{(1)}(z) = M(z)F(z)T(z)\sigma_3, \quad (4.21)$$

which solves the following problem.

RH Problem 4.2. *Find a matrix-valued function $M^{(1)}(z)$ satisfy the following conditions:*

(I) *The function $M^{(1)}(z)$ is meromorphic in $\mathbb{C} \setminus \Sigma^{(1)}$, where the contour*

$$\Sigma^{(1)} = \mathbb{R} \cup \left(\bigcup_{n \in N \setminus \Lambda} (\mathbb{P}_n \cup \overline{\mathbb{P}}_n) \right).$$

(II) *The symmetries:*

$$M^{(1)}(z) = \overline{M^{(1)}(\bar{z}^{-1})} = \sigma_1 \overline{M^{(1)}(\bar{z})} \sigma_1 = \sigma_3 \overline{M^{(1)}(-\bar{z})} \sigma_3.$$

(III) *Jump condition: The non-tangential limits $M_{\pm}^{(1)}(z) = \lim_{\varepsilon \rightarrow 0^+} M^{(1)}(z + \pm i\varepsilon)$ for $z \in \mathbb{R} \setminus \{\pm 1\}$*

$$M_+^{(1)}(z) = M_-^{(1)}(z)V^{(1)}(z), \quad z \in \mathbb{R} \setminus \Sigma^{(1)}, \quad (4.22)$$

where the jump matrix $V^{(1)}(z)$ is defined by

$$V^{(1)}(z) = \begin{cases} \begin{pmatrix} 1 & r(z)T^2(z)e^{-2it\theta(z)} \\ 0 & 1 \end{pmatrix} \begin{pmatrix} 1 & 0 \\ -\bar{r}(z)T^{-2}(z)e^{-2it\theta(z)} & 1 \end{pmatrix}, & z \in \Sigma_a(\xi), \\ \begin{pmatrix} 1 & 0 \\ -\frac{\bar{r}(z)}{1-|r(z)|^2}T^{-2}(z)e^{2it\theta(z)} & 1 \end{pmatrix} \begin{pmatrix} 1 & \frac{r(z)}{1-|r(z)|^2}T_+^2(z)e^{-2it\theta(z)} \\ 0 & 1 \end{pmatrix}, & z \in \Sigma_b(\xi), \\ \begin{pmatrix} 1 & 0 \\ -C_n(z - \eta_n)^{-1}T^{-2}(z)e^{2it\theta_n} & 1 \end{pmatrix}, & z \in \mathbb{P}_n, n \in \nabla \setminus \Lambda, \\ \begin{pmatrix} 1 & -C_n^{-1}(z - \eta_n)T^2(z)e^{-2it\theta_n} \\ 0 & 1 \end{pmatrix}, & z \in \mathbb{P}_n, n \in \Delta \setminus \Lambda, \\ \begin{pmatrix} 1 & \bar{C}_n(z - \bar{\eta}_n)^{-1}T^2(z)e^{-2it\bar{\theta}_n} \\ 0 & 1 \end{pmatrix}, & z \in \bar{\mathbb{P}}_n, n \in \nabla \setminus \Lambda, \\ \begin{pmatrix} 1 & 0 \\ \bar{C}_n^{-1}(z - \bar{\eta}_n)T^{-2}(z)e^{2it\bar{\theta}_n} & 1 \end{pmatrix}, & z \in \bar{\mathbb{P}}_n, n \in \Delta \setminus \Lambda. \end{cases} \quad (4.23)$$

(IV) *Asymptotic behavior:*

$$M^{(1)}(z) = I + O(z^{-1}), z \rightarrow \infty \text{ (and } z \rightarrow 0 \text{ by symmetry)}, \quad (4.24)$$

$$M^{(1)}(z) = \left(\text{diag}(a_1(y, t), a_1^{-1}(y, t)) + \begin{pmatrix} 0 & a_2(y, t) \\ a_3(y, t) & 0 \end{pmatrix} (z - i) \right) T(i)^{\sigma_3} (I - T_0(\xi)(z - i)) + O((z - i)^2), \quad (4.25)$$

where $a_j(y, t)$, $j = 1, 2, 3$ are real-valued functions from the expansion of $M^{(1)}(z)$ at $z = i$.

(V) *Residue conditions:* The matrix $M^{(1)}(z)$ has simple poles at η_n and $\bar{\eta}_n$ with

$$\text{Res}_{\eta_n} M^{(1)}(z) = \lim_{z \rightarrow \eta_n} M^{(1)}(z) \begin{pmatrix} 0 & 0 \\ c_n T^2(z) e^{2it\theta(\eta_n)} & 0 \end{pmatrix}, \quad (4.26a)$$

$$\text{Res}_{\bar{\eta}_n} M^{(1)}(z) = \lim_{z \rightarrow \bar{\eta}_n} M^{(1)}(z) \begin{pmatrix} 0 & \bar{c}_n T^{-2}(z) e^{-2it\bar{\theta}(\eta_n)} \\ 0 & 0 \end{pmatrix}. \quad (4.26b)$$

4.1. Contour deformation. In this section, our attention will turn to removing jump conditions of $M^{(1)}(z)$ on the real axis \mathbb{R} taking into account the fact that the growth and decay properties of the exponential functions $e^{\pm 2it\theta}$.

To that end, A fixed angle ψ is sufficiently small to satisfy the following conditions

- (i) For $\xi > 2$, then $\cos 2\psi > \frac{4}{\xi} - 1$.
- (ii) For $\xi < -\frac{1}{4}$, then $\cos 2\psi > -\frac{1}{\xi} - 1$.

For the regions $\xi < -\frac{1}{4}$ and $\xi > 2$, we define the $\Omega = \cup_1^4 \Omega_k$, where

$$\begin{aligned} \Omega_{2n+1} &= \{z \in \mathbb{C} | n\pi \leq \arg z \leq n\pi + \psi\}, \\ \Omega_{2n+2} &= \{z \in \mathbb{C} | (n+1)\pi - \psi \leq \arg z \leq (n+1)\pi\}, \end{aligned}$$

with $n = 0, 1$, which such that the boundary values

$$\Sigma_k = e^{(k-1)i\pi/2+i\psi}\mathbb{R}^+, \quad k = 1, 3, \quad (4.27)$$

$$\Sigma_k = e^{ki\pi/2-i\psi}\mathbb{R}^+, \quad k = 2, 4, \quad (4.28)$$

shown in Fig. 3. Let

$$\Sigma^{(2)}(\xi) = \bigcup_{n \in N \setminus \Lambda} (\partial \overline{\mathbb{P}}_n \cup \partial \mathbb{P}_n). \quad (4.29)$$

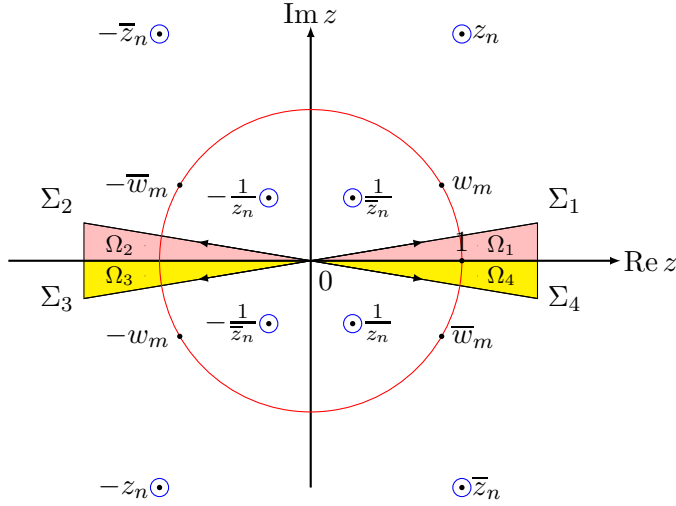

FIGURE 3. The unknown matrix-valued function $M^{(2)}(z)$ has nonzero $\bar{\partial}$ -derivatives in Ω_k , and has jump conditions on $\mathbb{P}_n \cup \overline{\mathbb{P}}_n$. $M^{(2)}(z)$ is continuous on the contour Σ_k , where Σ_k denote the boundary values of Ω_k .

Proposition 4.3. *Let $F(s) = s + \frac{1}{s}$ be real function for $s \in \mathbb{R}$, then the imaginary part of phase function $\theta(z)$ satisfies the following inequalities:*

For the case $\xi \in (2, \infty)$,

$$\operatorname{Im} \theta(z) \geq |\sin \psi| F(|z|) \left(\frac{\xi}{4} - \frac{1}{\cos 2\psi + 1} \right), \quad z \in \Omega_1 \cup \Omega_2, \quad (4.30a)$$

$$\operatorname{Im} \theta(z) \leq -|\sin \psi| F(|z|) \left(\frac{\xi}{4} - \frac{1}{\cos 2\psi + 1} \right), \quad z \in \Omega_3 \cup \Omega_4, \quad (4.30b)$$

For the case $\xi \in (-\infty, -1/4)$,

$$\operatorname{Im} \theta(z) \leq -|\sin \psi| F(|z|) \left(-\frac{\xi}{4} - \frac{1}{4(\cos 2\psi + 1)} \right), \quad z \in \Omega_1 \cup \Omega_2, \quad (4.31a)$$

$$\operatorname{Im} \theta(z) \geq |\sin \psi| F(|z|) \left(-\frac{\xi}{4} - \frac{1}{4(\cos 2\psi + 1)} \right), \quad z \in \Omega_3 \cup \Omega_4. \quad (4.31b)$$

Proof. Taking the region Ω_1 as an example, it can be proved that other regions are similar with the same method. Let $z = |z|e^{i\phi}$ and $F(|z|) = |z| + \frac{1}{|z|}$, then the phase function $\theta(z)$ (3.2) can be written as

$$\operatorname{Im} \theta(z) = -F(|z|) \sin \phi \left(-\frac{\xi}{4} + \frac{4 \cos 2\phi - 2F(|z|)^2 + 12}{(F(|z|)^2 + 2 \cos 2\phi - 2)^2} \right). \quad (4.32)$$

As in [69], considering the maximum and minimum values of

$$H(|z|, \phi) := \frac{4 \cos 2\phi - 2F(|z|)^2 + 12}{(F(|z|)^2 + 2 \cos 2\phi - 2)^2}$$

yields $H(|z|, \phi) \in (-\frac{1}{4(\cos 2\phi+1)}, \frac{1}{\cos 2\phi+1})$, which completes the proof of Proposition 4.3. \square

Corollary 4.4. *Let $\xi \in (-\infty, -1/4) \cup (2, +\infty)$. For $z = |z|e^{i\phi} = u + iv$, there exists a constant $\tau(\xi)$ such that:*

For the case $\xi \in (2, \infty)$,

$$\operatorname{Im} \theta(z) \geq \tau(\xi)v, \quad z \in \Omega_1 \cup \Omega_2, \quad (4.33a)$$

$$\operatorname{Im} \theta(z) \leq -\tau(\xi)v, \quad z \in \Omega_3 \cup \Omega_4. \quad (4.33b)$$

For the case $\xi \in (-\infty, -1/4)$,

$$\operatorname{Im} \theta(z) \leq -\tau(\xi)v, \quad z \in \Omega_1 \cup \Omega_2, \quad (4.34a)$$

$$\operatorname{Im} \theta(z) \geq \tau(\xi)v, \quad z \in \Omega_3 \cup \Omega_4. \quad (4.34b)$$

In what follows, we will turn our attention to the continuous continuation of the jump matrix $V^{(1)}(z)$. For this purpose, we first define

$$r_1(z, \xi) = r_2(z, \xi) = \begin{cases} \bar{r}(z), & \xi > 2, \\ -\frac{r(z)}{1 - |r(z)|^2}, & \xi < -1/4. \end{cases} \quad (4.35)$$

$$r_3(z, \xi) = r_4(z, \xi) = \begin{cases} r(z), & \xi > 2, \\ -\frac{\bar{r}(z)}{1 - |r(z)|^2}, & \xi < -1/4. \end{cases} \quad (4.36)$$

In order to eliminate the jump on the real axis \mathbb{R} and generate two steepest descent lines, it is necessary to introduce the matrix $R^{(2)}(z)$ with good $\bar{\partial}$ -derivatives.

For $\xi \in (2, +\infty)$:

$$R^{(2)}(z, \xi) = \begin{cases} \begin{pmatrix} 1 & 0 \\ R_j(z, \xi)e^{2it\theta} & 1 \end{pmatrix}, & z \in \Omega_j, j = 1, 2, \\ \begin{pmatrix} 1 & R_j(z, \xi)e^{-2it\theta} \\ 0 & 1 \end{pmatrix}, & z \in \Omega_j, j = 3, 4, \\ I, & \text{elsewhere;} \end{cases} \quad (4.37)$$

For $\xi \in (-\infty, -1/4)$:

$$R^{(2)}(z, \xi) = \begin{cases} \begin{pmatrix} 1 & R_j(z, \xi)e^{-2it\theta} \\ 0 & 1 \end{pmatrix}, & z \in \Omega_j, j = 1, 2, \\ \begin{pmatrix} 1 & 0 \\ R_j(z, \xi)e^{2it\theta} & 1 \end{pmatrix}, & z \in \Omega_j, j = 3, 4, \\ I, & \text{elsewhere,} \end{cases} \quad (4.38)$$

where the functions $R_j(z, \xi)$, $j = 1, 2, 3, 4$ are defined in the following proposition.

Proposition 4.5. *The functions $R_j(z, \xi) : \overline{\Omega} \rightarrow \mathbb{C}$ have the boundary values:*

For $\xi \in (2, +\infty)$:

$$R_1(z, \xi) = \begin{cases} r_1(z, \xi)T(z)^{-2}, & z \in \mathbb{R}^+, \\ 0, & z \in \Sigma_1, \end{cases} \quad (4.39a)$$

$$R_2(z, \xi) = \begin{cases} r_2(z, \xi)T(z)^{-2}, & z \in \mathbb{R}^-, \\ 0, & z \in \Sigma_2, \end{cases} \quad (4.39b)$$

$$R_3(z, \xi) = \begin{cases} r_3(z, \xi)T(z)^2, & z \in \mathbb{R}^-, \\ 0, & z \in \Sigma_3, \end{cases} \quad (4.39c)$$

$$R_4(z, \xi) = \begin{cases} r_4(z, \xi)T(z)^2, & z \in \mathbb{R}^+, \\ 0, & z \in \Sigma_4, \end{cases} \quad (4.39d)$$

for the case $\xi \in (-\infty, -1/4)$,

$$R_1(z, \xi) = \begin{cases} r_1(z, \xi)T_+(z)^2, & z \in \mathbb{R}^+, \\ 0, & z \in \Sigma_1, \end{cases} \quad (4.40a)$$

$$R_2(z, \xi) = \begin{cases} r_2(z, \xi)T_+(z)^2, & z \in \mathbb{R}^-, \\ 0, & z \in \Sigma_2, \end{cases} \quad (4.40b)$$

$$R_3(z, \xi) = \begin{cases} r_3(z, \xi)T_-(z)^{-2}, & z \in \mathbb{R}^-, \\ 0, & z \in \Sigma_3, \end{cases} \quad (4.40c)$$

$$R_4(z, \xi) = \begin{cases} r_4(z, \xi)T_-(z)^{-2}, & z \in \mathbb{R}^+, \\ 0, & z \in \Sigma_4, \end{cases} \quad (4.40d)$$

where the matrix-valued functions $R_k(z, \xi)$ such that for $k = 1, 2, 3, 4$

$$|\bar{\partial}R_k(z, \xi)| \lesssim |r'_k(|z|)| + |z|^{-1/2}, \quad z \in \Omega_k, \quad (4.41)$$

furthermore

$$|\bar{\partial}R_k(z, \xi)| \lesssim |r'_k(|z|)| + |z|^{-1}, \quad z \in \Omega_k, \quad (4.42)$$

$$|\bar{\partial}R_k(z, \xi)| \equiv 0, \quad z \in \text{elsewhere}. \quad (4.43)$$

Proof. Taking $R_1(z, \xi)$ in the region $\xi \in (2, +\infty)$ as example, it can be proved that other situations are similar. We now construct a new function

$$f_1(z) = r_1(|z|)T^{-2}(z) \cos(z_0 \arg z), \quad z_0 = \frac{\pi}{z\phi}. \quad (4.44)$$

Let $z = \rho e^{i\phi}$. Observing that the function (4.44) has the same boundary values on the contour Σ_1 and \mathbb{R} , which means that the function we construct is appropriate. Applying the fact that $\bar{\partial} = \frac{e^{i\phi}}{2}(\partial_\rho + i\rho\partial_\phi)$ to the function $f_1(z)$ yields that

$$\bar{\partial}f_1(z) = \frac{e^{i\phi}}{2}T^{-2}(z) \left(r'_1(\rho) \cos(z_0\phi) - \frac{iz_0}{\rho} r_1(\rho) \sin(z_0\phi) \right). \quad (4.45)$$

It follows from the boundedness of functions $T(z)$ and $T(z)^{-1}$ that

$$|\bar{\partial}f_1(z)| \leq |r'_1(|z|)| + \left| \frac{r_1(|z|)}{|z|} \right|. \quad (4.46)$$

On the other hand,

$$\begin{aligned} |r_1(|z|)| &= |r_1(|z|) - r_1(0)| = \left| \int_0^{|z|} r'_1(s) ds \right| \\ &\leq \|r'_1(s)\|_{L^2(\mathbb{R})} |z|^{1/2} \lesssim |z|^{1/2}. \end{aligned} \quad (4.47)$$

Combining the inequality (4.47) with (4.46) yields (4.41). Additionally, Observing the fact $r_1(|z|) \in L^\infty$, one has (4.42), which completes the proof of the proposition. \square

Based on the above analysis, a new unknown function $M^{(2)}(z) := M^{(2)}(y, t, z)$ can be further defined by $R^{(2)}(z)$ as follows

$$M^{(2)}(z) = M^{(1)}(z)R^{(2)}(z), \quad (4.48)$$

which solves a mixed RH problem.

RH Problem 4.6. Find a matrix-valued function $M^{(2)}(z)$ satisfy the following conditions:

- (I) The function $M^{(2)}(z)$ is continuous in $\mathbb{C} \setminus \Sigma^{(2)}$ and takes continuous boundary values $M_{\pm}^{(2)}(z)$ on $\Sigma^{(2)}$ from the left (respectively right).
- (II) $M^{(2)}(z) = \sigma_1 \overline{M^{(2)}(\bar{z})} \sigma_1 = \sigma_2 M^{(2)}(-z) \sigma_2 = \sigma_1 M^{(2)}(z^{-1}) \sigma_1$.
- (III) Jump condition: The non-tangential limits $M_{\pm}^{(2)}(z)$ for $z \in \mathbb{R} \setminus \{\pm 1\}$

$$M_+^{(2)}(z) = M_-^{(2)}(z)V^{(2)}(z), \quad z \in \Sigma^{(2)}, \quad (4.49)$$

where the jump matrix $V^{(2)}(z)$ is defined by

$$V^{(2)}(z) = \begin{cases} \begin{pmatrix} 1 & 0 \\ -C_n(z - \eta_n)^{-1}T^{-2}(z)e^{2it\theta_n} & 1 \end{pmatrix}, & z \in \mathbb{P}_n, n \in \nabla \setminus \Lambda, \\ \begin{pmatrix} 1 & -C_n^{-1}(z - \eta_n)T^2(z)e^{-2it\theta_n} \\ 0 & 1 \end{pmatrix}, & z \in \mathbb{P}_n, n \in \Delta \setminus \Lambda, \\ \begin{pmatrix} 1 & \bar{C}_n(z - \bar{\eta}_n)^{-1}T^2(z)e^{-2it\bar{\theta}_n} \\ 0 & 1 \end{pmatrix}, & z \in \bar{\mathbb{P}}_n, n \in \nabla \setminus \Lambda, \\ \begin{pmatrix} 1 & 0 \\ \bar{C}_n^{-1}(z - \bar{\eta}_n)T^{-2}(z)e^{2it\bar{\theta}_n} & 1 \end{pmatrix}, & z \in \bar{\mathbb{P}}_n, n \in \Delta \setminus \Lambda. \end{cases} \quad (4.50)$$

(IV) *Asymptotic behavior:*

$$M^{(2)}(z) = I + O(z^{-1}), z \rightarrow \infty \text{ (and } z \rightarrow 0 \text{ by symmetry)}, \quad (4.51)$$

$$M^{(2)}(z) = \begin{pmatrix} a_1(y, t) & 0 \\ 0 & a_1^{-1}(y, t) \end{pmatrix} + \begin{pmatrix} 0 & a_2(y, t) \\ a_3(y, t) & 0 \end{pmatrix} (z - i) + O((z - i)^2), \quad (4.52)$$

where $a_j(y, t)$, $j = 1, 2, 3$ are real-valued functions from the expansion of $M^{(2)}(z)$ at $z = i$.

(V) *Residue conditions:* The matrix $M^{(2)}(z)$ has simple poles at η_n and $\bar{\eta}_n$ with

$$\text{Res}_{\eta_n} M^{(2)}(z) = \lim_{z \rightarrow \eta_n} M^{(2)}(z) \begin{pmatrix} 0 & 0 \\ c_n T^2(z) e^{2it\theta(\eta_n)} & 0 \end{pmatrix}, \quad (4.53a)$$

$$\text{Res}_{\bar{\eta}_n} M^{(2)}(z) = \lim_{z \rightarrow \bar{\eta}_n} M^{(2)}(z) \begin{pmatrix} 0 & \bar{c}_n T^{-2}(z) e^{-2it\bar{\theta}(\eta_n)} \\ 0 & 0 \end{pmatrix}. \quad (4.53b)$$

(VI) *The $\bar{\partial}$ -derivative:* For $z \in \mathbb{C}$

$$\bar{\partial} M^{(2)}(z) = M^{(2)}(z) \bar{\partial} R^{(2)}(z), \quad (4.54)$$

where for $\xi \in (2, +\infty)$

$$\bar{\partial} R^{(2)}(z) = \begin{cases} \begin{pmatrix} 0 & 0 \\ \bar{\partial} R_j(z, \xi) e^{2it\theta} & 0 \end{pmatrix}, & z \in \Omega_j, j = 1, 2, \\ \begin{pmatrix} 0 & \bar{\partial} R_j(z, \xi) e^{-2it\theta} \\ 0 & 0 \end{pmatrix}, & z \in \Omega_j, j = 3, 4, \\ \mathbf{0}, & z \in \text{elsewhere}, \end{cases}$$

for $\xi \in (-\infty, -1/4)$

$$\bar{\partial} R^{(2)}(z) = \begin{cases} \begin{pmatrix} 0 & \bar{\partial} R_j(z, \xi) e^{-2it\theta} \\ 0 & 0 \end{pmatrix}, & z \in \Omega_j, j = 1, 2, \\ \begin{pmatrix} 0 & \bar{\partial} R_j(z, \xi) e^{2it\theta} \\ 0 & 0 \end{pmatrix}, & z \in \Omega_j, j = 3, 4, \\ \mathbf{0}, & z \in \text{elsewhere}. \end{cases}$$

4.2. Decomposition of mixed RH problem. In this section, RH problem 4.6 will be solved according to the classification of $\bar{\partial}$ -derivatives $\bar{\partial}R^{(2)}(z)$. One is that $\bar{\partial}R^{(2)}(z) \equiv 0$ corresponds to the pure soliton solution $M^{(rhp)}(z)$, and the other is that $\bar{\partial}R^{(2)}(z) \neq 0$ corresponds to the pure $\bar{\partial}$ -problem $M^{(3)}(z)$, which can be solved by double integral. First, consider the pure RH problem, that is, the corresponding $\bar{\partial}$ -derivative $\bar{\partial}R^{(2)}(z)$ is constant to zero.

RH Problem 4.7. *A matrix-valued function $M^{(rhp)}(z) := M^{(rhp)}(y, t, z)$ with the same symmetry, analytic property and asymptotic property as $M^{(2)}(z)$ satisfies the following conditions*

(1) *Jump condition: The non-tangential limits $M_{\pm}^{(rhp)}(z)$ for $z \in \mathbb{R} \setminus \{\pm 1\}$*

$$M_{+}^{(rhp)}(z) = M_{-}^{(rhp)}(z)V^{(rhp)}(z), \quad z \in \Sigma^{(2)}, \quad (4.55)$$

where the jump matrix $V^{(rhp)}(z)$ is defined by (4.50).

(2) *The $\bar{\partial}$ -derivative: For $z \in \mathbb{C}$, $\bar{\partial}R^{(2)}(z) \equiv 0$.*

(3) *Residue conditions: The matrix $M^{(rhp)}(z)$ has simple poles at η_n and $\bar{\eta}_n$ with*

$$\operatorname{Res}_{\eta_n} M^{(rhp)}(z) = \lim_{z \rightarrow \eta_n} M^{(rhp)}(z) \begin{pmatrix} 0 & 0 \\ c_n T^2(z) e^{2it\theta(\eta_n)} & 0 \end{pmatrix}, \quad (4.56a)$$

$$\operatorname{Res}_{\bar{\eta}_n} M^{(rhp)}(z) = \lim_{z \rightarrow \bar{\eta}_n} M^{(rhp)}(z) \begin{pmatrix} 0 & \bar{c}_n T^{-2}(z) e^{-2it\bar{\theta}(\eta_n)} \\ 0 & 0 \end{pmatrix}. \quad (4.56b)$$

The pure $\bar{\partial}$ -problem can be obtained by removing the soliton component $M^{(rhp)}(z)$

$$M^{(3)}(z) = M^{(2)}(z)M^{(rhp)}(z)^{-1}, \quad (4.57)$$

which solves the following pure $\bar{\partial}$ -problem.

$\bar{\partial}$ -Problem 4.8. *Find a matrix-valued function $M^{(3)}(z)$ such that*

(I) *$M^{(3)}(z)$ is continuous in \mathbb{C} , and analytic in $\mathbb{C} \setminus \bar{\Omega}$.*

(II) *$M^{(3)}(z) \rightarrow I$ as $z \rightarrow \infty$.*

(III) *$\bar{\partial}$ -derivative: For $z \in \mathbb{C}$, one has*

$$\bar{\partial}M^{(3)}(z) = M^{(3)}(z)W^{(3)}(z), \quad (4.58)$$

where $W^{(3)}(z) = M^{(rhp)}(z)\bar{\partial}R^{(2)}(z)M^{(rhp)}(z)^{-1}$.

Proof. The analytic properties of $M^{(3)}(z)$ can be obtained by using the properties of $M^{(2)}(z)$ and $M^{(rhp)}(z)$ in RH problems 4.6 and 4.7, respectively. Observing that $M^{(2)}(z)$ and $M^{(rhp)}(z)$ have the same jump conditions $V^{(2)}(z)$ and $V^{(rhp)}(z)$ ($V^{(2)}(z) \equiv V^{(rhp)}(z)$), then

$$\begin{aligned} M_{-}^{(3)}(z)^{-1}M_{+}^{(3)}(z) &= M_{-}^{(2)}(z)^{-1}M_{-}^{(rhp)}(z)M_{+}^{(rhp)}(z)^{-1}M_{+}^{(2)}(z) \\ &= M_{-}^{(2)}(z)^{-1}V^{(2)}(z)^{-1}M_{+}^{(2)}(z) = I, \end{aligned}$$

which means that $M^{(3)}(z)$ is no jump condition and is continuous. Meanwhile, $M^{(3)}(z)$ has no poles for $\xi \in \{\eta_n, \bar{\eta}_n\}$ with $n \in \Lambda$. Let A_{ξ} be the nilpotent matrix appearing in the residue conditions of

RH problems 4.6 and 4.7, and then we have a local expansion in the neighborhood of ξ

$$\begin{aligned} M^{(2)}(z) &= \alpha(\xi) \left[\frac{A_\xi}{z-\xi} + I \right] + \mathcal{O}(z-\xi), \\ M^{(rhp)}(z) &= \beta(\xi) \left[\frac{A_\xi}{z-\xi} + I \right] + \mathcal{O}(z-\xi), \end{aligned}$$

where $\alpha(\xi)$ and $\beta(\xi)$ are constant coefficients of the corresponding expansion respectively. Taking the product yields that $M^{(3)}(z) = \mathcal{O}(1)$, which indicates that the poles of $M^{(3)}(z)$ are removable and $M^{(3)}(z)$ is boundary locally. The proof of $\bar{\partial}$ -derivative for $M^{(3)}(z)$ follows the following process

$$\begin{aligned} \bar{\partial}M^{(3)}(z) &= \bar{\partial}(M^{(2)}(z)M^{(rhp)}(z)^{-1}) = M^{(2)}(z)\bar{\partial}R^{(2)}(z)M^{(rhp)}(z)^{-1} \\ &= M^{(2)}(z)M^{(rhp)}(z)^{-1}M^{(rhp)}(z)\bar{\partial}R^{(2)}(z)M^{(rhp)}(z)^{-1} \\ &= M^{(3)}(z)M^{(rhp)}(z)\bar{\partial}R^{(2)}(z)M^{(rhp)}(z)^{-1} \triangleq M^{(3)}(z)W^{(3)}(z). \end{aligned}$$

□

4.3. Asymptotic of N -soliton solution. In this section, the solution of the original RH problem 2.6 without reflection will be established to approximate the solution of RH problem 4.7. For $\bar{\partial}R^{(2)}(z) = 0$, RH problem 4.6 is reduced to RH problem 4.7. The existence and uniqueness of solutions of RH problem 4.7 can be guaranteed by connecting the solution of RH problem 4.7 with the original RH problem 2.6.

Proposition 4.9. *Let $M^{(rhp)}(z)$ be the solution to RH problem 4.7 with $\bar{\partial}R^{(2)}(z) \equiv 0$. For the scattering data $\{r(z), (c_n, \eta_n)_{n \in N}\}$ in RH problem 4.7, the solution to RH problem 4.7 exists and is equivalent to the solution to RH problem 2.6 with reflection-less scattering data $\{0, (\tilde{c}_n, \eta_n)_{n \in N}\}$, where the modified connection coefficients $\tilde{c}_n := \tilde{c}_n(x, t)$ are defined by*

$$\tilde{c}_n = c_n \exp \left(-\frac{1}{i\pi} \int_{\Sigma_b(\xi)} \frac{\ln(1 - |r(s)|^2)}{s - z} ds \right), \quad (4.59)$$

where $r(z)$ is reflection coefficient defined by Proposition 2.3.

Proof. With $\bar{\partial}R^{(2)}(z) \equiv 0$, then the RH problem 4.7 for $M^{(rhp)}(z)$ degenerates into a piecewise meromorphic function with discontinuous jumps on the contour $\Sigma^{(2)}$. Observing the solutions $M^{(rhp)}(z)$ and $M(z)$, we need restore the poles at η_n and $\bar{\eta}_n$ for $M^{(rhp)}(z)$. Reversing the triangularity effected by (4.4) and (4.21) yields that

$$M^{(b)}(z) = M^{(rhp)}(z)G(z) \left(\prod_{n \in \Delta} \frac{z - \eta_n}{\bar{\eta}_n^{-1}z - 1} \right)^{-\sigma_3}, \quad (4.60)$$

where

$$G(z) = \begin{cases} \begin{pmatrix} 1 & 0 \\ C_n(z - \eta_n)^{-1} e^{2it\theta_n} & 1 \end{pmatrix}, & z \in \mathbb{P}_n, n \in \nabla \setminus \Lambda, \\ \begin{pmatrix} 1 & C_n^{-1}(z - \eta_n) e^{-2it\theta_n} \\ 0 & 1 \end{pmatrix}, & z \in \mathbb{P}_n, n \in \Delta \setminus \Lambda, \\ \begin{pmatrix} 1 & -\bar{C}_n(z - \bar{\eta}_n)^{-1} e^{-2it\bar{\theta}_n} \\ 0 & 1 \end{pmatrix}, & z \in \bar{\mathbb{P}}_n, n \in \nabla \setminus \Lambda, \\ \begin{pmatrix} 1 & 0 \\ -\bar{C}_n^{-1}(z - \bar{\eta}_n) e^{2it\bar{\theta}_n} & 1 \end{pmatrix}, & z \in \bar{\mathbb{P}}_n, n \in \Delta \setminus \Lambda. \end{cases}$$

It follows from the transformation (4.60) that for the origin and infinity, $M^{(h)}(z)$ preserves the normalization conditions. Comparing with (4.21), the transformation (4.60) recovers the jump conditions on the circles \mathbb{P}_n and $\bar{\mathbb{P}}_n$ with $n \notin \Lambda$. For $n \in \Lambda$, it can be verified that $M^{(h)}(z)$ satisfies residue formula (4.56a) with modified connection coefficient. Taking η_n as example,

$$\begin{aligned} \operatorname{Res}_{\eta_n} M^{(h)}(z) &= \operatorname{Res}_{\eta_n} M^{(rhp)}(z) G(z) \left(\prod_{n \in \Delta} \frac{z - \eta_n}{\bar{\eta}_n^{-1} z - 1} \right)^{-\sigma_3}, \\ &= \lim_{z \rightarrow \eta_n} M^{(rhp)}(z) \begin{pmatrix} 0 & 0 \\ c_n T^2(z) e^{2it\theta(\eta_n)} & 0 \end{pmatrix} G(z) \left(\prod_{n \in \Delta} \frac{z - \eta_n}{\bar{\eta}_n^{-1} z - 1} \right)^{-\sigma_3}, \\ &= \lim_{z \rightarrow \eta_n} M^{(h)}(z) \begin{pmatrix} 0 & 0 \\ c_n e^{2it\theta} T^2(z) \left(\prod_{n \in \Delta} \frac{z - \eta_n}{\bar{\eta}_n^{-1} z - 1} \right)^2 & 0 \end{pmatrix}, \\ &= \lim_{z \rightarrow \eta_n} M^{(h)}(z) \begin{pmatrix} 0 & 0 \\ \tilde{c}_n e^{2it\theta} & 0 \end{pmatrix}. \end{aligned} \quad (4.61)$$

The analyticity and symmetry of $M^{(h)}(z)$ can be derived by the properties of $M^{(rhp)}(z)$, $T(z)$, and $G(z)$. On the other hand, although $M^{(h)}(z)$ has no normalization condition at singularity i , singularity i is not the pole of $M^{(h)}(z)$, which means that the singularity does not affect $M^{(rhp)}(z)$. In conclusion, we know that $M^{(h)}(z)$ is the solution of RH problem 2.6 under the condition of no reflection. Its uniqueness comes from Liouville's theorem, which leads to the uniqueness and existences of $M^{(h)}(z)$ from transformation (4.60). \square

Proposition 4.9 shows the existence and uniqueness of the solution of $M^{(rhp)}(z)$, but since the discrete spectra are distributed in the whole complex plane, the contribution of the discrete spectra to the solution needs to be further considered. As in [19], the jump condition $V^{(2)}(z)$ such that

$$\left\| V^{(2)}(z) - I \right\|_{L^p(\Sigma^{(2)})} \lesssim K_p e^{-2\varepsilon_0 t}, 1 \leq p \leq \infty \quad (4.62)$$

where $\varepsilon_0 = \min_{n \in N \setminus \Lambda} \{|\operatorname{Im} \theta|\}$ and $K_p \geq 0$ are constants independent of (y, t) , which implies that the jump matrix $V^{(2)}(z)$ on the disks \mathbb{P}_n uniformly converges to the identity matrix, and the contribution

of these discrete spectra to the solution can be ignored. The proof of inequality (4.62) can be briefly described as follows. Taking $z \in \mathbb{P}_n$ with $n \in \nabla$ and $p = \infty$ as example, it follows from (4.49) that

$$\begin{aligned} \left\| V^{(2)}(z) - I \right\|_{L^\infty(\Sigma^{(2)})} &= \left| c_n(z - \eta_n)^{-1} T(z)^2 e^{2it\theta} \right| \\ &\lesssim e^{\operatorname{Re}(2it\theta)} = e^{-2t \operatorname{Im} \theta} \lesssim e^{-2\varepsilon_0 t}. \end{aligned} \quad (4.63)$$

In these inequalities, use has been made of the fact that for $n \in \nabla$, then $\operatorname{Im} \theta > 0$. At the same time, the estimation of jump matrix $V^{(2)}(z)$ (4.62) further encourages us to decompose matrix $M^{(rhp)}(z)$ into the following form

$$M^{(rhp)}(z) = M^{(err)}(z)M^{(sol)}(z), \quad (4.64)$$

where $E(z)$ is error function solved by small-norm RH problem as [29, 30, 44] and RH problem 4.7 for $M^{(rhp)}(z)$ reduces to a new RH problem for $M^{(sol)}(z)$ as $V^{(2)}(z) = 0$.

RH Problem 4.10. Find a matrix-valued function $M^{(sol)}(z)$ such that

- (I) The function $M^{(sol)}(z)$ is analytic in $\mathbb{C} \setminus \{\eta_n, \bar{\eta}_n\}_{n \in \Lambda}$.
- (II) $M^{(sol)}(z) = I + O(z^{-1})$ as $z \rightarrow \infty$.
- (III) For $n \in \Lambda$, the function $M^{(sol)}(z)$ is of simple poles at η_n and $\bar{\eta}_n$ with

$$\operatorname{Res}_{\eta_n} M^{(sol)}(z) = \lim_{z \rightarrow \eta_n} M^{(sol)}(z) \begin{pmatrix} 0 & 0 \\ c_n T^2(z) e^{2it\theta(\eta_n)} & 0 \end{pmatrix}, \quad (4.65a)$$

$$\operatorname{Res}_{\bar{\eta}_n} M^{(sol)}(z) = \lim_{z \rightarrow \bar{\eta}_n} M^{(sol)}(z) \begin{pmatrix} 0 & \bar{c}_n T^{-2}(z) e^{-2it\bar{\theta}(\eta_n)} \\ 0 & 0 \end{pmatrix}. \quad (4.65b)$$

The unique solution of RH problem 4.10 is embodied in Proposition 4.11 and as $z \rightarrow i$, one has

$$M^{(sol)}(z) = M^{(sol)}(i) + M_1^{(sol)}(z - i) + O((z - i)^2). \quad (4.66)$$

Proposition 4.11. The solution $M^{(sol)}(z)$ to RH problem 4.10 is equivalent to the original RH problem 2.6 with reflection-less and modified scattering data $\{0, \{\eta_n, C_n T^2(\eta_n)\}_{n \in \Lambda}\}$.

(1) As $\Lambda = \emptyset$, then

$$M^{(sol)}(z) = I + \frac{i\hat{\alpha}_+}{2(z-1)} \begin{pmatrix} -1 & 1 \\ -1 & 1 \end{pmatrix} - \frac{i\hat{\alpha}_+}{2(z+1)} \begin{pmatrix} 1 & 1 \\ -1 & -1 \end{pmatrix}. \quad (4.67)$$

(2) As $\Lambda \neq \emptyset$, and $\Lambda = \{\eta_{j_k}\}_{k=1}^N$, then

$$\begin{aligned} M^{(sol)}(z) &= I + \frac{i\hat{\alpha}_+}{2(z-1)} \begin{pmatrix} -1 & 1 \\ -1 & 1 \end{pmatrix} - \frac{i\hat{\alpha}_+}{2(z+1)} \begin{pmatrix} 1 & 1 \\ -1 & -1 \end{pmatrix} \\ &\quad + \sum_{k=1}^N \begin{pmatrix} \frac{\alpha_k}{z-\eta_{j_k}} & \frac{\bar{\beta}_k}{z-\bar{\eta}_{j_k}} \\ \frac{\beta_k}{z-\eta_{j_k}} & \frac{\bar{\alpha}_k}{z-\bar{\eta}_{j_k}} \end{pmatrix}, \end{aligned} \quad (4.68)$$

where the coefficients α_k and β_k satisfy that for the discrete spectrum $\{z_n, -\bar{z}_n\}_{n=1}^{N_1}$, $\{z_n^{-1}, -\bar{z}_n^{-1}\}_{n=N_1+1}^{2N_1}$ and $\{w_n, -\bar{w}_n\}_{n=2N_1+1}^{2N_1+N_2}$, then $\alpha_k = -\bar{\alpha}_{k+n}$ and $\beta_k = \bar{\beta}_{k+n}$, which are determined by the system

$$\alpha_k c_{j_k}^{-1} T(\eta_{j_k})^{-2} e^{-2it\theta} = \frac{i\hat{\alpha}_+}{2(z-1)} + \frac{i\hat{\alpha}_+}{2(z-1)} + \sum_{h=1}^N \frac{\bar{\eta}_h}{\eta_{j_k} - \eta_{j_h}}, \quad (4.69a)$$

$$\beta_k c_{j_k}^{-1} T(\eta_{j_k})^{-2} e^{-2it\theta} = 1 + \frac{i\hat{\alpha}_+}{2(z-1)} - \frac{i\hat{\alpha}_+}{2(z-1)} + \sum_{h=1}^N \frac{\bar{\alpha}_h}{\eta_{j_k} - \eta_{j_h}}. \quad (4.69b)$$

Proof. For the case $\Lambda = \emptyset$, the conclusion is obvious, so next we turn our attention mainly to proving case $\Lambda \neq \emptyset$. For convenience, only the case of out of circle discrete spectrum is considered, thus $M^{(sol)}(z)$ has the following expansion form

$$M^{(sol)}(z) = I + \frac{i\hat{\alpha}_+}{2(z-1)} \begin{pmatrix} -c & 1 \\ -c & 1 \end{pmatrix} - \frac{i\hat{\alpha}_+}{2(z+1)} \begin{pmatrix} 1 & 1 \\ -c & -c \end{pmatrix} + \sum_{k=1}^N \left(\begin{array}{cccc} \frac{c_k^1}{z-z_k} + \frac{c_k^2}{z+\bar{z}_k} + \frac{c_k^3}{z+z_k^{-1}} + \frac{c_k^3}{z-\bar{z}_k^{-1}} & \frac{\tilde{c}_k^1}{z-\bar{z}_k} + \frac{\tilde{c}_k^2}{z+z_k} + \frac{\tilde{c}_k^3}{z+\bar{z}_k^{-1}} + \frac{\tilde{c}_k^3}{z-z_k^{-1}} \\ \frac{c_k^5}{z-z_k} + \frac{c_k^6}{z+\bar{z}_k} + \frac{c_k^7}{z+z_k^{-1}} + \frac{c_k^8}{z-\bar{z}_k^{-1}} & \frac{\tilde{c}_k^5}{z-\bar{z}_k} + \frac{\tilde{c}_k^6}{z+z_k} + \frac{\tilde{c}_k^7}{z+\bar{z}_k^{-1}} + \frac{\tilde{c}_k^8}{z-z_k^{-1}} \end{array} \right). \quad (4.70)$$

It follows from the symmetry $M_1^{(sol)}(-z) = \sigma_3 \sigma_1 M_2^{(sol)}(z)$ that $c = 1$ and

$$\begin{aligned} \tilde{c}_k^6 &= -c_k^1, & \tilde{c}_k^5 &= -c_k^2, & \tilde{c}_k^8 &= -c_k^3, & \tilde{c}_k^7 &= -c_k^4, \\ \tilde{c}_k^1 &= c_k^6, & \tilde{c}_k^2 &= c_k^5, & \tilde{c}_k^3 &= c_k^8, & \tilde{c}_k^4 &= c_k^7. \end{aligned} \quad (4.71)$$

On the other hand, applying the symmetry $M_1^{(sol)}(-\bar{z}) = \sigma_3 M_1^{(sol)}(z)$ obtains

$$c_k^2 = -\bar{c}_k^1, \quad c_k^4 = -\bar{c}_k^3, \quad c_k^6 = \bar{c}_k^5, \quad c_k^8 = \bar{c}_k^7. \quad (4.72)$$

Thus, combining the relation (4.71) with (4.72) yields (4.68). Also the system (4.69) is obtained by substituting the expansion (4.70) into the residue condition (4.65a) at the discrete spectrums η_{j_k} . \square

Corollary 4.12. *Under the condition of no scattering, that is, $r(z) = 0$, the corresponding scattering matrix $S(z)$ is the identity matrix. Let $q_{sol}(x, t, \Lambda)$ denote the $N(\Lambda)$ -soliton solutions with the modified scattering data $\sigma_d^\Lambda = \{0, \{\eta_n, c_n T^2(\eta_n)\}_{n \in \Lambda}\}$. It follows from the reconstruction formula (2.43) for mCH equation that the solution $q_{sol}(x, t, \Lambda)$ is expressed by*

$$\begin{aligned} q_{sol}(x, t, \Lambda) &= -\partial_z M_{12}^{(sol)}(z)|_{z=i} M_{11}^{(sol)}(i) - \partial_z M_{21}^{(sol)}(z)|_{z=i} M_{11}^{(sol)}(i)^{-1}, \\ x(y, t) &= y + \ln M_{11}^{(sol)}(i). \end{aligned} \quad (4.73)$$

(I) For the case $\Lambda = \emptyset$, then

$$\begin{aligned} q_{sol}(x, t, \Lambda) &= -\partial_z M_{12}^{(sol)}(z)|_{z=i} M_{11}^{(sol)}(i) - \partial_z M_{21}^{(sol)}(z)|_{z=i} M_{11}^{(sol)}(i)^{-1} \\ &= i(1 - \hat{\alpha}_+/2), \end{aligned} \quad (4.74)$$

$$x(y, t, \sigma_d^\Lambda) = y + \ln \left[1 - \frac{i\hat{\alpha}_+}{2(i-1)} - \frac{i\hat{\alpha}_+}{2(i+1)} \right] \triangleq y + c_+. \quad (4.75)$$

(II) For the case $\Lambda = \emptyset$, then

$$\begin{aligned} q_{sol}(x, t, \Lambda) &= -\partial_z M_{12}^{(sol)}(z)|_{z=i} M_{11}^{(sol)}(i) - \partial_z M_{21}^{(sol)}(z)|_{z=i} M_{11}^{(sol)}(i)^{-1} \\ &= -\left(\frac{\hat{\alpha}_+}{2} - \sum_{k=1}^N \frac{\bar{\beta}_k}{(i - \bar{\eta}_{j_k})^2}\right) \left(1 - \frac{\hat{\alpha}_+}{4} + \sum_{k=1}^N \frac{\alpha_k}{(i - \eta_{j_k})}\right) \\ &\quad + \left(\frac{\hat{\alpha}_+}{2} - \sum_{k=1}^N \frac{\beta_k}{(i - \eta_{j_k})^2}\right) \left(1 - \frac{\hat{\alpha}_+}{4} + \sum_{k=1}^N \frac{\alpha_k}{(i - \eta_{j_k})}\right)^{-1} \end{aligned} \quad (4.76)$$

and

$$x(y, t, \sigma_d^\Lambda) = y + \ln \left[1 - \frac{\hat{\alpha}_+}{4} + \sum_{k=1}^N \frac{\alpha_k}{(i - \eta_{j_k})} \right] \triangleq y + c'_+. \quad (4.77)$$

4.4. The small-norm RH problem for error function. In (4.64), the jump condition $V^{(2)}(z)$ on path $\Sigma^{(2)}$ is ignored, and then error function $M^{(err)}(z)$ is generated. In this section, the attention is mainly focused on the problem of error function by a small-norm RH problem [29, 30, 44].

RH Problem 4.13. Find a matrix valued function $M^{(err)}(z)$ satisfies

- (1) The error function $M^{(err)}(z)$ is analytic in $\mathbb{C} \setminus \Sigma^{(2)}$.
- (2) Asymptotic behavior:

$$M^{(err)}(z) = I + \mathcal{O}(z^{-1}), \quad z \rightarrow \infty.$$

- (3) The jump condition:

$$M_+^{(err)}(z) = M_-^{(err)}(z)V^{(err)}(z), \quad (4.78)$$

where $V^{(err)}(z) = M^{(sol)}(z)V^{(2)}(z)M^{(sol)}(z)^{-1}$, and for $z \in \Sigma^{(2)}$ the error function $M^{(err)}(z)$ is of continuous boundary values $M_\pm^{(err)}(z)$.

The error function $M^{(err)}(z)$ has no poles based on the fact that $M^{(rhp)}(z)$ and $M^{(sol)}(z)$ have the same jump conditions and poles. Furthermore, the jump matrix $V^{(err)}(z)$ follows the same estimate as $V^{(2)}(z)$ from (4.62) for $1 \leq p \leq +\infty$

$$\begin{aligned} \left\| V^{(err)}(z) - I \right\|_{L^p(\Sigma^{(2)})} &= \left\| M^{(sol)}(z)V^{(2)}(z)M^{(sol)}(z)^{-1} - I \right\|_{L^p(\Sigma^{(2)})} \\ &\leq \left\| V^{(2)}(z) - I \right\|_{L^p(\Sigma^{(2)})} = O(e^{-2\varepsilon_0 t}), \end{aligned} \quad (4.79)$$

which indicates that the jump matrix $V^{(err)}(z)$ uniformly converges to the identity matrix. Then, it follows from the small norm theory of RH problem [29, 30, 44] that the solution of RH problem 4.13 can be uniquely expressed as

$$M^{(err)}(z) = I + \frac{1}{2\pi i} \int_{\Sigma^{(2)}} \frac{(I + \rho(s))(V^{(err)}(s) - I)}{s - z} ds, \quad (4.80)$$

where $\rho \in L^2(\Sigma^{(2)})$ is the unique solution of the operator equation

$$(1 - C_{V^{(err)}})\rho = C_{V^{(err)}}I, \quad (4.81)$$

where the operator $C_{V^{(err)}} : L^2(\Sigma^{(2)}) \rightarrow L^2(\Sigma^{(2)})$ denotes the Cauchy projection operator

$$C_{V^{(err)}}[f](z) = C_-[f(V^{(err)} - I)] = \lim_{k \rightarrow z} \int_{\Sigma^{(2)}} \frac{f(s)(V^{(err)}(s) - I)}{s - k} ds.$$

The definition of the limit C_- here is that the limit is obtained from the right side of the oriented contour $\Sigma^{(2)}$ with a non-tangent. The existence and uniqueness of the solution ρ of the equation (4.81) originates from the boundedness of Cauchy projection operator C_- , which immediately leads to

$$\|C_{V^{(err)}}\|_{L^2(\Sigma^{(2)}) \rightarrow L^2(\Sigma^{(2)})} = O(e^{-2\varepsilon_0 t}). \quad (4.82)$$

Furthermore,

$$\|\rho\|_{L^2(\Sigma^{(2)})} \lesssim \frac{\|C_{V^{(err)}}\|}{1 - \|C_{V^{(err)}}\|} \lesssim O(e^{-2\varepsilon_0 t}). \quad (4.83)$$

In conclusion, the existence, uniqueness and boundedness of the solution to RH problem 4.13 can be obtained. Further, in order to recover the solution $q(x, t)$ of mCH equation, we need to consider not only the asymptotic behavior at singular point $z = \infty$, but also the asymptotic behavior at singular point $z = i$ shown in Proposition 4.14.

Proposition 4.14. *As $z \rightarrow i$, the solution (4.80) to RH problem 4.13 is of the following expansion at $z = i$*

$$E(z) = E(i) + E_1(z - i) + O((z - i)^2), \quad (4.84)$$

where

$$E(i) = I + \frac{1}{2\pi i} \int_{\Sigma^{(2)}} \frac{(I + \rho(s))(V^{(err)} - I)}{s - i} ds, \quad (4.85)$$

$$E_1 = \frac{1}{2\pi i} \int_{\Sigma^{(2)}} \frac{(I + \rho(s))(V^{(err)} - I)}{(s - i)^2} ds. \quad (4.86)$$

The coefficients $E(i)$ and E_1 admit the following estimates

$$|E(i) - I| \lesssim O(e^{-2\varepsilon_0 t}), \quad |E_1| \lesssim O(e^{-2\varepsilon_0 t}). \quad (4.87)$$

Proof. By directly calculating the expansion of the solution at $z = i$, the equation (4.84) can be obtained. We now turn our attention to the estimation of coefficients $E(i)$ and E_1 . Combining the estimate (4.79) and (4.83) yields

$$|M^{(err)} - I| \leq |(1 - C_{V^{(err)}})(\rho)| + |C_{V^{(err)}}(\rho)| \lesssim O(e^{-2\varepsilon_0 t}). \quad (4.88)$$

Additionally, observing the fact $|s - i|^{-2}$ is bounded on the contour $\Sigma^{(2)}$, one then has

$$|E_1| \leq \|V^{(err)} - I\|_{L^1} + \|\rho\|_{L^2} \|V^{(err)} - I\|_{L^2} \lesssim O(e^{-2\varepsilon_0 t}), \quad (4.89)$$

which completes the proof of the proposition. \square

4.5. Analysis on pure $\bar{\partial}$ -problem. This section will study the pure $\bar{\partial}$ -problem 4.8 for $M^{(3)}(z)$ defined in (4.57). As [3, 19], the solution to $\bar{\partial}$ -problem 4.8 can be expressed by the integral equation

$$M^{(3)}(z) = I + \frac{1}{\pi} \iint_{\mathbb{C}} \frac{M^{(3)}(s)W^{(3)}(s)}{s-z} dA(s), \quad (4.90)$$

where $A(s)$ denotes the Lebesgue measure on the complex plane \mathbb{C} . With Cauchy-Green integral operator, the solution reduces to

$$M^{(3)}(z) = I \cdot (I - \mathbb{P}_z)^{-1}, \quad (4.91)$$

where

$$f\mathbb{P}_z(z) = \frac{1}{\pi} \iint_{\mathbb{C}} \frac{f(s)W^{(3)}(s)}{s-z} dA(s).$$

The following proposition shows that the operator \mathbb{P}_z is small-norm for a sufficiently large t , which means that the operator equation (4.91) is meaningful and $(1 - \mathbb{P}_z)^{-1}$ exists.

Proposition 4.15. *As $t \rightarrow \infty$, the Cauchy-Green integral operator \mathbb{P}_z satisfies the following inequality*

$$\|\mathbb{P}_z\|_{L^\infty \rightarrow L^\infty} \lesssim t^{-1/2}. \quad (4.92)$$

Proof. With the definition of Cauchy-Green integral operator \mathbb{P}_z

$$\|f\mathbb{P}_z\|_{L^\infty} \lesssim \|f\|_{L^\infty} \iint_{\mathbb{C}} \frac{|W^{(3)}(s)|}{|s-z|} dA(s), \quad (4.93)$$

where $f \in L^\infty$ and $W^{(3)}(z) = M^{(rhp)}(z)\bar{\partial}R^{(2)}(z)M^{(rhp)}(z)^{-1}$, which implies that we only need to estimate the second factor of the above equation. In what follows, we will prove the case $\xi > 2$ for $z \in \Omega_1$ in detail, and other areas can be similarly proved. Observing that $W^{(3)}(z) \equiv 0$ as $z \notin \bar{\Omega}$ and Proposition 4.9 indicates the solution $M^{(rhp)}(z)$ and $M^{(rhp)}(z)^{-1}$ are bounded for $z \in \bar{\Omega}$. Thus (4.93) is equivalent to

$$\iint_{\Omega_1} \frac{|W^{(3)}(s)|}{|s-z|} dA(s) \leq \iint_{\Omega_1} \frac{|\bar{\partial}R_1(s) \cdot e^{2it\theta}|}{|s-z|} dA(s). \quad (4.94)$$

It follows from Corollary 4.4 and the $\bar{\partial}$ -derivative (4.41) that the inequality (4.94) can be decompose into two integral equations

$$\iint_{\Omega_1} \frac{|\bar{\partial}R_1(s)|e^{-2t \operatorname{Im} \theta}}{|s-z|} dA(s) \lesssim J_1 + J_2, \quad (4.95)$$

where

$$J_1 = \iint_{\Omega_1} \frac{|r'_1(s)|e^{-2t \operatorname{Im} \theta}}{|s-z|} dA(s), \quad (4.96a)$$

$$J_2 = \iint_{\Omega_1} \frac{|s|^{-1/2}e^{-2t \operatorname{Im} \theta}}{|s-z|} dA(s). \quad (4.96b)$$

Let $z = \alpha + i\beta$ and $s = u + iv$. Observing that for $1 \leq q \leq +\infty$ with $\frac{1}{p} + \frac{1}{q} = 1$

$$\begin{aligned} \left\| \frac{1}{|s-z|} \right\| &= \left(\int_v^{+\infty} \left(\frac{1}{(u-\alpha)^2 + (v-\beta)^2} \right)^{q/2} \right)^{1/q} \\ &= \left(\int_v^{+\infty} \left(1 + \left(\frac{u-\alpha}{v-\beta} \right) \right)^{-q/2} d \left(\frac{u-\alpha}{v-\beta} \right) \cdot (v-\beta)^{-q+1} \right)^{-1/q} \\ &\lesssim |v-\beta|^{1/q-1}. \end{aligned} \quad (4.97)$$

On the other hand, for $z \in \Omega_1$ in the region $\xi > 2$, one has $e^{-2t \operatorname{Im} \theta} \leq e^{-\tau(\xi)v}$. Thus, applying Hölder inequality yields

$$\begin{aligned} J_1 &\leq \int_0^\infty \int_v^\infty \frac{|r_1'(s)| e^{-2t \operatorname{Im} \theta}}{|s-z|} dudv \\ &\leq \int_0^\infty \left\| \frac{1}{|s-z|} \right\|_{L^2(\mathbb{R}^+)} \left\| |r_1'(s)| \right\|_{L^2(\mathbb{R}^+)} e^{-\tau(\xi)v} dudv \\ &\leq \int_0^\infty |v-\beta|^{-1/2} e^{-\tau(\xi)v} dv \\ &= \int_0^\beta |v-\beta|^{-1/2} e^{-\tau(\xi)v} dv + \int_\beta^\infty |v-\beta|^{-1/2} e^{-\tau(\xi)v} dv \triangleq J_1^{(1)} + J_1^{(2)}. \end{aligned} \quad (4.98)$$

For $J_1^{(1)}$,

$$\begin{aligned} J_1^{(1)} &= \int_0^\beta \frac{1}{\sqrt{\beta-v}} e^{-\tau(\xi)v} dv = \int_0^1 \frac{\sqrt{\beta} e^{-t\tau(\xi)\beta\varpi}}{\sqrt{1-\varpi}} d\varpi \\ &\leq t^{-1/2} \int_0^1 \frac{1}{\sqrt{\varpi(1-\varpi)}} d\varpi \lesssim t^{-1/2}, \end{aligned}$$

where the variable $\varpi = v/\beta$. Similarly, we can proof $J_1^{(2)} \lesssim t^{-1/2}$, which completes the proof of (4.96a). Now let's turn our attention to the second integral equation (4.96b). Also, it's easy to check that for $1 \leq q \leq +\infty$ with $\frac{1}{p} + \frac{1}{q} = 1$

$$\left\| \frac{1}{|s|} \right\|_{L^p(v, +\infty)} = \left(\int_v^\infty \left(\frac{1}{\sqrt{u^2 + v^2}} \right)^p du \right)^{1/p} \lesssim v^{1/p-1}.$$

Then combined with Cauchy-Schwarz inequality, the following results are obtained

$$\begin{aligned}
J_2 &\leq \int_0^\infty \left\| \frac{1}{|s|} \right\|_{L^p(\mathbb{R}^+)} \left\| \frac{1}{|s-z|} \right\|_{L^q(\mathbb{R}^+)} e^{-\tau(\xi)v} dv \\
&\leq \int_0^\infty v^{1/p-1/2} |v-\beta|^{1/q-1} e^{-\tau(\xi)v} dv \\
&\leq \int_0^\beta v^{1/p-1/2} |v-\beta|^{1/q-1} e^{-\tau(\xi)v} dv + \int_\beta^\infty v^{1/p-1/2} |v-\beta|^{1/q-1} e^{-\tau(\xi)v} dv. \tag{4.99}
\end{aligned}$$

Similar to (4.98), one has $J_2 \lesssim t^{-1/2}$. To sum up, we have completed the proof of proposition 4.15. \square

As $z = i$, integral equation (4.90) becomes

$$M^{(3)}(i) = I + \frac{1}{\pi} \int \int_{\mathbb{C}} \frac{M^{(3)}(s)W^{(3)}(s)}{s-i} dA(s). \tag{4.100}$$

The asymptotic behavior of $M^{(3)}(z)$ at $z = i$ is required when constructing the solution of the mCH equation, which is reflected in the following proposition.

Proposition 4.16. *The integral equation (4.90) admits*

$$\left\| M^{(3)}(z) - I \right\| = \left\| \frac{1}{\pi} \int \int_{\mathbb{C}} \frac{M^{(3)}(s)W^{(3)}(s)}{s-i} dA(s) \right\| \lesssim O(t^{-1/2}). \tag{4.101}$$

As $z \rightarrow i$, $M^{(3)}(z)$ has the following expansion

$$M^{(3)}(z) = M^{(3)}(i) + M_1^{(3)}(x, t)(z-i) + O((z-i)^2), \tag{4.102}$$

where

$$M_1^{(3)}(x, t) = \frac{1}{\pi} \int \int_{\mathbb{C}} \frac{M^{(3)}(s)W^{(3)}(s)}{(s-i)^2} dA(s), \tag{4.103}$$

which such that as $t \rightarrow \infty$

$$\left| M_1^{(3)}(x, t) \right| \lesssim O(t^{-1/2}). \tag{4.104}$$

Proof. It is similar to the proof process of Proposition 4.15, and it follows from (4.91) and (4.15) that $\|M^{(3)}\|_{L^\infty} \lesssim 1$. Take the region $\xi \in (2, +\infty)$ as an example, the other situations are similar. Let $s = u + iv \in \Omega_1$, then

$$M^{(3)}(z)' = \frac{1}{\pi} \int \int_{\mathbb{C}} \frac{M^{(3)}(s)W^{(3)}(s)}{(s-i)^2} dA(s)$$

and

$$\begin{aligned}
\left\| M^{(3)}(z) - I \right\| &= \frac{1}{\pi} \left\| \frac{1}{\pi} \int \int_{\mathbb{C}} \frac{M^{(3)}(s)W^{(3)}(s)}{s-i} dA(s) \right\| \\
&\lesssim \int \int_{\mathbb{C}} \frac{|\bar{\partial}R_1(s)|e^{-\tau(\xi)tv}}{|s-i|} dudv \triangleq J_3 + J_4, \tag{4.105}
\end{aligned}$$

where

$$J_3 = \int \int_{\Omega_1} \frac{|r'_1(s)|e^{-\tau(\xi)tv}}{|s-i|} dudv, \quad (4.106a)$$

$$J_4 = \int \int_{\Omega_1} \frac{|s|^{-1}e^{-\tau(\xi)tv}}{|s-i|} dudv. \quad (4.106b)$$

Now turn our attention to proving J_3 . Observing that $r \in H^{1,1}(\mathbb{R})$, then $r' \in L^1(\mathbb{R})$. Applying Hölder inequality yields

$$\begin{aligned} J_3 &\leq \int_0^{+\infty} \int_v^{+\infty} \frac{|r'_1(s)|e^{-\tau(\xi)tv}}{|s-i|} dudv \\ &\leq \int_0^{+\infty} \sqrt{2} \|r'_1(s)\|_{L^1(\mathbb{R})} e^{-\tau(\xi)tv} dv \\ &\lesssim \int_0^{+\infty} e^{-\tau(\xi)tv} dv \lesssim O(t^{-1}). \end{aligned}$$

For J_4 , it follows from the fact $\| |s|^{-1} \|_{L^p(v,+\infty)} \lesssim v^{1/p-1}$ for $1 \leq p \leq +\infty$ with $\frac{1}{p} + \frac{1}{q} = 1$ and $\| |s-i|^{-1} \|_{L^q(v,+\infty)} \lesssim |v-1|^{1/q-1}$. Then

$$\begin{aligned} J_4 &= \int \int_{\Omega_1} \frac{|s|^{-1}e^{-\tau(\xi)tv}}{|s-i|} dudv \\ &\leq \int_0^{+\infty} e^{-\tau(\xi)tv} \| |s-i|^{-1} \|_{L^q} \| |s|^{-1} \|_{L^p} dv \\ &\lesssim \int_0^{+\infty} e^{-\tau(\xi)tv} |v-1|^{1/q-1} |v|^{1/p-1} dv \\ &= \int_0^1 e^{-\tau(\xi)tv} (1-v)^{1/q-1} v^{1/p-1} dv + \int_1^{+\infty} e^{-\tau(\xi)tv} (v-1)^{1/q-1} v^{1/p-1} dv \\ &\triangleq J_4^{(1)} + J_4^{(2)}. \end{aligned}$$

As in [3], one can obtain $J_4 \lesssim O(t^{-1/2})$. Similarly, inequality (4.104) can be proved by the same method. \square

5. DEFORMATION OF RH PROBLEM FOR $\xi \in (-1/4, 0)$ AND $\xi \in (0, 2)$

Starting from this section, we will analyze the long-time asymptotic behavior of solutions in region $\xi \in (-1/4, 0)$ and region $\xi \in (0, 2)$, corresponding to the existence of eight phase points $\{\xi_i\}_{i=1}^8$ and four phase points $\{\xi_i\}_{i=1}^4$ respectively, which is significantly different from that in regions $\xi \in (-\infty, -1/4)$ and $\xi \in (2, +\infty)$. In the analysis process, some matrix-valued functions here are equivalent to the matrix-valued functions in the above two areas, which will not be repeated, including the function $T(z) := T(z, \xi)$ defined in (4.4) and the matrix $M^{(1)}(z)$ defined by (4.21) satisfied RH problem 4.2. On the other hand, due to the existence of steady-state phase points, we need to partition the real axis \mathbb{R} . This is because in different intervals, the jump matrix has different

forms of triangular decomposition as in Section 3, which will affect the continuous extension of the next jump matrix. Thus, we define the intervals for $\xi \in (-1/4, 0)$ and $\xi \in (0, 2)$ as

$$I_{j1} = I_{j2} = \begin{cases} \left(\xi_j, \frac{\xi_j + \xi_{j-1}}{2} \right), & j = 1, 3, 5, 7, \\ \left(\frac{\xi_j + \xi_{j+1}}{2}, \xi_j \right), & j = 2, 4, 6, 8, \end{cases} \quad (5.1)$$

$$I_{j3} = I_{j4} = \begin{cases} \left(\frac{\xi_j + \xi_{j+1}}{2}, \xi_j \right), & j = 1, 3, 5, 7, \\ \left(\xi_j, \frac{\xi_j + \xi_{j-1}}{2} \right), & j = 2, 4, 6, 8. \end{cases} \quad (5.2)$$

and

$$I_{j1} = I_{j2} = \begin{cases} \left(\frac{\xi_j + \xi_{j+1}}{2}, \xi_j \right), & j = 1, 3, \\ \left(\xi_j, \frac{\xi_j + \xi_{j-1}}{2} \right), & j = 2, 4, \end{cases} \quad (5.3)$$

$$I_{j3} = I_{j4} = \begin{cases} \left(\xi_j, \frac{\xi_j + \xi_{j-1}}{2} \right), & j = 1, 3, \\ \left(\frac{\xi_j + \xi_{j+1}}{2}, \xi_j \right), & j = 2, 4, \end{cases} \quad (5.4)$$

shown in Fig. 4.

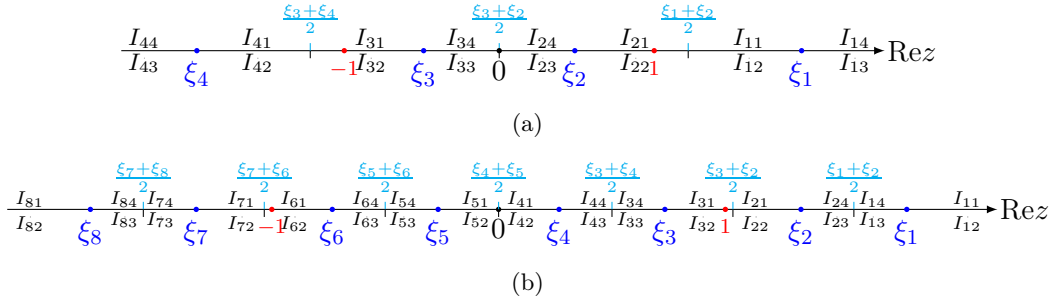

FIGURE 4. (a) corresponds to the region $0 \leq \xi < 2$. (b) corresponds to the $-\frac{1}{4} < \xi < 0$.

5.1. Contour deformation. In order to get a new RH problem, which has no jump on the real axis \mathbb{R} , the function $M^{(1)}(z)$ needs to be continuously extended. In essence, the oscillatory functions $e^{\pm 2it\theta}$ in the jump matrix is treated according to its attenuation property. Before that, some contours need to be introduced to better describe the deformation of the jump matrix.

For $\ell \in \left(0, \frac{|\xi_j + (-1)^j - \xi_j|}{2 \cos \phi}\right)$ with $\xi \in (-1/4, 0)$, define

$$\Sigma_{jk} = \begin{cases} \xi_j + e^{i((k/2+1/2+j)\pi + (-1)^{j+1}\phi)} \ell, & k = 1, 3, \\ \xi_j + e^{i((k/2+j)\pi + (-1)^j \phi)} \ell, & k = 2, 4. \end{cases}$$

For $\xi \in (0, 2)$, define

$$\Sigma_{jk} = \begin{cases} \xi_j + e^{i((k/2+j)\pi + (-1)^j \phi)} \ell, & k = 1, 3, \\ \xi_j + e^{i((k/2+1/2+j)\pi + (-1)^{j+1}\phi)} \ell, & k = 2, 4. \end{cases}$$

As $j = 1, 8$ with $\xi \in (-1/4, 0)$

$$\begin{cases} \Sigma_{j1}(\xi) = \xi_j + e^{(1+j)\pi i + (-1)^{j+1}i\phi} \mathbb{R}^+, \\ \Sigma_{j2}(\xi) = \xi_j + e^{(1+j)\pi i + (-1)^j i\phi} \mathbb{R}^+, \\ \Sigma_{j3}(\xi) = \xi_j + e^{j\pi i + (-1)^{j+1}i\phi} \mathbb{R}^+, \\ \Sigma_{j4}(\xi) = \xi_j + e^{j\pi i + (-1)^j i\phi} \mathbb{R}^+, \\ \Sigma_p^\pm = \frac{\xi_{p+1} + \xi}{2} + e^{i\pi} \ell, \quad p = 1, 2, \dots, 7. \end{cases}$$

As $j = 1, 4$ with $\xi \in (0, 2)$

$$\begin{cases} \Sigma_{j1}(\xi) = \xi_j + e^{j\pi i + (-1)^j i\phi} \mathbb{R}^+, \\ \Sigma_{j2}(\xi) = \xi_j + e^{j\pi i + (-1)^{j+1}i\phi} \mathbb{R}^+, \\ \Sigma_{j3}(\xi) = \xi_j + e^{(1+j)\pi i + (-1)^j i\phi} \mathbb{R}^+, \\ \Sigma_{j4}(\xi) = \xi_j + e^{(1+j)\pi i + (-1)^{j+1}i\phi} \mathbb{R}^+, \\ \Sigma_p^\pm = \frac{\xi_{p+1} + \xi}{2} + e^{i\pi} \ell, \quad p = 2, 3, 4. \end{cases}$$

Applying the above contours defines the following regions and new contours

$$\Omega(\xi) = \bigcup_{\substack{k=1, \dots, 4, \\ j=1, \dots, n(\xi)}} \Omega_{jk}, \quad \Omega_\pm(\xi) = \mathbb{C} \setminus \Omega, \quad (5.5)$$

$$\Sigma^\sharp(\xi) = \left(\bigcup_{\substack{k=1, \dots, 4, \\ j=1, \dots, n(\xi)}} \Sigma_{jk} \right) \cup \left(\bigcup_{j=1, \dots, n(\xi)} \Sigma_j^\pm \right), \quad (5.6)$$

$$\Sigma^{(2)}(\xi) = \Sigma^\sharp(\xi) \bigcup_{n \in N \setminus \Lambda} (\partial \bar{\mathbb{P}}_n \cup \partial \mathbb{P}_n). \quad (5.7)$$

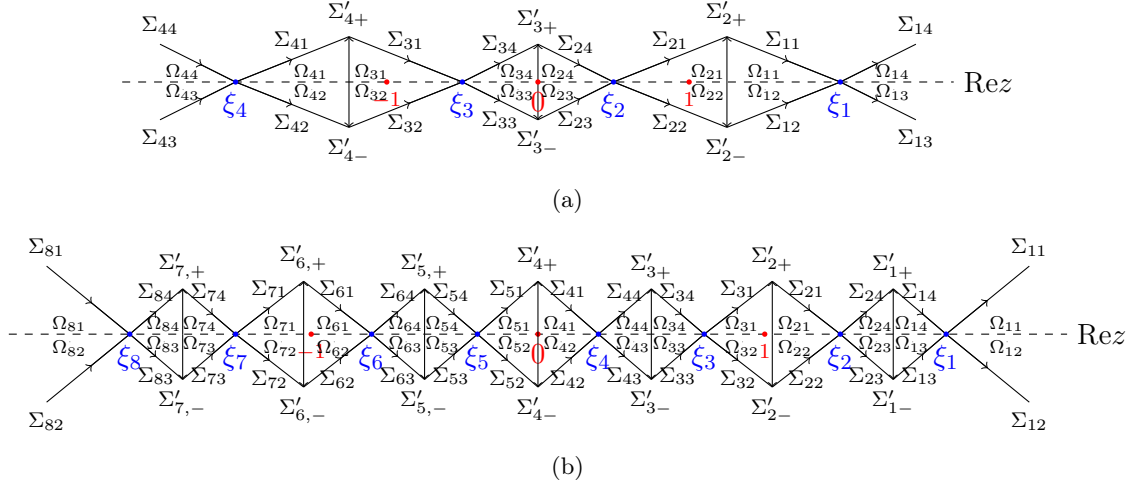

FIGURE 5. Figure (a) and (b) are corresponding to the $0 < \xi < 2$ and $-\frac{1}{4} < \xi < 0$ respectively. The regions Ω_{ij} are of the boundaries Σ_{ij} .

Additionally, taking $\Sigma_8^\pm = \emptyset$ for $\xi(-1/4, 0)$ and $\Sigma_1^\pm = \emptyset$ for $\xi(0, 2)$. Fix a sufficiently small constant angle ϕ such that the following conditions hold

- (1) Each Ω_j are disjoint with \mathbb{P}_N , $\overline{\mathbb{P}}_N$ and $\{z \in \mathbb{C} \mid \text{Im } \theta(z) = 0\}$.
- (2) $2 \tan \phi > \xi_n(\xi)/2 - \xi_n(\xi)/2+1$.

Since for each regions Ω_j , the oscillation terms $e^{\pm 2it\theta}$ have different attenuation properties, which will affect the contour deformation, so we first give the following proposition.

Proposition 5.1. *For $\xi \in (-1/4, 0)$ and $\xi \in (0, 2)$, there exists a constant $\tau(\xi)$ such that*

$$\text{Im } \theta \leq -\tau(\xi) \text{Im } z \cdot \frac{|z|^2 - \xi_j^2}{4 + |z|^2}, \quad z \in \Omega_{j1}, \Omega_{j3}, \quad (5.8)$$

$$\text{Im } \theta \geq \tau(\xi) \text{Im } z \cdot \frac{|z|^2 - \xi_j^2}{4 + |z|^2}, \quad z \in \Omega_{j2}, \Omega_{j4}. \quad (5.9)$$

Proof. The proof of this proposition is similar to [69]. \square

In what follows, we perform contour deformation for RH problem 4.2, following the standard procedure in [27] and [3] in the presence of discrete spectrum. Now we introduce a new matrix-valued function $M^{(2)}(z) = M^{(2)}(y, t, z)$ defined by

$$M^{(2)}(z) = M^{(1)}(z)\mathcal{R}^{(2)}(z), \quad (5.10)$$

where the choice of $\mathcal{R}^{(2)}(z)$ needs to meet the following conditions

- (1) To remove jump condition for $M^{(1)}(z)$ on real axis \mathbb{R} .
- (2) Does not affect the residue condition at the poles η_n and $\bar{\eta}_n$ for $n \in \Lambda$.

- (3) The new jump matrix for $M^{(2)}(z)$ along path $\Sigma^{(2)}$ is exponentially decaying.
(4) $\mathcal{R}_-^{(2)}(z)^{-1}V^{(1)}(z)\mathcal{R}_+^{(2)}(z) \equiv I$.

Simple calculations show that

$$\begin{aligned} M_+^{(2)}(z) &= M_+^{(1)}(z)\mathcal{R}_+^{(2)}(z) = M_-^{(1)}(z)V^{(1)}(z) \\ &= M_-^{(2)}(z)\mathcal{R}_-^{(2)}(z)^{-1}V^{(1)}(z)\mathcal{R}_+^{(2)}(z), \end{aligned}$$

where $\mathcal{R}_\pm^{(2)}(z)$ are the boundaries of $\mathcal{R}^{(2)}(z)$ as $\text{Im}(z) \rightarrow 0$. To this end, for $k = 1, 2, \dots, n(\xi)$, we define

$$\mathcal{R}^{(2)}(z) = \begin{cases} \begin{pmatrix} 1 & R_{kj}(z)e^{-2it\theta} \\ 0 & 1 \end{pmatrix}, & z \in \Omega_{kj}, \quad j = 1, 3, \\ \begin{pmatrix} 1 & 0 \\ R_{kj}(z)e^{2it\theta} & 1 \end{pmatrix}, & z \in \Omega_{kj}, \quad j = 2, 4, \\ I, & z \in \text{elsewhere}, \end{cases} \quad (5.11)$$

where the functions $R_{kj}(z)$ are defined in Proposition 5.2.

Proposition 5.2. *For $\xi \in (-1/4, 0)$ and $\xi \in (0, 2)$, the function $R_{kj}(z) : \overline{\Omega}_{kj} \rightarrow \mathbb{C}$, $j = 1, 2, 3, 4$ and $k = 1, 2, \dots, n(\xi)$ are of the boundary values*

$$R_{k1}(z, \xi) = \begin{cases} p_{k1}(z, \xi)T_+(z)^2, & z \in I_{k1}, \\ p_{k1}(\xi_k, \xi)T_k(\xi)^2(z - \xi_k)^{2i\nu(\xi_k)}, & z \in \Sigma_{k1}, \end{cases} \quad (5.12a)$$

$$R_{k2}(z, \xi) = \begin{cases} p_{k2}(z, \xi)T_-(z)^{-2}, & z \in I_{k2}, \\ p_{k2}(\xi_k, \xi)T_k(\xi)^{-2}(z - \xi_k)^{-2i\nu(\xi_k)}, & z \in \Sigma_{k2}, \end{cases} \quad (5.12b)$$

$$R_{k3}(z, \xi) = \begin{cases} p_{k3}(z, \xi)T(z)^2, & z \in I_{k3}, \\ p_{k3}(\xi_k, \xi)T_k(\xi)^2(z - \xi_k)^{2i\nu(\xi_k)}, & z \in \Sigma_{k3}, \end{cases} \quad (5.12c)$$

$$R_{k4}(z, \xi) = \begin{cases} p_{k4}(z, \xi)T(z)^{-2}, & z \in I_{k4}, \\ p_{k4}(\xi_k, \xi)T_k(\xi)^{-2}(z - \xi_k)^{-2i\nu(\xi_k)}, & z \in \Sigma_{k4}, \end{cases} \quad (5.12d)$$

where the entries p_{kj} appearing in (5.12) are defined by

$$p_{k1}(z, \xi) = -\frac{r(z)}{1 - |r(z)|^2}, \quad p_{k3}(z, \xi) = r(z), \quad (5.13)$$

$$p_{k2}(z, \xi) = -\frac{\bar{r}(z)}{1 - |r(z)|^2}, \quad p_{k4}(z, \xi) = \bar{r}(z). \quad (5.14)$$

The function $R_{kj}(z)$ has the following estimates

$$|R_{kj}(z)| \lesssim \sin^2(z_0 \arg(z - \xi_k)) + (1 + \text{Re } z)^{-1/2}, \quad z \in \Omega_{kj}, \quad (5.15)$$

$$|\bar{\partial}R_{kj}(z)| \lesssim |p'_{kj}(\text{Re } z)| + |z - \xi_k|^{-1/2}, \quad z \in \Omega_{kj}, \quad (5.16)$$

$$\bar{\partial}R_{kj}(z) \equiv 0, \quad z \in \text{elsewhere}. \quad (5.17)$$

Based on the above analysis, our new matrix $M^{(2)}(z)$ satisfies the following mixed RH problem.

RH Problem 5.3. Find a matrix-valued function $M^{(2)}(z)$ defined by (5.10) such that

- (i) The function $M^{(2)}(z)$ is continuous in \mathbb{C} with continuous first partial derivatives in $\mathbb{C} \setminus (\Sigma^{(2)} \cup \{\eta_n, \bar{\eta}_n\}_{n \in \Lambda})$.
- (ii) The jump relation

$$M_+^{(2)}(z) = M_-^{(2)}(z)V^{(2)}(z), \quad z \in \Sigma^{(2)}, \quad (5.18)$$

where the jump matrix is defined by

$$V^{(2)}(z) = \begin{cases} R^{(2)}(z)^{-1}|_{\Omega_{k1} \cup \Omega_{k4}}, & z \in \Sigma_{k1} \cup \Sigma_{k4}, \\ R^{(2)}(z)|_{\Omega_{k2} \cup \Omega_{k3}}, & z \in \Sigma_{k2} \cup \Sigma_{k3}, \\ R^{(2)}(z)^{-1}|_{\Omega_{(k-1) \ (3\mp 1)/2}} R^{(2)}(z)|_{\Omega_{k \ (3\mp 1)/2}}, & z \in \Sigma_k^\pm, \ k \text{ is even}, \\ R^{(2)}(z)^{-1}|_{\Omega_{k \ (7\pm 1)/2}} R^{(2)}(z)|_{\Omega_{(k+1) \ (7\pm 1)/2}}, & z \in \Sigma_k^\pm, \ k \text{ is odd}, \\ \begin{pmatrix} 1 & 0 \\ -C_n(z - \eta_n)^{-1}T(z)^{-2}e^{2it\theta_n} & 1 \end{pmatrix}, & z \in \partial\mathbb{P}_n, \ n \in \nabla, \\ \begin{pmatrix} 1 & -C_n^{-1}(z - \eta_n)T^2(z)e^{-2it\theta_n} \\ 0 & 1 \end{pmatrix}, & z \in \partial\mathbb{P}_n, \ n \in \Delta, \\ \begin{pmatrix} 1 & \bar{C}_n(z - \bar{\eta}_n)^{-1}T^2(z)e^{-2it\bar{\theta}_n} \\ 0 & 1 \end{pmatrix}, & z \in \partial\bar{\mathbb{P}}_n, \ n \in \nabla, \\ \begin{pmatrix} 1 & 0 \\ \bar{C}_n^{-1}(z - \bar{\eta}_n)e^{2it\bar{\theta}_n}T(z)^{-2} & 1 \end{pmatrix}, & z \in \partial\bar{\mathbb{P}}_n, \ n \in \Delta. \end{cases} \quad (5.19)$$

(iii) Asymptotic behavior:

$$M^{(2)}(z) = I + O(z^{-1}), \quad z \rightarrow \infty \quad (\text{and } z \rightarrow 0 \text{ by symmetry}), \quad (5.20)$$

$$M^{(2)}(z) = \left(\text{diag}(a_1(y, t), a_1^{-1}(y, t)) + \begin{pmatrix} 0 & a_2(y, t) \\ a_3(y, t) & 0 \end{pmatrix} (z - i) \right) T(i)^{\sigma_3} (I - T_0(\xi)(z - i)) + O((z - i)^2), \quad (5.21)$$

where $a_j(y, t)$, $j = 1, 2, 3$ are real-valued functions from the expansion of $M^{(2)}(z)$ at $z = i$.

(iv) Residue conditions: The matrix $M^{(2)}(z)$ has simple poles at η_n and $\bar{\eta}_n$ with

$$\text{Res}_{\eta_n} M^{(2)}(z) = \lim_{z \rightarrow \eta_n} M^{(2)}(z) \begin{pmatrix} 0 & 0 \\ c_n T^2(z) e^{2it\theta(\eta_n)} & 0 \end{pmatrix}, \quad (5.22a)$$

$$\text{Res}_{\bar{\eta}_n} M^{(2)}(z) = \lim_{z \rightarrow \bar{\eta}_n} M^{(2)}(z) \begin{pmatrix} 0 & \bar{c}_n T^{-2}(z) e^{-2it\bar{\theta}(\eta_n)} \\ 0 & 0 \end{pmatrix}. \quad (5.22b)$$

(v) The $\bar{\partial}$ -derivative: for $z \in \mathbb{C}$, one has

$$\bar{\partial}M^{(2)}(z) = M^{(2)}(z)W(z), \quad (5.23)$$

where

$$W(z) = \begin{cases} \begin{pmatrix} 0 & \bar{\partial}R_{kj}(z, \xi)e^{-2it\theta} \\ 0 & 0 \end{pmatrix}, & z \in \Omega_{kj}, j = 1, 3, \\ \begin{pmatrix} 0 & 0 \\ \bar{\partial}R_{kj}(z, \xi)e^{2it\theta} & 0 \end{pmatrix}, & z \in \Omega_{kj}, j = 2, 4, \\ \mathbf{0}, & z \in \text{elsewhere.} \end{cases} \quad (5.24)$$

5.2. Decomposition of the mixed RH problem. To solve the mixed RH problem 5.3 for $M^{(2)}(z)$, the mixed RH problem is decomposed into pure RH problem for $M_{rhp}^{(2)}(z)$ corresponding to $W(z) \equiv 0$ and pure $\bar{\partial}$ -problem for $M^{(3)}(z)$ corresponding to $W(z) \neq 0$.

RH Problem 5.4. Find a matrix function $M_{rhp}^{(2)}(z)$ with the same asymptotic and symmetric properties as $M^{(2)}(z)$ to satisfy

- (1) $M_{rhp}^{(2)}(z)$ is analytic in $\mathbb{C} \setminus \Sigma^{(2)}$.
- (2) Jump condition:

$$M_{rhp,+}^{(2)}(z) = M_{rhp,-}^{(2)}(z)V^{(2)}(z), \quad (5.25)$$

where $V^{(2)}(z)$ is defined by (5.19).

- (3) The $\bar{\partial}$ -derivative: for $z \in \mathbb{C}$, $W(z) = 0$.
- (4) Residue conditions: The matrix $M_{rhp}^{(2)}(z)$ has simple poles at η_n and $\bar{\eta}_n$ with

$$\text{Res}_{\eta_n} M_{rhp}^{(2)}(z) = \lim_{z \rightarrow \eta_n} M_{rhp}^{(2)}(z) \begin{pmatrix} 0 & 0 \\ c_n T^2(z) e^{2it\theta(\eta_n)} & 0 \end{pmatrix}, \quad (5.26a)$$

$$\text{Res}_{\bar{\eta}_n} M_{rhp}^{(2)}(z) = \lim_{z \rightarrow \bar{\eta}_n} M_{rhp}^{(2)}(z) \begin{pmatrix} 0 & \bar{c}_n T^{-2}(z) e^{-2it\bar{\theta}(\eta_n)} \\ 0 & 0 \end{pmatrix}. \quad (5.26b)$$

Due to the existence of steady-state phase points ξ_j ($j = 1, 2, \dots, n(\xi)$), and the jump matrix $V^{(2)}$ does not uniformly converge to the identity matrix in the small neighborhood of phase points ξ_j , a small neighborhood $U(\xi)$ is introduced in each phase point

$$U(\xi) = \bigcup_{j=1,2,\dots,n(\xi)} U_{\xi_j}, \quad U_{\xi_j} = \{z : |z - \xi_j| \leq \min\{\rho, \frac{1}{3} \min_{m \neq n} |\eta_m - \eta_n|\}\}. \quad (5.27)$$

In what follows, we investigate the estimate for $V^{(2)}$.

Proposition 5.5. For $1 \leq p \leq +\infty$, the jump matrix $V^{(2)}$ such that

$$\left\| V^{(2)} - I \right\|_{L^p(\Sigma_{jk} \setminus U_{\xi_j})} = O(e^{-ct}), \quad t \rightarrow \infty, \quad (5.28)$$

$$\left\| V^{(2)} - I \right\|_{L^p(\Sigma_j^\pm)} = O(e^{-c't}), \quad t \rightarrow \infty, \quad (5.29)$$

where c (c') are positive constants, $j = 1, 2, \dots, n(\xi)$ and $k = 1, 2, 3, 4$.

Proof. Taking $\xi \in (-1/4, 0)$ as example, other situations are similar and can be proved. Let $z - \xi = \ell e^{i\psi}$ with $\ell \in (\rho, \infty)$ for $\Sigma_{11} \setminus U_{\xi_1}$

$$\begin{aligned} \left\| V^{(2)} - I \right\|_{L^p(\Sigma_{11} \setminus U_{\xi_1})}^p &= \left\| p_{11}(\xi_1) T_1(\xi)^2 (z - \xi_1)^{2iv(\xi_1)} e^{-2it\theta} \right\|_{L^p(\Sigma_{11} \setminus U_{\xi_1})}^p \\ &\lesssim \int_{\Sigma_{11} \setminus U_{\xi_1}} e^{-p\tau(\xi)t \operatorname{Im} z \frac{|z|^2 - \xi_1^2}{4 + |z|^2}} dz \\ &\lesssim \int_{\rho}^{+\infty} e^{-p\tau(\xi)t\ell} d\ell \lesssim t^{-1} \exp(-p\tau(\xi)t\rho). \end{aligned} \quad (5.30)$$

Using the same idea, inequality (5.29) can be proved, which completes the proof of the proposition. \square

Proposition 5.5 shows that the jump matrix $V^{(2)}(z)$ uniformly converges to the identity matrix on $\Sigma^\sharp \setminus U(\xi)$, which encourages us to ignore the jump of $M_{rhp}^{(2)}(z)$ out $U(\xi)$, and then we can do the following decomposition

$$M_{rhp}^{(2)}(z) = \begin{cases} E(z, \xi) M^{(sol)}(z), & z \notin U(\xi), \\ E(z, \xi) M^{(sol)}(z) M^{(mod)}(z), & z \in U(\xi). \end{cases} \quad (5.31)$$

It follows from (5.31) that $M_{rhp}^{(2)}(z)$ is decomposed into two parts, one is $M^{(sol)}(z)$ corresponding to the pure RH problem and ignoring the jump condition out $U(\xi)$, the other is the local model $M^{(mod)}(z)$ on the small neighborhood of the steady-state phase points ξ_j , which can be matched by using the parabolic cylinder model, where $E(z, \xi)$ is the error function, which is analyzed by the small-norm RH problem [25, 44].

5.3. Analysis on pure RH problem. At the beginning of this section, we will analyze the construction of the solution of the pure RH problem on region $\xi \in (-1/4, 0) \cup (0, 2)$. From (5.31), it is clear that this includes two parts, one is the soliton solution provided by the discrete spectrum outside the small neighborhood of the phase point, and the other is the solution provided by the phase points ξ_j inside the small neighborhood. To this end, first define some new contours

$$\Sigma^{(h)} = \left(\bigcup_{\substack{k=1, \dots, 4, \\ j=1, \dots, n(\xi)}} \Sigma_{jk} \right) \cap U(\xi),$$

which is shown in Fig. 6.

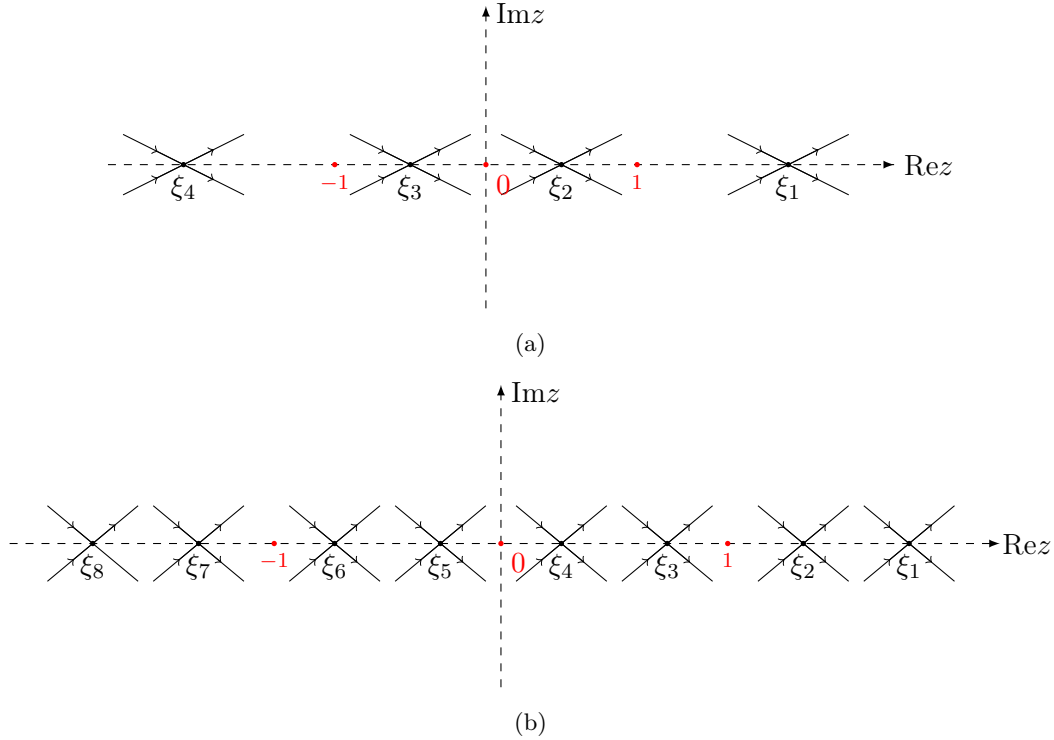

FIGURE 6. Figures (a) and (b) denote the contour $\Sigma^{(\natural)}$ corresponding to the $0 < \xi < 2$ and $-\frac{1}{4} < \xi < 0$, respectively.

5.3.1. *The outer model: an N -soliton potential.* In this section, similar to region $\xi \in (-\infty, -1/4) \cup (2, +\infty)$, the external soliton solution is constructed from the original RH problem 2.6. The difference is that there are phase points ξ_j at this time, which means that the combination of $U(\xi)$ is not empty.

Proposition 5.6. *The matrix $M^{(sol)}(z)$ solves RH problem 4.7 for $M^{(rhp)}(z)$ and satisfies Proposition 4.9.*

5.3.2. *Local model near the saddle points ξ_j .* This section will consider the local RH problem in the small neighborhood of the steady-state phase points ξ_j , based on the parabolic cylindrical function.

RH Problem 5.7. *Find a matrix-valued function $M^{(mod)}(z)$ such that*

- (1) $M^{(mod)}(z)$ is analytic in $\mathbb{C} \setminus \Sigma^{(\natural)}$.
- (2) For $z \in \Sigma^{(\natural)}$, $M^{(mod)}(z)$ has continuous boundary values $M_{\pm}^{(mod)}(z)$ with jump condition

$$M_{+}^{(mod)}(z) = M_{-}^{(mod)}(z)V^{(2)}(z). \quad (5.32)$$

(3) *Asymptotic behavior:*

$$M^{(mod)}(z) = I + \mathcal{O}(z^{-1}), \quad z \rightarrow \infty.$$

The solution of this RH problem 5.7 depends on the Beal-Coifman operator theory [2]. Now we construct the relationship between $M^{(mod)}(z)$ and $M^{(mod),\xi_k}(z)$, where $k = 1, 2, \dots, n(\xi)$. Observing that RH problem 5.7 only has jump condition and no poles. The jump condition $V^{(2)}(z)$ adopts trivial decomposition based on Beal-Coifman operator theory

$$V^{(2)}(z) = (I - \omega_{kj}^-)^{-1}(I + \omega_{kj}^+),$$

where $\omega_{kj}^- = I - V^{(2)}(z)^{-1} = V^{(2)}(z) - I$ and $\omega_{kj}^+ = 0$ with

$$\omega_{kj}^-(z) = \begin{cases} \begin{pmatrix} 0 & R_{kj}(z, \xi)e^{-2it\theta} \\ 0 & 0 \end{pmatrix}, & z \in \Sigma_{kj}, \quad j = 1, 3, \\ \begin{pmatrix} 0 & 0 \\ R_{kj}(z, \xi)e^{2it\theta} & 0 \end{pmatrix}, & z \in \Sigma_{kj}, \quad j = 2, 4. \end{cases}$$

Applying the Cauchy projection operators C_{\pm} on $\Sigma_{kj}^{(\natural)}$ yields for any $f \in L^2(\Sigma_{jk}^{(\natural)})$

$$C_{\pm}f(z) = \lim_{s \rightarrow z \in \Sigma_{jk}^{(\natural)}} \frac{1}{2\pi i} \int_{\Sigma_{jk}^{(\natural)}} \frac{f(s)}{s - z} ds, \quad (5.33)$$

where $k = 1, 2, \dots, n(\xi)$. Furthermore, we define the Beals-Coifman operator as

$$C_{w_{jk}}(f) = C_-(fw_{jk}^+) + C_+(fw_{jk}^-). \quad (5.34)$$

we define

$$\begin{aligned} \Sigma_k^{(\natural)} &= \bigcup_{j=1,2,3,4} \Sigma_{kj}^{(\natural)}, \quad w_k = \sum_{j=1}^4 w_{kj}, \\ \omega &= \sum_{k=1}^{n(\xi)} w_k, \quad \Sigma^{(\natural)} = \bigcup_{k=1,2,\dots,n(\xi)} \Sigma_k^{(\natural)}, \end{aligned}$$

and then we have $C_{\omega} = \sum_{k=1}^{n(\xi)} C_{w_k}$. The existence and uniqueness of the solution of RH problem 5.7 can be guaranteed by the following lemma corresponding to Proposition 2.11 in Deift and Zhou [30].

Lemma 5.8. *Let $f \in I + L^2(\Sigma)$ be the solution of the singular integral equation*

$$f = I + C_{\omega}(f). \quad (5.35)$$

Then, the unique solution to RH problem 5.7 for $M^{(mod)}(z)$ has the form

$$M^{(mod)}(z) = I + \frac{1}{2\pi i} \int_{\Sigma^{(\natural)}} \frac{f(s)w(s)}{s - z} ds. \quad (5.36)$$

Simple calculations show that $\|\omega_{kj}^{-1}\|_{L^2(\Sigma_{kj}^{\natural})} = O(t^{-1/2})$, which implies $1 - C_\omega$, and $1 - C_{\omega_k}$, and $1 - C_{\omega_{kj}}$ exist and are reversible as $t \rightarrow +\infty$. Thus, combining with Lemma 5.8, the solution to RH problem 5.7 is expressed by

$$M^{(mod)}(z) = I + \frac{1}{2\pi i} \int_{\Sigma^{\natural}} \frac{(I - C_\omega)^{-1} I w(s)}{s - z} ds. \quad (5.37)$$

In what follows, following the strategy of Deift-Zhou [27], the contribution to the solution is calculated at each phase point. First, the following equation is introduced in Proposition 5.9.

Proposition 5.9. *As $t \rightarrow +\infty$, the integral equation can be decomposed into the sum of the integral equation at phase points ξ_k*

$$\frac{1}{2\pi i} \int_{\Sigma^{\natural}} \frac{(I - C_\omega)^{-1} I w(s)}{s - z} ds = \frac{1}{2\pi i} \sum_{k=1}^{n(\xi)} \int_{\Sigma_k^{\natural}} \frac{(I - C_{\omega_k})^{-1} I w_k(s)}{s - z} ds + \mathcal{O}(t^{-1}). \quad (5.38)$$

Proof. Following the decomposition [64]

$$\begin{aligned} 1 - \sum_{j \neq k}^{n(\xi)} C_{\omega_j} C_{\omega_k} (1 - C_{\omega_k})^{-1} &= (1 - C_\omega) \left(1 + \sum_{j=1}^{n(\xi)} C_{\omega_j} (1 - C_{\omega_j})^{-1} \right), \\ 1 - \sum_{j \neq k}^{n(\xi)} (1 - C_{\omega_k})^{-1} C_{\omega_j} C_{\omega_k} &= \left(1 + \sum_{j=1}^{n(\xi)} C_{\omega_j} (1 - C_{\omega_j})^{-1} \right) (1 - C_\omega), \end{aligned}$$

we observe that it is necessary to estimate the norm of $C_{\omega_j} C_{\omega_k}$ from L^∞ to L^2 and L^2 to L^2 . Combining the result $\|\omega_{kj}^{-1}\|_{L^2(\Sigma_{kj}^{\natural})} = O(t^{-1/2})$ with Lemma 3.5 in Deift-Zhou [27] yields

$$\|C_{\omega_j} C_{\omega_k}\|_{L^2(\Sigma^{\natural})} = \mathcal{O}(t^{-1/2}), \quad \|C_{\omega_j} C_{\omega_k}\|_{L^\infty(\Sigma^{\natural}) \rightarrow L^2(\Sigma^{\natural})} = \mathcal{O}(t^{-3/4}). \quad (5.39)$$

Additionally, the following equality holds

$$\begin{aligned} (1 - C_\omega)^{-1} I &= I + \sum_{j=1}^{n(\xi)} C_{\omega_j} (1 - C_\omega)^{-1} I + \left[1 + \sum_{j=1}^{n(\xi)} C_{\omega_j} (1 - C_\omega)^{-1} \right] \\ &\quad \times \left[1 - \sum_{j \neq k}^{n(\xi)} C_{\omega_j} C_{\omega_k} ((1 - C_\omega)^{-1}) \right]^{-1} \left(\sum_{j \neq k}^{n(\xi)} C_{\omega_j} C_{\omega_k} (1 - C_\omega)^{-1} \right) I \\ &\triangleq I + \sum_{j=1}^{n(\xi)} C_{\omega_j} (1 - C_\omega)^{-1} I + J_1 J_2 J_3 I, \end{aligned}$$

where

$$\begin{aligned} J_1 &= 1 + \sum_{j=1}^{n(\xi)} C_{\omega_j} (1 - C_{\omega_j})^{-1}, \\ J_2 &= \left[1 - \sum_{j \neq k} C_{\omega_j} C_{\omega_k} ((1 - C_{\omega_j})^{-1}) \right]^{-1}, \\ J_3 &= \sum_{j \neq k} C_{\omega_j} C_{\omega_k} (1 - C_{\omega_j})^{-1}. \end{aligned}$$

It follows from Cauchy-Schwartz inequality that

$$\begin{aligned} \left| \int_{\Sigma^{(h)}} J_1 J_2 J_3 I w \right| &\leq \|J_1\|_{L^2(\Sigma_j^{(h)})} \|J_2\|_{L^2(\Sigma_j^{(h)})} \|J_3\|_{L^\infty(\Sigma_j^{(h)}) \rightarrow L^2(\Sigma_j^{(h)})} \|w\|_{L^2(\Sigma_j^{(h)})} \\ &\lesssim t^{-3/4} t^{-1/4} = O(t^{-1}). \end{aligned} \quad (5.40)$$

□

It follows from Proposition 5.9 that RH problem 5.7 can be reduced to a model RH problem solved by parabolic cylinder functions at each points ξ_j . For the points ξ_j , the phase function $\theta(z)$ can be expressed by

$$\theta(z) = \theta(\xi_j) + \frac{\theta''(\xi_j)}{2} (z - \xi_j)^2 + O(|z - \xi_j|^3), \quad z \rightarrow \xi_j. \quad (5.41)$$

As in Section 8.2 [32] and Lemma 3.35 [23], the higher-order expansion term of the phase function $\theta(z)$ decays rapidly. Now considering the local RH problem for $M^{(mod),j}(z)$ at ξ_j , $j = 1, 2, \dots, n(\xi)$.

RH Problem 5.10. Find a 2×2 matrix-valued function $M^{(mod),j}(z)$ such that

(I) $M^{(mod),j}(z)$ is analytic in $\mathbb{C} \setminus \Sigma_j^{mod}$.

(II) Jump condition:

$$M_+^{(mod),j}(z) = M_-^{(mod),j}(z) V^{(mod),j}(z), \quad z \in \Sigma_j^{mod}, \quad (5.42)$$

where

$$V^{(mod),j}(z) = \begin{cases} \begin{pmatrix} 1 & \frac{r(\xi_j)}{1-|r(\xi_j)|^2} T_j(\xi_j)^2 (z - \xi_j)^{2i\eta\nu(\xi_j)} e^{-2it\theta} \\ 0 & 1 \end{pmatrix}, & z \in \Sigma_{j1}^{mod}, \\ \begin{pmatrix} 1 & 0 \\ -\frac{\bar{r}(\xi_j)}{1-|\bar{r}(\xi_j)|^2} T_j(\xi_j)^{-2} (z - \xi_j)^{-2i\eta\nu(\xi_j)} e^{2it\theta} & 1 \end{pmatrix}, & z \in \Sigma_{j2}^{mod}, \\ \begin{pmatrix} 1 & r(\xi_j) T_j(\xi_j)^2 (z - \xi_j)^{2i\eta\nu(\xi_j)} e^{-2it\theta} \\ 0 & 1 \end{pmatrix}, & z \in \Sigma_{j3}^{mod}, \\ \begin{pmatrix} 1 & 0 \\ -\bar{r}(\xi_j) T_j(\xi_j)^{-2} (z - \xi_j)^{-2i\eta\nu(\xi_j)} e^{2it\theta} & 1 \end{pmatrix}, & z \in \Sigma_{j4}^{mod}. \end{cases} \quad (5.43)$$

(III) *Asymptotic behavior:* $M^{(mod),j}(z) = I + \mathcal{O}(z^{-1})$, as $z \rightarrow \infty$.

We give a detailed proof at phase point ξ_1 below for $\xi \in (-1/4, 0) \cup (0, 2)$, and the rest are similar. The jump contours corresponding to $\xi \in (0, 2)$ and $\xi \in (-1/4, 0)$ are show in Fig.7 and Fig.8, respectively.

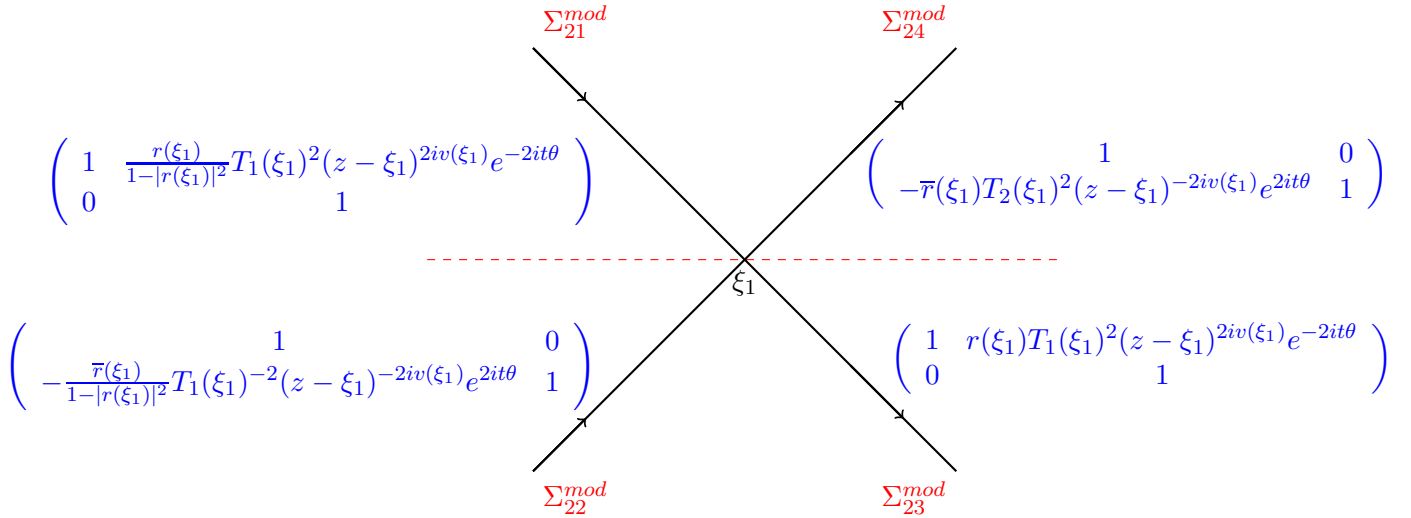

FIGURE 7. The jump condition $\Sigma_1^{(h)}$ and jump matrix in the region $\xi \in (0, 2)$ for the phase point ξ_1 .

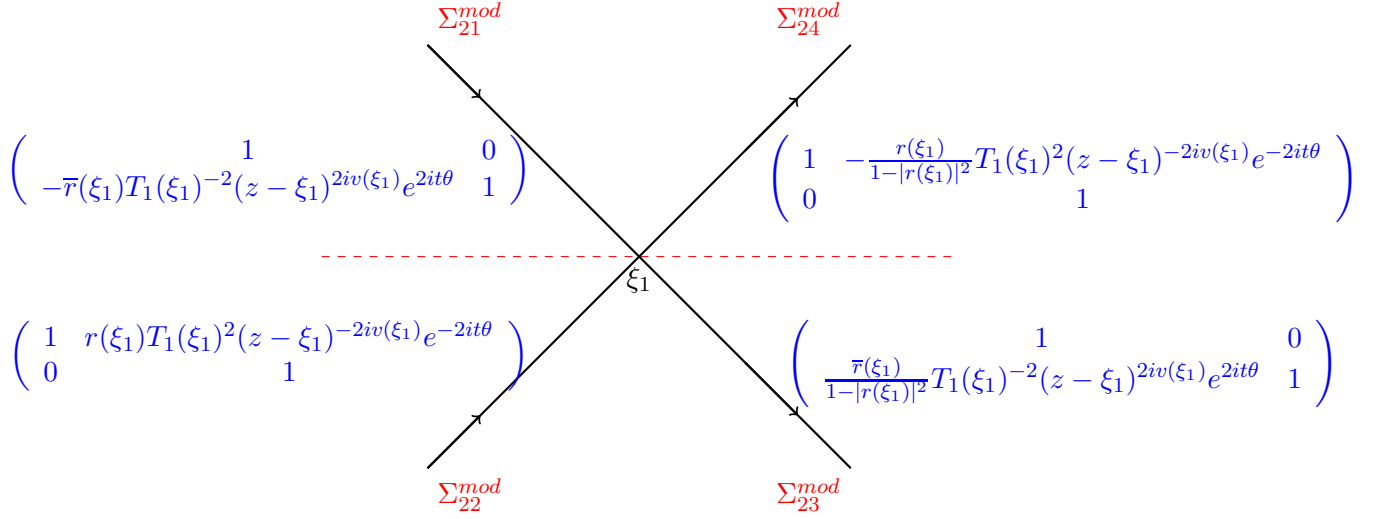

FIGURE 8. The jump condition $\Sigma_2^{(h)}$ and jump matrix in the region $\xi \in (-1/4, 0)$ for the phase point ξ_1 .

Introduce the variable

$$\zeta(z) = (2t\epsilon_j \phi''(\xi_j))^{1/2} (z - \xi_j), \quad j = 1, 2, \dots, n(\xi), \quad (5.44)$$

and let

$$r_{\xi_j} = r(\xi_j) T_j(\xi_j)^2 e^{-2it\theta(\xi_j)} e^{-i\eta v(\xi_j) \ln(2t\eta \theta''(\xi_j))}, \quad (5.45)$$

where $|r(\xi_j)|^2 = |r_{\xi_j}|^2$. Taking the branch of the logarithm with $0 < \arg \zeta < 2\pi$ for $\xi \in (0, 2)$ and $-\pi < \arg \zeta < \pi$ for $\xi \in (-1/4, 0)$. Following the idea [29, 45], one obtains the proposition as follows.

Proposition 5.11. *As $t \rightarrow \infty$,*

$$M^{(mod)}(z) = I + t^{-1/2} \sum_{k=1}^{n(\xi)} \frac{A_k(\xi)}{z - \xi_k} + O(t^{-1}), \quad (5.46)$$

where

$$A_k(\xi) = \frac{1}{\sqrt{2\eta\theta'''(\xi_k)}} \begin{pmatrix} 0 & -\beta_{12}^{\xi_k} \\ i\beta_{21}^{\xi_k} & 0 \end{pmatrix} \quad (5.47)$$

and as $\xi \in (0, 2)$, $k = 2, 4$, as $\xi \in (-1/4, 0)$, $k = 1, 3, 5, 7$

$$\beta_{12}^{\xi_k} = -\frac{\sqrt{2\pi} e^{-\frac{-\pi v(\xi_k)}{2}} e^{\frac{i\pi}{4}}}{\bar{r}_{\xi_k} \Gamma(-iv(\xi_k))}, \quad \beta_{12}^{\xi_k} \beta_{21}^{\xi_k} = v(\xi_k), \quad (5.48)$$

$$r_{\xi_k} = r(\xi_k) T_k(\xi)^2 e^{-2it\theta(\xi_k)} \exp(iv(\xi_k) \ln(2t\theta''(\xi_k))), \quad (5.49)$$

$$\arg(\beta_{12}^{\xi_k}) = \frac{\pi}{4} + \arg(r_{\xi_k}) - \arg(\Gamma(-iv(\xi_k))). \quad (5.50)$$

As $\xi \in (0, 2)$, $k = 1, 3$, as $\xi \in (-1/4, 0)$, $k = 2, 4, 6, 8$

$$\beta_{12}^{\xi_k} = -\frac{\sqrt{2\pi} e^{\frac{3\pi v(\xi_k)}{2}} e^{-\frac{5i\pi}{4}}}{\bar{r}_{\xi_k} \Gamma(iv(\xi_k))}, \quad \beta_{12}^{\xi_k} \beta_{21}^{\xi_k} = v(\xi_k), \quad (5.51)$$

$$r_{\xi_k} = r(\xi_k) T_k(\xi)^2 e^{-2it\theta(\xi_k)} \exp(iv(\xi_k) \ln(-2t\theta''(\xi_k))), \quad (5.52)$$

$$\arg(\beta_{12}^{\xi_k}) = -\frac{5\pi}{4} + \arg(r_{\xi_k}) - \arg(\Gamma(iv(\xi_k))). \quad (5.53)$$

Proof. See Appendix A. □

5.4. The small-norm RH problem. In this section, we will consider the problem that the error function $E(z)$ defined by (5.31) by the small norm RH problem. In reality, the error function such that

RH Problem 5.12. Find a 2×2 matrix function $E(z)$ satisfies that

(I) $E(z)$ is analytic in $\mathbb{C} \setminus \Sigma^{err}$, where

$$\Sigma^{err} = \partial U(\xi) \cup \left(\Sigma^{(2)} \setminus U(\xi) \right)$$

shown in Fig.9.

(II) Jump condition:

$$E_+(z) = E_-(z) V^{err}(z), \quad z \in \Sigma^{err}, \quad (5.54)$$

where

$$V^{err}(z) = \begin{cases} M^{(sol)}(z) V^{(2)}(z) M^{(sol)}(z)^{-1}, & z \in \Sigma^{(2)} \setminus U(\xi), \\ M^{(sol)}(z) M^{(mod)}(z) M^{(sol)}(z)^{-1}, & z \in \partial U(\xi). \end{cases}$$

(III) Asymptotic behavior

$$E(z) = I + O(z^{-1}), \quad z \rightarrow \infty. \quad (5.55)$$

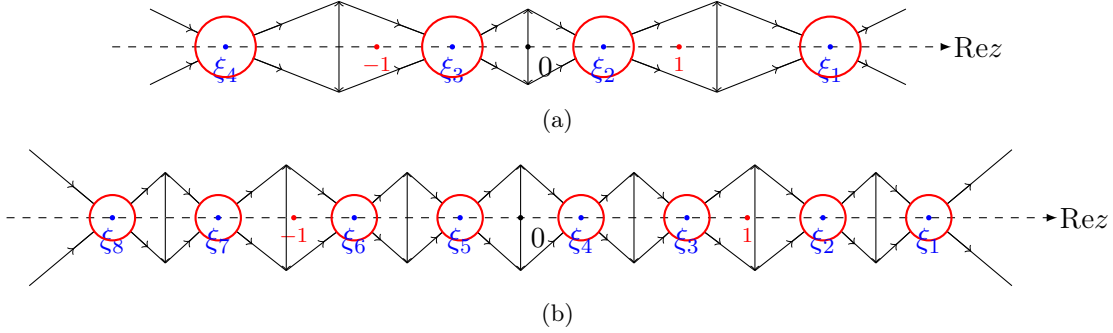

FIGURE 9. (a) and (b) denote the jump contour Σ^{err} as $\xi \in (0, 2)$ and $\xi \in (-1/4, 0)$, respectively. The red circles represent the jump contour $U(\xi)$ at each phase points ξ_j .

From the small norm theory of RH problem [29, 30, 44], it is necessary to further analyze the estimation of the jump matrix V^{err} of the error function $E(z)$. It follows from Proposition 5.5 that

$$\|V^{err} - I\|_{L^2} \lesssim \begin{cases} e^{-tK}, & z \in \Sigma_{kj} \setminus U(\xi), \\ e^{-tK'}, & z \in \Sigma_j^\pm, \\ t^{-1/2}, & z \in \partial U(\xi), \end{cases} \quad (5.56)$$

where it takes advantage of the fact that $M^{(sol)}$ is bounded for $z \in \partial U(\xi)$, which implies that the solution to RH problem 5.12 exists and is unique expressed by

$$E(z) = I + \frac{1}{2\pi i} \int_{\Sigma^{err}} \frac{(I + \rho(s))(V^{err} - I)}{s - z} ds, \quad (5.57)$$

where $\rho \in L^2(\Sigma^{err})$ is the unique solution of $(1 - C_{V^{err}})\rho = C_{V^{err}}I$ and $C_{V^{err}} : L^2(\Sigma^{err}) \rightarrow L^2(\Sigma^{err})$ is integral operator on Σ^{err}

$$C_{V^{err}}(f)(z) = C_- f(V^{err} - I) = \lim_{s \rightarrow z} \frac{1}{2\pi i} \int_{\Sigma^{err}} \frac{f(s)(V^{err}(s) - I)}{s - z} ds. \quad (5.58)$$

Then, an application of inequality (5.56) yields

$$\|C_{V^{err}}\| \leq \|C_-\|_{L^2 \rightarrow L^2} \|V^{err} - I\|_{L^2} \lesssim O(t^{-\frac{1}{2}}), \quad (5.59)$$

which indicates that as $t \rightarrow +\infty$, $1 - C_{V^{err}}$ is reversible and ρ exists and is unique. Also

$$\|\rho\|_{L^\infty(\Sigma^{err})} \lesssim \frac{\|C_{V^{err}}\|}{1 - \|C_{V^{err}}\|} \lesssim t^{-\frac{1}{2}}. \quad (5.60)$$

In order to recover the solution $q(x, t)$ of mCH equation, we need to further analyze the asymptotic behavior of error function $E(z)$ as $z \rightarrow i$, which is reflected in the following proposition.

Proposition 5.13. *As $z \rightarrow i$, the error function $E(z)$ satisfies that*

$$E(z) = E(i) + E_1(z - i) + O((z - i)^2), \quad (5.61)$$

where $E(i)$ and E_1 are determined by

$$E(i) = I + \frac{1}{2\pi i} \int_{\Sigma(E)} \frac{(I + \varpi(s))(V^{err} - I)}{s - i} ds, \quad (5.62a)$$

$$E_1 = -\frac{1}{2\pi i} \int_{\Sigma(E)} \frac{(I + \varpi(s))(V^{err} - I)}{(s - i)^2} ds, \quad (5.62b)$$

with the asymptotic behaviors

$$E(i) = I + t^{-1/2} f_1 + O(t^{-1}), \quad (5.63a)$$

$$E_1 = t^{-1/2} f_2 + O(t^{-1}), \quad (5.63b)$$

where

$$f_1 = -\sum_{j=1}^{n(\xi)} \frac{1}{(1 - \xi_j^{-2})(\xi_j - i)} M^{(sol)}(\xi_j) A_j \sigma_2 M^{(sol)}(\xi_j) \sigma_2, \quad (5.64a)$$

$$f_2 = \sum_{j=1}^{n(\xi)} \frac{1}{(1 - \xi_j^{-2})(\xi_j - i)^2} M^{(sol)}(\xi_j) A_j \sigma_2 M^{(sol)}(\xi_j) \sigma_2. \quad (5.64b)$$

For convenience, let denote the following notations

$$\begin{aligned} h_{11} = & - \left[(f_2^{21} M_{12}^{(sol)}(i) + f_2^{21} M_{12}^{(sol)}(i)) T(i) + (f_1^{11} M_{1,12}^{(sol)} + f_1^{12} M_{1,22}^{(sol)}) T(i) \right. \\ & \left. + (f_1^{11} M_{12}^{(sol)}(i) + f_1^{12} M_{22}^{(sol)}(i)) T(i) T_0 \right] (f_1^{11} M_{11}^{(sol)}(i) + f_1^{12} M_{21}^{(sol)}(i)) T(i) \\ & - \left[(f_2^{21} M_{11}^{(sol)}(i) + f_2^{22} M_{22}^{(sol)}(i)) T(i)^{-1} + (f_1^{21} M_{1,11}^{(sol)} + f_1^{22} M_{1,21}^{(sol)}) T(i)^{-1} \right. \\ & \left. - (f_1^{21} M_{11}^{(sol)}(i) + f_1^{22} M_{21}^{(sol)}(i)) T(i)^{-1} T_0 \right] (f_1^{11} M_{11}^{(sol)}(i) + f_1^{12} M_{21}^{(sol)}(i))^{-1} T(i)^{-1}, \quad (5.65) \end{aligned}$$

and

$$h_{12} = \ln \left[\left(1 + t^{-1/2} f_1^{11} \right) + \frac{M_{21}^{(sol)}(i)}{M_{11}^{(sol)}(i)} t^{-1/2} f_1^{12} \right], \quad (5.66)$$

where $M_1^{(sol)}$, $T(i)$, and T_0 are defined by (4.66), Proposition 4.1, as well as f_i^{jk} ($i, j, k = 1, 2$) denote the elements of the matrices f_1 and f_2 .

Proof. The proof of expression (5.62) is trivial. The following mainly proves (5.63) and (5.64). Applying the expression (5.57) yields

$$\begin{aligned}
E(i) &= I + \frac{1}{2\pi i} \left(\oint_{\partial U(\xi)} \frac{V^{err}(s) - I}{s - i} ds + \int_{\Sigma^{err} \setminus \partial U(\xi)} \frac{V^{err}(s) - I}{s - i} ds + \int_{\Sigma^{err}} \frac{\rho(s)(V^{err}(s) - I)}{s - i} ds \right) \\
&= I + \frac{1}{2\pi i} \oint_{\partial U(\xi)} \frac{V^{err}(s) - I}{s - i} ds + O(t^{-1}) \\
&= I + \frac{1}{2\pi i} \oint_{\partial U(\xi)} \frac{M^{(sol)}(s)(M^{(mod)} - I)M^{(sol)}(s)^{-1}}{s - i} ds + O(t^{-1}) \\
&= I + t^{-1/2} \frac{1}{2\pi i} \sum_{j=1}^{n(\xi)} \oint_{\partial U(\xi)} \frac{M^{(sol)}(s)A_j(\xi)M^{(sol)}(s)^{-1}}{(s - i)(s - \xi_j)} ds + O(t^{-1}) \\
&= I - t^{-1/2} \sum_{j=1}^{n(\xi)} \frac{M^{(sol)}(\xi_j)A_j(\xi)M^{(sol)}(\xi_j)^{-1}}{(\xi_j - i)} ds + O(t^{-1}) \\
&= I - t^{-1/2} \sum_{j=1}^{n(\xi)} \frac{M^{(sol)}(\xi_j)A_j(\xi)\sigma_2 M^{(sol)}(\xi_j)\sigma_2}{(\xi_j - i)(1 - \xi_j^{-2})} ds + O(t^{-1}) \triangleq I + t^{-1/2} f_1 + O(t^{-1}). \tag{5.67}
\end{aligned}$$

Similarly, the expression (5.64b) can be obtained in the same way. \square

5.5. Analysis on pure $\bar{\partial}$ -problem. Similar to Section 4.4, from this section we will analyze the pure $\bar{\partial}$ -problem $m^{(3)}(z)$

$$m^{(3)}(z) = M^{(2)}(z)M_{rhp}^{(2)}(z)^{-1}, \tag{5.68}$$

in the presence of steady-state phase points, that is, to remove soliton components from $M^{(2)}(z)$, which solves the pure $\bar{\partial}$ -problem 4.8 replaced the condition $W^{(3)}(z) = M^{(rhp)}(z)\bar{\partial}R^{(2)}(z)M^{(rhp)}(z)^{-1}$ by $W^{(3)}(z) = M_{rhp}^{(2)}(z)\bar{\partial}R^{(2)}(z)M_{rhp}^{(2)}(z)^{-1}$. Then the solution to equation (5.68) is given by

$$m^{(3)}(z) = I + \frac{1}{\pi} \iint_{\mathbb{C}} \frac{m^{(3)}(s)W^{(3)}(s)}{s - z} dA(s), \tag{5.69}$$

which can be rewritten as an operator equation

$$m^{(3)}(z) = I \cdot (I - \mathbb{P}_z)^{-1}, \tag{5.70}$$

where the operator \mathbb{P}_z is defined by (4.91).

Proposition 5.14. *As $t \rightarrow \infty$, the operator \mathbb{P}_z satisfies the following estimation*

$$\|\mathbb{P}_z\|_{L^\infty \rightarrow L^\infty} \lesssim t^{-1/4}. \tag{5.71}$$

which indicates that the operator $(I - \mathbb{P}_z)^{-1}$ exists.

Proof. Taking region $\xi \in (-1/4, 0)$ as an example, consider that for any $f \in L^\infty$

$$\|\mathbb{P}_z f\|_{L^\infty} \leq \|f\|_{L^\infty} \frac{1}{\pi} \int \int_{\mathbb{C}} \frac{|W^{(3)}(s)|}{|s-z|} dA(s), \quad (5.72)$$

where $W^{(3)}(s) = M^{(sol)}(s)\bar{\partial}R^{(2)}(s)M^{(sol)}(s)^{-1}$ and $W^{(3)}(s) \equiv 0$ as out $\bar{\Omega}$. On the other hand, $M^{(sol)}(s)$ and $M^{(sol)}(s)^{-1}$ are bounded as $z \in \bar{\Omega}$. Let $z = \alpha + i\beta$ and $s - \xi_1 = u + iv \in \Omega_{11}$, then

$$\|f\|_{L^\infty} \frac{1}{\pi} \int \int_{\Omega_{11}} \frac{|W^{(3)}(s)|}{|s-z|} dA(s) \leq \|f\|_{L^\infty} \frac{1}{\pi} \int \int_{\Omega_{11}} \frac{|\bar{\partial}R_{11}(s)|}{|s-z|} dA(s) \leq J_5 + J_6, \quad (5.73)$$

where

$$J_5 = \int \int_{\Omega_{11}} \frac{|p'_{11}(s)|e^{2t \operatorname{Im} \theta}}{|s-z|} dudv, \quad (5.74a)$$

$$J_6 = \int \int_{\Omega_{11}} \frac{|s-\xi_1|^{-1/2}e^{2t \operatorname{Im} \theta}}{|s-z|} dudv. \quad (5.74b)$$

For J_5 , applying Hölder inequality obtains

$$\begin{aligned} J_5 &\leq \int_0^\infty \| |p'_{11}(s)| \|_{L^2(v,\infty)} \| |s-z|^{-1} \|_{L^2(v,\infty)} e^{-4\tau(\xi)tv^2 \frac{v+\xi_1}{4+\xi_1^2+v^2}} dv, \\ &\lesssim \int_0^\infty |v-y|^{-1/2} e^{-4\tau(\xi)tv^2 \frac{v+\xi_1}{4+\xi_1^2+v^2}} dv \\ &= \int_0^y |v-y|^{-1/2} e^{-4\tau(\xi)tv^2 \frac{v+\xi_1}{4+\xi_1^2+v^2}} dv + \int_y^\infty |v-y|^{-1/2} e^{-4\tau(\xi)tv^2 \frac{v+\xi_1}{4+\xi_1^2+v^2}} dv \triangleq J_5^1 + J_5^2. \end{aligned} \quad (5.75)$$

For J_5^1 , it follows from $e^{-s} \leq s^{-1/4}$ that

$$\begin{aligned} J_5^1 &\leq \int_0^y (y-v)^{-1/2} v^{-1/2} t^{-1/4} dv \\ &= \int_0^y y^{-1/2} (1-v/y)^{-1/2} (v/y)^{-1/2} y^{-1/2} t^{-1/4} dv \\ &\stackrel{w=v/y}{=} \int_0^1 (1-w)^{-1/2} w^{-1/2} dw t^{-1/4} \lesssim t^{-1/4}. \end{aligned} \quad (5.76)$$

On the other hand, for J_5^2

$$\begin{aligned} J_5^2 &\stackrel{\kappa=v/y}{=} \int_0^\infty \kappa^{-1/2} e^{-2\tau(\xi)(\kappa+y)^2 \frac{\kappa+y+\xi_1}{4+\xi_1^2+(\kappa+y)^2}} d\kappa \\ &\leq \int_0^\infty \kappa^{-1/2} e^{-2\tau(\xi)t y \frac{\xi_1+y}{4+\xi_1^2+y^2}} d\kappa \lesssim e^{-2\tau(\xi)t y^2 \frac{\xi_1+y}{4+\xi_1^2+y^2}}. \end{aligned} \quad (5.77)$$

Observing the fact that $\| |s - \xi_1|^{-1/2} \|_{L^p} \lesssim v^{-1/p-1/2}$ and $\| |z - s|^{-1} \|_{L^q} \lesssim |v - y|^{1/q-1}$ for $p > 2$ satisfying $1/p + 1/q = 1$. Then

$$\begin{aligned}
J_6 &\lesssim \int_0^\infty \left\| |s - \xi_1|^{-1/2} \right\|_{L^p} \left\| |z - s|^{-1} \right\|_{L^q} e^{-4\tau(\xi)tv^2 \frac{v+\xi_1}{4+\xi_1^2+v^2}} dv \\
&\lesssim \int_0^\infty v^{-1/p-1/2} |v - y|^{1/q-1} e^{-4\tau(\xi)tv^2 \frac{v+\xi_1}{4+\xi_1^2+v^2}} dv \\
&= \int_0^y v^{-1/p-1/2} (y - v)^{1/q-1} e^{-4\tau(\xi)tv^2 \frac{v+\xi_1}{4+\xi_1^2+v^2}} dv + \int_y^\infty v^{-1/p-1/2} (v - y)^{1/q-1} e^{-4\tau(\xi)tv^2 \frac{v+\xi_1}{4+\xi_1^2+v^2}} dv
\end{aligned} \tag{5.78}$$

Similar to the proof of inequality (5.76) and (5.77), one has $J_6 \lesssim t^{-1/4}$. \square

Since restoring the solution $q(x, t)$ of the mCH equation needs to consider the asymptotic behavior at $z = i$, which is reflected in the following proposition.

Proposition 5.15. *The solution to (5.68) obeys the estimation as $t \rightarrow \infty$*

$$\left\| m^{(3)} - I \right\| = \left\| \frac{1}{\pi} \int \int_{\mathbb{C}} \frac{m^{(3)}(s)W^{(3)}(s)}{s - i} dA(s) \right\| \lesssim t^{-3/4}. \tag{5.79}$$

Then, The expansion at $z = i$ can be expressed as

$$m^{(3)}(z) = m^{(3)}(i) + m_1^{(3)}(x, t)(z - i) + O((z - i)^2), \tag{5.80}$$

where

$$m_1^{(3)}(x, t) = \frac{1}{\pi} \int \int_{\mathbb{C}} \frac{m^{(3)}(s)W^{(3)}(s)}{(s - i)^2} dA(s), \tag{5.81}$$

with

$$\left| m_1^{(3)}(x, t) \right| \lesssim t^{-3/4}. \tag{5.82}$$

Proof. Similar to the proof of Proposition 5.14, we still take $z \in \Omega_{11}$ in region $\xi \in (-1/4, 0)$ as an example, and first consider inequality (5.79). Observing the fact that $\|m^{(3)}\|_{L^\infty} \leq 1$. Let $s - \xi_1 = u + iv$ and $z = x + iy \in \Omega_{11}$, then

$$\frac{1}{\pi} \int \int_{\mathbb{C}} \frac{|m^{(3)}(s)W^{(3)}(s)|}{|s - i|} \leq J_7 + J_8, \tag{5.83}$$

where

$$J_7 = \int \int_{\Omega_{11}} \frac{|p'_{11}(s)|e^{2t \operatorname{Im} \theta}}{|s - i|} dudv, \tag{5.84a}$$

$$J_8 = \int \int_{\Omega_{11}} \frac{|s - \xi_1|^{-1/2} e^{2t \operatorname{Im} \theta}}{|s - i|} dudv. \tag{5.84b}$$

For the integral equation J_7 , it follows from Hölder inequality and $|s - i|^{-1}$ has nonzero maximum that

$$\begin{aligned}
J_7 &\leq \int_0^\infty \int_v^\infty |p'_{11}(s)| e^{-\tau(\xi)tv \frac{u^2+v^2+2u\xi_1}{4+|s|^2}} dudv \\
&\lesssim \int_0^\infty \|p'_{11}(s)\|_{L^2} \left\| e^{-\tau(\xi)tvu \frac{v+2\xi_1}{4+v^2+(v+\xi_1)^2}} \right\|_{L^2} e^{-\tau(\xi)tv^2 \frac{v+2\xi_1}{4+v^2+(v+\xi_1)^2}} dudv \\
&\lesssim t^{-1} \int_0^\infty \left(\frac{v^2 + 2v\xi_1}{4 + v^2 + (v + \xi_1)^2} \right)^2 e^{-\tau(\xi)tv^2 \frac{v+2\xi_1}{4+v^2+(v+\xi_1)^2}} dudv \\
&= t^{-1} \left[\left(\int_0^1 + \int_1^\infty \right) \left(\frac{v^2 + 2v\xi_1}{4 + v^2 + (v + \xi_1)^2} \right)^2 e^{-\tau(\xi)tv^2 \frac{v+2\xi_1}{4+v^2+(v+\xi_1)^2}} dv \right] \\
&\triangleq J_7^1 + J_7^2.
\end{aligned} \tag{5.85}$$

For the first integral J_7^1 , that is $v \in (0, 1)$, then one has $\frac{v^2+2v\xi_1}{4+v^2+(v+\xi_1)^2} \leq v^{-1}$. Therefore,

$$J_7^1 \lesssim \int_0^1 v^{-1/2} e^{-tv^2} dv \lesssim \int_0^1 t^{-1/4} e^{-(t^{1/4}v^{1/2})^4} dt^{1/4} v^{1/2} \lesssim t^{-1/4}. \tag{5.86}$$

Similarly, direct calculation shows

$$J_7^2 \lesssim \int_1^\infty e^{-t(v+\xi_1)} \lesssim t^{-1}. \tag{5.87}$$

Now our attention turns to proving J_8 . For $2 < p < 4$ such that $1/p + 1/q = 1$, applying Hölder inequality yields

$$\begin{aligned}
J_8 &\lesssim \int_0^\infty \left\| |s - \xi_1|^{-1/2} \right\|_{L^p} \left\| e^{-\tau(\xi)tvu \frac{v+2\xi_1}{4+v^2+(v+\xi_1)^2}} \right\|_{L^q} e^{-\tau(\xi)tv^2 \frac{v+2\xi_1}{4+v^2+(v+\xi_1)^2}} dv \\
&= t^{-\frac{1}{q}} \left[\left(\int_0^1 + \int_1^\infty \right) v^{\frac{1}{p}-\frac{1}{2}} \left(\frac{v^2 + 2v\xi_1}{4 + v^2 + (v + \xi_1)^2} \right)^{-\frac{1}{q}} e^{-q\tau(\xi)tv^2 \frac{v+2\xi_1}{4+v^2+(v+\xi_1)^2}} dv \right] \\
&\triangleq J_8^1 + J_8^2.
\end{aligned} \tag{5.88}$$

Similar to the proof of (5.85), one has $J_8 \leq t^{-3/4}$. On the other hand, because $|(s - i)^{-1}|$ is bounded, inequality (5.82) can be obtained by using results (5.79) and (5.81). \square

6. LONG-TIME ASYMPTOTIC BEHAVIORS

The main purpose of this section is to give the asymptotic behavior of the mCH equation depending on ξ with nonzero boundary conditions. First, a series of deformations of the original RH problem 2.6 are reviewed, including (4.21), (4.48), (4.57) and (4.64). Therefore, one has

$$M(z) = M^{(3)}(z)M^{(err)}(z)M^{(sol)}(z)R^{(2)}(z)^{-1}T(z)^{-\sigma_3} \tag{6.1}$$

In order to reconstruct the solution of the mCH equation, consider $z \rightarrow i$ outside the region $\overline{\Omega}$, then there is $R^{(2)}(z) \equiv 1$. It follows from Propositions 4.1 and 4.16

$$\begin{aligned} M(z) &= \left(M^{(3)}(i) + M_1^{(3)}(z)(z-i) \right) M^{(err)}(z) M^{(sol)}(z) T(i)^{-\sigma_3} \\ &\quad \times \left(1 - \frac{1}{2\pi i} \int_{\Sigma_b(\xi)} \frac{\ln(1-|r(s)|^2)}{(s-i)^2} ds (z-i) \right)^{-\sigma_3} + O((z-i)^2) \end{aligned} \quad (6.2)$$

For the regions $\xi \in (-\infty, -1/4) \cup (2, +\infty)$, the corresponding steady-state phase point does not exist, then

$$M(z) = M^{(sol)}(i) T(i)^{-\sigma_3} \left(1 - \frac{1}{2\pi i} \int_{\Sigma_b(\xi)} \frac{\ln(1-|r(s)|^2)}{(s-i)^2} ds (z-i) \right)^{-\sigma_3} + O((z-i)^2) + O(t^{-1/4}), \quad (6.3)$$

and

$$M(z) = M^{(sol)}(i) T(i)^{-\sigma_3} + O(t^{-1/4}). \quad (6.4)$$

Applying the reconstruction formula (2.43) yields

$$\begin{aligned} q(x, t) &= -\partial_z M_{12}(z)|_{z=i} M_{11}(i) - \partial_z M_{21}(z)|_{z=i} M_{11}(i)^{-1} \\ &= -\partial_z M_{12}^{(sol)}(z)|_{z=i} M_{11}^{(sol)}(i) - \partial_z M_{21}^{(sol)}(z)|_{z=i} M_{11}^{(sol)}(i)^{-1} + O(t^{-1/4}) \\ &= q_{sol}(x, t, \Lambda) + O(t^{-1/4}), \end{aligned} \quad (6.5)$$

and

$$x(y, t) = y + 2 \ln(T(i)) + c_+ + O(t^{-1/4}). \quad (6.6)$$

Similarly, the same treatment can be done for the regions $\xi \in (-1/4, 0) \cup (0, 2)$, which is summarized as the following theorem.

Theorem 6.1. *Let $q(x, t)$ be the solution of mCH equation (1.7) corresponding to initial data $q_0(x) \in H^{2,1}(\mathbb{R})$ and assume that $q_0(x)$ is generic. Let $\left\{ r(z), \{\eta_n, c_n\}_{n=1}^{4N_1+2N_2} \right\}$ be the scattering data generated by the initial data $q_0(x)$ and $q_{sol}(x, t, \Lambda)$ denote the $N(\Lambda)$ -soliton solution with the modified scattering data $\sigma_d^\Lambda = \{0, \{\eta_n, c_n T^2(\eta_n)\}_{n \in \Lambda}\}$ shown in Corollary 4.12. Then the solution to the mCH equation can be described as follow: as $t \rightarrow +\infty$*

(I) *As $\xi \in (-\infty, -1/4) \cup (2, +\infty)$, then*

$$q(x, t) = q_{sol}(x, t, \Lambda) + O(t^{-1/4}), \quad (6.7)$$

$$x(y, t) = y + 2 \ln(T(i)) + c_+ + O(t^{-1/4}), \quad (6.8)$$

where the parameters $q_{sol}(x, t, \Lambda)$, c_+ and $T(i)$ are defined in Corollary 4.12 and Proposition 4.1.

(II) As $\xi \in (-1/4, 0) \cup (0, 2)$, then

$$q(x, t) = q_{sol}(x, t, \Lambda)(1 + T_0) + t^{-1/2}h_{11} + O(t^{-3/4}), \quad (6.9)$$

$$x(y, t) = y + 2 \ln(T(i)) + c'_+ + t^{-1/2}h_{12} + O(t^{-3/4}) \quad (6.10)$$

where the parameters h_{11} , h_{12} and $\ln(T(i))$ are defined in Proposition 5.13 and Proposition 4.1.

ACKNOWLEDGEMENTS

This work was supported by the National Natural Science Foundation of China under Grant No. 11975306, the Natural Science Foundation of Jiangsu Province under Grant No. BK20181351, the Six Talent Peaks Project in Jiangsu Province under Grant No. JY-059, and the Fundamental Research Fund for the Central Universities under the Grant Nos. 2019ZDPY07 and 2019QNA35.

APPENDIX A. THE PROOF OF PROPOSITION 5.11

In this appendix, we will prove in detail the match with parabolic cylindrical function at phase point ξ_1 for $\xi \in (-1/4, 0) \cup (0, 2)$.

A.1. **Local model for $\xi \in (0, 2)$.** Now let's first consider region $\xi \in (0, 2)$, which corresponds to $\theta''(\xi_1) > 0$.

RH Problem A.1. Find a 2×2 matrix $M^{(pc), \xi_1}(\zeta)$ such that

- (I) $M^{(pc), \xi_1}(\zeta)$ is analytic in analytic in $\mathbb{C} \setminus \Sigma^{pc}$, where $\Sigma^{pc} = \{\mathbb{R}e^{i\varphi}\} \cup \{\mathbb{R}e^{i(\pi-\varphi)}\}$ shown in Fig.A1.
- (II) Jump condition:

$$M_+^{(pc), \xi_1}(\zeta) = M_-^{(pc), \xi_1}(\zeta)V^{PC}(\zeta), \quad \zeta \in \Sigma^{pc}, \quad (A.1)$$

where

$$V^{PC}(\zeta) = \begin{cases} \zeta^{iv\hat{\sigma}_3} e^{-\frac{i\zeta^2}{4}\hat{\sigma}_3} \begin{pmatrix} 1 & 0 \\ -\bar{r}_{\xi_1} & 1 \end{pmatrix}, & \zeta \in \mathbb{R}^+ e^{i\varphi}, \\ \zeta^{iv\hat{\sigma}_3} e^{-\frac{i\zeta^2}{4}\hat{\sigma}_3} \begin{pmatrix} 1 & \frac{r_{\xi_1}}{1-|r_{\xi_1}|^2} \\ 0 & 1 \end{pmatrix}, & \zeta \in \mathbb{R}^+ e^{i(\pi-\varphi)}, \\ \zeta^{iv\hat{\sigma}_3} e^{-\frac{i\zeta^2}{4}\hat{\sigma}_3} \begin{pmatrix} 1 & 0 \\ -\frac{r_{\xi_1}}{1-|r_{\xi_1}|^2} & 1 \end{pmatrix}, & \zeta \in \mathbb{R}^+ e^{i(-\pi+\varphi)}, \\ \zeta^{iv\hat{\sigma}_3} e^{-\frac{i\zeta^2}{4}\hat{\sigma}_3} \begin{pmatrix} 1 & -r_{\xi_1} \\ 0 & 1 \end{pmatrix}, & \zeta \in \mathbb{R}^+ e^{-i\varphi}. \end{cases} \quad (A.2)$$

(III) Asymptotic behavior:

$$M^{(pc), \xi_1}(\zeta) = I + \frac{M_1^{(pc), \xi_1}(\zeta)}{\zeta} + O(\zeta^{-2}), \quad \zeta \rightarrow \infty. \quad (A.3)$$

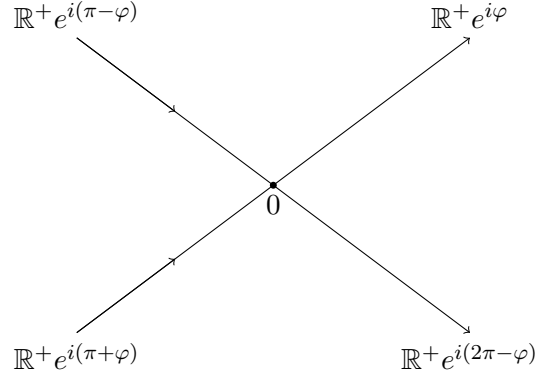

FIGURE A1. The contour Σ^{pc} for the case of ξ_1 in the region $\xi \in (0, 2)$.

The next goal is to further reduce RH problem A.1 to a model RH problem, whose solution can be given by using the asymptotic properties of parabolic cylindrical functions. Like the standard NLS equation and mKdV equation (see [27, 28, 42]), we make the following transformation

$$M^{(pc), \xi_1}(\zeta) = \Psi(\zeta) \mathcal{P} \zeta^{-i\nu\sigma_3} e^{\frac{i}{4}\zeta^2\sigma_3}, \quad (\text{A.4})$$

where

$$\mathcal{P}(\xi) = \begin{cases} \begin{pmatrix} 1 & 0 \\ \bar{r}_{\xi_1} & 1 \end{pmatrix}, & \arg \zeta \in (0, \varphi), \\ \begin{pmatrix} 1 & r_{\xi_1} \\ 0 & 1 \end{pmatrix}, & \arg \zeta \in (2\pi - \varphi), \\ \begin{pmatrix} 1 & 0 \\ -\frac{\bar{r}_{\xi_1}}{1+|r_{\xi_1}|^2} & 1 \end{pmatrix}, & \arg \zeta \in (\pi, \pi + \varphi), \\ \begin{pmatrix} 1 & -\frac{r_{\xi_1}}{1+|r_{\xi_1}|^2} \\ 0 & 1 \end{pmatrix}, & \arg \zeta \in (\pi - \varphi, \pi). \end{cases}$$

Through calculation, it is known that matrix $\Psi(\zeta)$ has the same constant jump matrix V^Ψ along the positive real axis and the negative real axis. Additionally, the matrix $\Psi(\zeta)$ satisfies the following RH problem.

RH Problem A.2. *The matrix $\Psi(\zeta)$ is analytic in $\mathbb{C} \setminus \mathbb{R}$ with the following properties*

(I) *For $\zeta \in \mathbb{R}$, the continuous values $\Psi_\pm(\zeta)$ on \mathbb{R} satisfy that*

$$\Psi_+(\zeta) = \Psi_-(\zeta) V^\Psi(\zeta), \quad \zeta \in \mathbb{R}, \quad (\text{A.5})$$

$$\text{where } V^\Psi(\zeta) = \begin{pmatrix} 1 - |r_{\xi_1}|^2 & r_{\xi_1} \\ -\bar{r}_{\xi_1} & 1 \end{pmatrix}.$$

(II) *Asymptotic behavior:*

Proposition A.3. *The entries of the matrix $\Psi(\zeta) = (\psi)_{2 \times 2}$ obey ordinary differential equation system as follows.*

$$\frac{d^2\psi_{11}(\zeta)}{d\zeta^2} + \left(\frac{i}{2} + \frac{\zeta^2}{4} - \beta_{21}^{\xi_1}\beta_{12}^{\xi_1}\right)\psi_{11} = 0, \quad \frac{d^2\psi_{21}(\zeta)}{d\zeta^2} + \left(-\frac{i}{2} + \frac{\zeta^2}{4} - \beta_{21}^{\xi_1}\beta_{12}^{\xi_1}\right)\psi_{21} = 0, \quad (\text{A.6})$$

$$\frac{d^2\psi_{12}(\zeta)}{d\zeta^2} + \left(\frac{i}{2} + \frac{\zeta^2}{4} - \beta_{21}^{\xi_1}\beta_{12}^{\xi_1}\right)\psi_{12} = 0, \quad \frac{d^2\psi_{22}(\zeta)}{d\zeta^2} + \left(-\frac{i}{2} + \frac{\zeta^2}{4} - \beta_{21}^{\xi_1}\beta_{12}^{\xi_1}\right)\psi_{22} = 0, \quad (\text{A.7})$$

Proof. Differentiating (A.5) and combining with $\frac{1}{2}i\zeta\sigma_3\Psi_+ = \frac{1}{2}i\zeta\sigma_3\Psi_-$ obtains

$$\left(\frac{d\Psi}{d\zeta} + \frac{i}{2}\zeta\sigma_3\Psi\right)_+ = \left(\frac{d\Psi}{d\zeta} + \frac{i}{2}\zeta\sigma_3\Psi\right)_- V^\Psi(\zeta). \quad (\text{A.8})$$

Observing that $\det V^\Psi(\zeta) \equiv 1$, then one has $\det \Psi_+ = \det \Psi_-$ and $\det \Psi$ is analytic in the ζ -plane. Applying Liouville theorem yields that $\det \Psi = 1$ and Ψ^{-1} . Additionally, the matrix-valued function $\left(\frac{d\Psi}{d\zeta} + \frac{i}{2}\zeta\sigma_3\Psi\right)(\Psi)^{-1}$ has no jump condition along the real axis \mathbb{R} and is an entire function with respect to ζ . By direct calculation, we can get

$$\begin{aligned} \left(\frac{d\Psi}{d\zeta} + \frac{i}{2}\zeta\sigma_3\Psi\right)(\Psi)^{-1} &= \left(\frac{dM^{(pc),\xi_1}(\zeta)}{d\zeta} + M^{(pc),\xi_1}(\zeta)\frac{i\nu\sigma_3}{\zeta}\right)M^{(pc),\xi_1}(\zeta)^{-1} \\ &\quad - \frac{i}{2}\zeta \left[M^{(pc),\xi_1}(\zeta), \sigma_3\right] M^{(pc),\xi_1}(\zeta)^{-1}. \end{aligned} \quad (\text{A.9})$$

It follows from Liouville theorem that there exists a constant matrix β^{ξ_1} such that

$$\beta^{\xi_1} = -\frac{i}{2} \left[M^{(pc),\xi_1}(\zeta), \sigma_3\right] = \begin{pmatrix} 0 & i[M^{(pc),\xi_1}(\zeta)]_{12} \\ -i[M^{(pc),\xi_1}(\zeta)]_{21} & 0 \end{pmatrix} \triangleq \begin{pmatrix} 0 & \beta_{12}^{\xi_1} \\ \beta_{21}^{\xi_1} & 0 \end{pmatrix}. \quad (\text{A.10})$$

Also using Liouville theorem again, one has

$$\left(\frac{d\Psi}{d\zeta} + \frac{i}{2}\zeta\sigma_3\Psi\right) = \beta^{\xi_1}\Psi. \quad (\text{A.11})$$

Expanding (A.11) yields that

$$\begin{aligned} \frac{d\psi_{11}}{d\zeta} + \frac{i}{2}\zeta\psi_{11} &= \beta_{12}^{\xi_1}\psi_{21}, & \frac{d\psi_{21}}{d\zeta} - \frac{i}{2}\zeta\psi_{21} &= \beta_{21}^{\xi_1}\psi_{11}, \\ \frac{d\psi_{12}}{d\zeta} + \frac{i}{2}\zeta\psi_{12} &= \beta_{12}^{\xi_1}\psi_{22}, & \frac{d\psi_{22}}{d\zeta} - \frac{i}{2}\zeta\psi_{22} &= \beta_{21}^{\xi_1}\psi_{12}. \end{aligned}$$

Direct calculation can get the results of Proposition A.3. □

Attention now turns to solving $\beta_{12}^{\xi_1}$ and $\beta_{21}^{\xi_1}$. As in [27], the parabolic cylinder (PC) equation

$$y'' + \left(\frac{1}{2} - \frac{z^2}{4} - a\right)y = 0, \quad (\text{A.12})$$

where the PC functions $D_a(z)$, $D_a(-z)$, $D_{-a-1}(iz)$ and $D_{-a-1}(-iz)$ are entire functions for any a with the asymptotic behavior as $z \rightarrow \infty$

$$D_a(z) = \begin{cases} z^a e^{-\frac{z^2}{4}} (1 + O(z^{-2})), & |\arg z| < \frac{3\pi}{4}, \\ z^a e^{-\frac{z^2}{4}} (1 + O(z^{-2})) - \frac{\sqrt{2\pi}}{\Gamma(-a)} e^{ia\pi} z^{-a-1} e^{z^2/4} (1 + O(z^{-2})), & \frac{\pi}{4} < \arg z < \frac{5\pi}{4}, \\ z^a e^{-\frac{z^2}{4}} (1 + O(z^{-2})) - \frac{\sqrt{2\pi}}{\Gamma(-a)} e^{-ia\pi} z^{-a-1} e^{z^2/4} (1 + O(z^{-2})), & -\frac{5\pi}{4} < \arg z < -\frac{\pi}{4}. \end{cases} \quad (\text{A.13})$$

Proposition A.4. *RH problem A.2 has the unique solution with the following forms*

$$\Psi(\zeta) = \begin{pmatrix} e^{-\frac{3\pi}{4}v(\xi_1)} D_{iv(\xi_1)}(\zeta e^{-\frac{3\pi i}{4}}) & \frac{e^{\frac{\pi}{4}(v(\xi_1)-i)}}{\beta_{21}^{\xi_1}} (-iv(\xi_1)) D_{-iv(\xi_1)-1}(\zeta e^{-\frac{\pi i}{4}}) \\ \frac{e^{\frac{\pi}{4}(v(\xi_1)-i)}}{\beta_{21}^{\xi_1}} iv(\xi_1) D_{iv(\xi_1)-1}(\zeta e^{-\frac{\pi i}{4}}) & e^{\frac{\pi}{4}v(\xi_1)} D_{-iv(\xi_1)}(\zeta e^{-\frac{\pi i}{4}}) \end{pmatrix}, \quad (\text{A.14})$$

for $\text{Im}(\zeta) > 0$ and for $\text{Im}(\zeta) < 0$

$$\Psi(\zeta) = \begin{pmatrix} e^{\frac{\pi}{4}v(\xi_1)} D_{iv(\xi_1)}(\zeta e^{\frac{\pi i}{4}}) & -\frac{iv(\xi_1)}{\beta_{21}^{\xi_1}} e^{-\frac{3\pi}{4}(v(\xi_1)-i)} D_{-iv(\xi_1)-1}(\zeta e^{\frac{3\pi i}{4}}) \\ \frac{iv(\xi_1)}{\beta_{12}^{\xi_1}} e^{\frac{\pi}{4}(v(\xi_1)+i)} D_{iv(\xi_1)-1}(\zeta e^{\frac{\pi i}{4}}) & e^{-\frac{3\pi}{4}v(\xi_1)} D_{-iv(\xi_1)}(\zeta e^{\frac{3\pi i}{4}}) \end{pmatrix}. \quad (\text{A.15})$$

Proof. Let $v = \beta_{12}^{\xi_1} \beta_{21}^{\xi_1}$, then the first equation of (A.6) can be rewritten as

$$\frac{d^2 \psi_{11}}{d\eta^2} + \left(\frac{1}{2} - \frac{\eta^2}{4} + iv \right) \psi_{11} = 0, \quad (\text{A.16})$$

under the new variable $\eta = \zeta e^{-\frac{3\pi i}{4}}$ for $\text{Im}(\zeta) > 0$, which has a set of linearly independent solutions for some constants c_1 and c_2

$$\psi_{11} = c_1 D_a(e^{-\frac{3\pi i}{4}} \zeta) + c_2 D_a(-e^{-\frac{3\pi i}{4}} \zeta).$$

Due to $\zeta \in \mathbb{C}^+$, thus $-\frac{3\pi}{4} < \arg \eta < \frac{\pi}{4}$. Combining the asymptotic behavior Ψ with the properties of $D_a(z)$ yields the result

$$\psi_{11} = e^{-\frac{3\pi}{4}v(\xi_1)} D_{iv(\xi_1)}(e^{-\frac{3\pi i}{4}} \zeta). \quad (\text{A.17})$$

On the other hand, applying (A.6) yields

$$\begin{aligned} \psi_{21} &= \frac{1}{\beta_{21}^{\xi_1}} \left[e^{-\frac{3\pi}{4}v(\xi_1)} \partial(D_{iv(\xi_1)}(e^{-\frac{3\pi i}{4}} \zeta)) + \frac{i\zeta}{2} e^{-\frac{3\pi}{4}v(\xi_1)} D_{iv(\xi_1)}(e^{-\frac{3\pi i}{4}} \zeta) \right] \\ &= \frac{1}{\beta_{21}^{\xi_1}} e^{-\frac{3\pi}{4}(v(\xi_1)+i)} \left[\partial(D_{iv(\xi_1)}(e^{-\frac{3\pi i}{4}} \zeta)) + \frac{\zeta}{2} e^{-\frac{3\pi i}{4}} D_{iv(\xi_1)}(e^{-\frac{3\pi i}{4}} \zeta) \right] \\ &= \frac{1}{\beta_{21}^{\xi_1}} e^{-\frac{3\pi}{4}(v(\xi_1)+i)} D_{iv(\xi_1)-1}(e^{-\frac{3\pi i}{4}} \zeta). \end{aligned} \quad (\text{A.18})$$

Similarly, for ψ_{22} , taking the new variable $\eta = e^{-\frac{\pi i}{4}} \zeta$

$$\psi_{22}'' + \left(-\frac{\zeta^2}{4} - iv + \frac{1}{2} \right) \psi_{22} = 0,$$

also

$$\psi_{22} = e^{\frac{\pi v}{4}} D_{-iv} \left(e^{-\frac{\pi}{4}} \zeta \right), \quad \zeta \in \mathbb{C}^+.$$

Then, one has

$$\psi_{12} = \frac{1}{\beta_{21}} e^{\frac{\pi v}{4}} \left(\partial_\zeta (D_{-iv}(\zeta e^{-\frac{i\pi}{4}})) - \frac{i\zeta}{2} D_{-iv}(\zeta e^{-\frac{i\pi}{4}}) \right).$$

As $\text{Im}(\zeta) < 0$, we take the transformations $\eta = \zeta e^{i\pi/4}$ and $\eta = \zeta e^{3\pi i/4}$ to solve ψ_{11} , ψ_{21} and ψ_{22} by repeating the above process, respectively. \square

Next, we turn our attention to solving $\beta_{12}^{\xi_1}$. It follows from (A.5) that

$$\begin{aligned} -\bar{r}_{\xi_1} &= \psi_{11}^- \psi_{21}^+ - \psi_{21}^- \psi_{11}^+ \\ &= e^{\frac{\pi}{4} v(\xi_1)} D_{iv(\xi_1)} \left(e^{\frac{\pi i}{4}} \zeta \right) \frac{e^{-\frac{3\pi v(\xi_1)}{4}}}{\beta_{12}^{\xi_1}} \left[\partial_\zeta (D_{iv(\xi_1)}(e^{-\frac{3\pi i}{4}} \zeta)) + \frac{i\zeta}{2} (D_{iv(\xi_1)}(e^{-\frac{3\pi i}{4}} \zeta)) \right] \\ &\quad - e^{-\frac{3\pi v(\xi_1)}{4}} \frac{e^{\frac{\pi v(\xi_1)}{4}}}{\beta_{12}^{\xi_1}} D_{iv(\xi_1)} \left(e^{-\frac{3\pi i}{4}} \zeta \right) \left[\partial_\zeta (D_{iv(\xi_1)}(e^{\frac{\pi i}{4}} \zeta)) + \frac{i\zeta}{2} D_{iv(\xi_1)}(e^{\frac{\pi i}{4}} \zeta) \right] \\ &= \frac{1}{\beta_{12}^{\xi_1}} \frac{\sqrt{2\pi} e^{\frac{\pi i}{4}} e^{-\frac{\pi v(\xi_1)}{2}}}{\Gamma(-iv(\xi_1))}, \end{aligned} \tag{A.19}$$

which implies that

$$\beta_{12}^{\xi_1} = -\frac{\sqrt{2\pi} e^{\frac{\pi i}{4}} e^{-\frac{\pi v(\xi_1)}{2}}}{\bar{r}_{\xi_1} \Gamma(-iv(\xi_1))}, \quad \beta_{12}^{\xi_1} \beta_{21}^{\xi_1} = v(\xi_1), \tag{A.20}$$

$$\arg(\beta_{12}^{\xi_1}) = \frac{\pi}{4} + \arg(r_{\xi_1}) - \arg(\Gamma(-iv(\xi_1))). \tag{A.21}$$

A.2. Local model for $\xi \in (-1/4, 0)$. Now let's first consider region $\xi \in (-1/4, 0)$, which corresponds to $\theta''(\xi_1) < 0$.

RH Problem A.5. *The matrix $M^{(pc), \xi_1}(\zeta)$ solves RH problem A.1 by replaced the jump condition*

$$V^{PC}(\zeta) = \begin{cases} \zeta^{-iv\widehat{\sigma}_3} e^{\frac{i\zeta^2}{4}\widehat{\sigma}_3} \begin{pmatrix} 1 & \frac{r_{\xi_1}}{1-|r_{\xi_1}|^2} \\ 0 & 1 \end{pmatrix}, & \zeta \in \mathbb{R}^+ e^{i\varphi}, \\ \zeta^{-iv\widehat{\sigma}_3} e^{\frac{i\zeta^2}{4}\widehat{\sigma}_3} \begin{pmatrix} 1 & 0 \\ -\bar{r}_{\xi_1} & 1 \end{pmatrix}, & \zeta \in \mathbb{R}^+ e^{i(\pi-\varphi)}, \\ \zeta^{-iv\widehat{\sigma}_3} e^{\frac{i\zeta^2}{4}\widehat{\sigma}_3} \begin{pmatrix} 1 & r_{\xi_1} \\ 0 & 1 \end{pmatrix}, & \zeta \in \mathbb{R}^+ e^{i(-\pi+\varphi)}, \\ \zeta^{-iv\widehat{\sigma}_3} e^{\frac{i\zeta^2}{4}\widehat{\sigma}_3} \begin{pmatrix} 1 & 0 \\ -\frac{\bar{r}_{\xi_1}}{1-|r_{\xi_1}|^2} & 1 \end{pmatrix}, & \zeta \in \mathbb{R}^+ e^{-i\varphi}, \end{cases} \quad (\text{A.22})$$

and the jump contour is shown in Fig. A2.

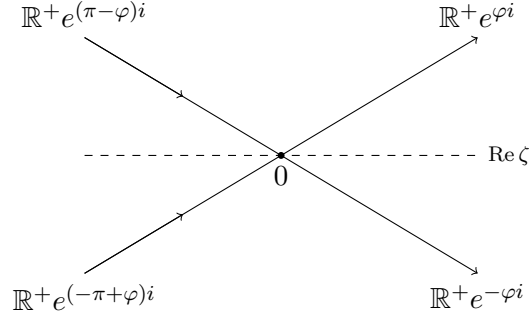

FIGURE A2. The contour Σ^{pc} for the case of ξ_1 in the region $\xi \in (-1/4, 0)$.

Similarly, we take the transformation as [27, 28, 42]

$$M^{(pc), \xi_1}(\zeta) = \Psi(\zeta) \mathcal{P} \zeta^{-iv\sigma_3} e^{\frac{i}{4}\zeta^2 \sigma_3}, \quad (\text{A.23})$$

where

$$\mathcal{P}(\xi) = \begin{cases} \begin{pmatrix} 1 & -\frac{\bar{r}_{\xi_1}}{1+|r_{\xi_1}|^2} \\ 0 & 1 \end{pmatrix}, & \arg \zeta \in (0, \varphi), \\ \begin{pmatrix} 1 & r_{\xi_1} \\ -\frac{r_{\xi_1}}{1+|r_{\xi_1}|^2} & 1 \end{pmatrix}, & \arg \zeta \in (-\varphi, 0), \\ \begin{pmatrix} 1 & r_{\xi_1} \\ 0 & 1 \end{pmatrix}, & \arg \zeta \in (-\pi, -\pi + \varphi), \\ \begin{pmatrix} 1 & 0 \\ \bar{r}_{\xi_1} & 1 \end{pmatrix}, & \arg \zeta \in (\pi - \varphi, \pi). \end{cases}$$

RH Problem A.6. *The matrix Ψ solves RH problem A.5 with the asymptotic behavior replaced by*

$$\Psi(\zeta) = \left(I + \frac{\psi_1}{\zeta} + O(\zeta^{-2}) \right) \zeta^{iv\sigma_3} e^{-\frac{i}{4}\zeta^2\sigma_3}, \quad \zeta \rightarrow \infty. \quad (\text{A.24})$$

Similar to Section A.1, the matrix Ψ satisfied by RH problem A.6 follows a ordinary differential equation system, which can be solved by PC model.

Proposition A.7. *The entries of matrix $\Psi = (\psi)_{2 \times 2}$ satisfy the following system*

$$\frac{d\psi_{11}}{d\zeta} - \frac{i\zeta}{2}\psi_{11} = \beta_{12}\psi_{21}, \quad \frac{d\psi_{21}}{d\zeta} + \frac{i\zeta}{2}\psi_{21} = \beta_{21}\psi_{11}, \quad (\text{A.25})$$

$$\frac{d\psi_{12}}{d\zeta} - \frac{i\zeta}{2}\psi_{12} = \beta_{12}\psi_{22}, \quad \frac{d\psi_{22}}{d\zeta} + \frac{i\zeta}{2}\psi_{22} = \beta_{21}\psi_{12}. \quad (\text{A.26})$$

It follows from PC equation and asymptotic behavior (A.13) that we obtain the unique solution to RH problem A.6.

Proposition A.8. *RH problem A.6 has the unique solution with the following forms*

$$\Psi(\zeta) = \begin{pmatrix} e^{\frac{\pi}{4}v(\xi_1)} D_{-iv(\xi_1)}(\zeta e^{-\frac{\pi i}{4}}) & \frac{e^{-\frac{3\pi}{4}(v(\xi_1)+i)}}{\beta_{21}^{\xi_1}} (iv(\xi_1)) D_{iv(\xi_1)-1}(\zeta e^{-3\frac{\pi i}{4}}) \\ -\frac{e^{\frac{\pi}{4}(v(\xi_1)-i)}}{\beta_{12}^{\xi_1}} iv(\xi_1) D_{-iv(\xi_1)-1}(\zeta e^{-\frac{\pi i}{4}}) & e^{-\frac{3\pi}{4}v(\xi_1)} D_{iv(\xi_1)}(\zeta e^{-\frac{3\pi i}{4}}) \end{pmatrix}, \quad (\text{A.27})$$

for $\text{Im}(\zeta) > 0$ and for $\text{Im}(\zeta) < 0$

$$\Psi(\zeta) = \begin{pmatrix} e^{\frac{5\pi}{4}v(\xi_1)} D_{-iv(\xi_1)}(\zeta e^{-\frac{5\pi i}{4}}) & \frac{iv(\xi_1)}{\beta_{21}^{\xi_1}} e^{-\frac{\pi}{4}(v(\xi_1)+i)} D_{iv(\xi_1)-1}(\zeta e^{-\frac{7\pi i}{4}}) \\ -\frac{iv(\xi_1)}{\beta_{12}^{\xi_2}} e^{\frac{5\pi}{4}(v(\xi_1)-i)} D_{-iv(\xi_1)-1}(\zeta e^{-\frac{5\pi i}{4}}) & e^{-\frac{7\pi}{4}v(\xi_1)} D_{iv(\xi_1)}(\zeta e^{-\frac{7\pi i}{4}}) \end{pmatrix}. \quad (\text{A.28})$$

Utilizing the equality $D'_a(z) + \frac{z}{2}D_a(z) = aD_{a-1}(z)$ and from the jump condition (A.8), one has

$$\begin{aligned} -\bar{r}_{\xi_1} &= \psi_{-,11}\psi_{+,21} - \psi_{-,21}\psi_{+,11} \\ &= \frac{e^{\frac{3\pi}{2}v(\xi_1)} \sqrt{2\pi} e^{-\frac{5\pi i}{4}}}{\beta_{12}^{\xi_1} \Gamma(iv(\xi_1))}, \end{aligned} \quad (\text{A.29})$$

from which we obtain

$$\beta_{12}^{\xi_1} = -\frac{e^{\frac{3\pi}{2}v(\xi_1)} \sqrt{2\pi} e^{-\frac{5\pi i}{4}}}{\beta_{12}^{\xi_1} \bar{r}_{\xi_1} \Gamma(iv(\xi_1))}, \quad \beta_{12}^{\xi_1} \beta_{21}^{\xi_1} = v(\xi_1), \quad (\text{A.30})$$

$$\arg(\beta_{12}^{\xi_1}) = -\frac{5\pi}{4} + \arg(r_{\xi_1}) - \arg(\Gamma(iv(\xi_1))). \quad (\text{A.31})$$

REFERENCES

- [1] S. Anco and D. Kraus, Hamiltonian structure of peakons as weak solutions for the modified Camassa-Holm equation, *Discrete Contin. Dyn. Syst.* 38 (2018) 4449-4465.
- [2] R. Beals, R. Coifman, Scattering and inverse scattering for first order systems, *Commun. Pure Appl. Math.* 37 (1984) 39-90.

- [3] M. Borghese, R. Jenkins, K.T.R. McLaughlin, Long-time asymptotic behavior of the focusing nonlinear Schrödinger equation, *Ann. I. H. Poincaré Anal.* 35 (2018) 887-920.
- [4] A. Boutet de Monvel, A. Its, and D. Shepelsky, Painlevé-type asymptotics for the Camassa-Holm equation, *SIAM J. Math. Anal.* 42 (2010) 1854-1873.
- [5] A. Boutet de Monvel, I. Karpenko and D. Shepelsky, A Riemann-Hilbert approach to the modified Camassa-Holm equation with nonzero boundary conditions, *J. Math. Phys.* 61 (2020) 031504.
- [6] A. Boutet de Monvel, A. Kostenko, D. Shepelsky, and G. Teschl, Long-time asymptotics for the Camassa-Holm equation, *SIAM J. Math. Anal.* 41 (2009) 1559-1588.
- [7] A. Boutet de Monvel and D. Shepelsky, Riemann-Hilbert approach for the Camassa-Holm equation on the line, *C. R. Math. Acad. Sci. Paris* 343(10) (2006) 627-632.
- [8] A. Boutet de Monvel and D. Shepelsky, Riemann-Hilbert problem in the inverse scattering for the Camassa-Holm equation on the line, *Probability, geometry and integrable systems*, *Math. Sci. Res. Inst. Publ.*, vol. 55, Cambridge Univ. Press, Cambridge, (2008), 53-75.
- [9] A. Boutet de Monvel and D. Shepelsky, Long-time asymptotics of the Camassa-Holm equation on the line, *Integrable systems and random matrices*, *Contemp. Math.*, vol. 458, Amer. Math. Soc., Providence, RI, (2008), 99-116.
- [10] A. Boutet de Monvel and D. Shepelsky, Long time asymptotics of the Camassa-Holm equation on the half-line, *Ann. Inst. Fourier (Grenoble)* 59 (2009) 3015-3056.
- [11] A. Boutet de Monvel, I. Karpenko and D. Shepelsky, The modified Camassa-Holm equation on a nonzero background: large-time asymptotics for the Cauchy problem, arXiv:2011.13235.
- [12] R. Camassa and D. D. Holm, An integrable shallow water equation with peaked solitons, *Phys. Rev. Lett.* 71(1)(1993) 1661-1664.
- [13] R. Camassa, D. D. Holm, and J. M. Hyman, A new integrable shallow water equation, *Adv. Appl. Mech.* 31(1) (1994) 1-33.
- [14] Q.Y. Cheng, E.G. Fan, Long-time asymptotics for the focusing Fokas-Lenells equation in the solitonic region of space-time, *J. Differ. Equ.* 309 (2022) 883-948.
- [15] X. Chang and J. Szmigielski, Liouville integrability of conservative peakons for a modified CH equation, *J. Nonlinear Math. Phys.* 24 (2017) 584-595.
- [16] R. M. Chen, F. Guo, Y. Liu, and C. Qu, Analysis on the blow-up of solutions to a class of integrable peakon equations, *J. Funct. Anal.* 270 (2016) 2343-2374.
- [17] R. M. Chen, Y. Liu, C. Qu, and S. Zhang, Oscillation-induced blow-up to the modified Camassa-Holm equation with linear dispersion, *Adv. Math.* 272 (2015) 225-251.
- [18] A. Constantin and D. Lannes, The hydrodynamical relevance of the Camassa-Holm and Degasperis-Procesi equations, *Arch. Ration. Mech. Anal.* 192 (2009) 165-186.
- [19] S. Cuccagna, R. Jenkins, On asymptotic stability of N -solitons of the defocusing nonlinear Schrödinger equation, *Commun. Math. Phys.* 343 (2016) 921-969.
- [20] S. Cuccagna, M. Maeda, On weak interaction between a ground state and a non-trapping potential, *J. Differ. Equ.* 256 (2014) 1395-1466.
- [21] S. Cuccagna, P. Pelinovsky, The asymptotic stability of solitons in the cubic NLS equation on the line, *Appl. Anal.* 93 (2014) 791-822.
- [22] X. Zhou, L^2 -Sobolev space bijectivity of the scattering and inverse scattering transforms, *Commun Pure Appl Math.* 51 (1998) 697-731.
- [23] P. Deift, A.R. Its, X. Zhou, Long-time asymptotics for integrable nonlinear wave equations, *springer series in nonlinear dynamics important developments in soliton theory*, page 181-204, 1993.
- [24] P. Deift, S. Kamvissis, T. Kriecherbauer, X. Zhou, The Toda rarefaction problem, *Commun. Pure Appl. Math.* 49(1) (1996) 35-83.
- [25] P. Deift, T. Kriecherbauer, K.T.-R. McLaughlin, S. Venakides, X. Zhou, Strong asymptotics of orthogonal polynomials with respect to exponential weights. *Commun. Pure Appl. Math.* 52(12) (1999) 1491-1552.
- [26] P. Deift, J. Park, Long-time asymptotics for solutions of the NLS equation with a delta potential and even initial data, *Int. Math. Res. Not. IMRN* 24 (2011) 5505-5624.

- [27] P. Deift and X. Zhou, A steepest descend method for oscillatory Riemann-Hilbert problems. Asymptotics for the MKdV equation, *Ann. Math.* 137(2) (1993), 295-368.
- [28] P. Deift, X. Zhou, Long-time asymptotics for integrable systems. Higher order theory, *Commun. Math. Phys.* 165(1) (1994) 175-191.
- [29] P. Deift, X. Zhou, Long-time behavior of the non-focusing nonlinear Schrödinger equation, a case study, *Lectures in Mathematical Sciences, New Ser.*, vol. 5, Graduate School of Mathematical Sciences, University of Tokyo, 1994.
- [30] P. Deift, X. Zhou, Long-time asymptotics for solutions of the NLS equation with initial data in a weighted Sobolev space, *Commun. Pure Appl. Math.* 56 (2003) 1029-1077.
- [31] M. Dieng, K. McLaughlin, Long-time asymptotics for the NLS equation via dbar methods, arXiv:0805.2807.
- [32] Y. Do, A nonlinear stationary phase method for oscillatory Riemann-Hilbert problems, *Int. Math. Res. Not.* 12 (2011) 2650-2765.
- [33] J. Eckhardt, Unique solvability of a coupling problem for entire functions, *Constr. Approx.* 49 (2019) 123-148.
- [34] J. Eckhardt and G. Teschl, On the isospectral problem of the dispersionless Camassa-Holm equation, *Adv. Math.* 235 (2013) 469-495.
- [35] J. Eckhardt and G. Teschl, A coupling problem for entire functions and its application to the long-time asymptotics of integrable wave equations, *Nonlinearity* 29 (2016) 1036-1046.
- [36] A.S. Fokas, On a class of physically important integrable equations, *Phys. D* 87(1-4) (1995) 145-150.
- [37] Y. Fu, G. Gui, Y. Liu, and C. Qu, On the Cauchy problem for the integrable modified Camassa-Holm equation with cubic nonlinearity, *J. Diff. Equ.* 255 (2013) 1905-1938.
- [38] Y. Gao and J.-G. Liu, The modified Camassa-Holm equation in Lagrangian coordinates, *Discrete Contin. Dyn. Syst. Ser. B* 23 (2018) 2545-2592.
- [39] X. Geng, K. Wang, M. Chen, Long-time asymptotics for the spin-1 Gross-Pitaevskii equation, *Commun. Math. Phys.* 382(1) (2021) 585-611.
- [40] G. Gui, Y. Liu, P. J. Olver, and C. Qu, Wave-breaking and peakons for a modified Camassa-Holm equation, *Commun. Math. Phys.* 319 (2013) 731-759.
- [41] Y. Hou, E. Fan, and Z. Qiao, The algebro-geometric solutions for the Fokas-Olver-Rosenau-Qiao (FORQ) hierarchy, *J. Geom. Phys.* 117 (2017), 105-133.
- [42] A.R. Its, Asymptotic behavior of the solutions to the nonlinear Schrödinger equation, and isomonodromic deformations of systems of linear differential equations, *Dokl. Akad. Nauk SSSR* 261(1) (1981) 14-18.
- [43] R. S. Johnson, Camassa-Holm, Korteweg-de Vries and related models for water waves, *J. Fluid Mech.* 455 (2002), 63-82.
- [44] S. Kamvissis, K.T.-R. McLaughlin, P.D. Miller, Semiclassical soliton ensembles for the focusing nonlinear Schrödinger equation, In: *Annals of Math. Studies*, vol. 154, Princeton Un. Press, Princeton (2003).
- [45] H. Krügher, G. Teschl, Long-time asymptotics of the Toda lattice for decaying initial data revisited, *Rev. Math. Phys.* 21 (2009) 61-109.
- [46] Z.Q. Li, S.F. Tian, J.J. Yang, Soliton resolution for the Wadati-Konno-Ichikawa equation with weighted Sobolev initial data, *Annales Henri Poincaré*, 23 (2022), 2611-2655.
- [47] X. Liu, Y. Liu, P. J. Olver, and C. Qu, Orbital stability of peakons for a generalization of the modified Camassa-Holm equation, *Nonlinearity* 27 (2014) 2297-2319.
- [48] X.C. Liu, Y. Liu, C.Z. Qu, Orbital stability of the train of peakons for an integrable modified Camassa-Holm equation, *Adv. Math.* 255 (2014) 1137-1167.
- [49] Y. Liu, P. J. Olver, C. Qu, and S. Zhang, On the blow-up of solutions to the integrable modified Camassa-Holm equation, *Anal. Appl. (Singap.)* 12 (2014) 355-368.
- [50] Y. Martel, Linear problems related to asymptotic stability of solitons of the generalized KdV equations, *SIAM J. Math. Anal.* 38 (2006) 759-781.
- [51] Y. Matsuno, Smooth and singular multisoliton solutions of a modified Camassa-Holm equation with cubic nonlinearity and linear dispersion, *J. Phys. A* 47 (2014) 125203.
- [52] Y. Martel, F. Merle, Asymptotic stability of solitons of the gKdV equations with general nonlinearity, *Math. Ann.* 341 (2008) 391-427.

- [53] K. T. R. McLaughlin, P. D. Miller, The $\bar{\partial}$ steepest descent method and the asymptotic behavior of polynomials orthogonal on the unit circle with fixed and exponentially varying non-analytic weights, *Int. Math. Res. Not.* (2006), Art. ID 48673.
- [54] K. T. R. McLaughlin, P. D. Miller, The $\bar{\partial}$ steepest descent method for orthogonal polynomials on the real line with varying weights, *Int. Math. Res. Not.*, IMRN (2008), Art. ID 075.
- [55] A. V. Mikhailov and V. S. Novikov, Perturbative symmetry approach, *J. Phys. A* 35 (2002) 4775-4790.
- [56] V. Novikov, Generalizations of the Camassa-Holm equation, *J. Phys. A* 42 (2009) 342002.
- [57] P. J. Olver and P. Rosenau, Tri-hamiltonian duality between solitons and solitary-wave solutions having compact support, *Phys. Rev. E* 53 (1996) 1900.
- [58] Z. Qiao, A new integrable equation with cuspons and W/M -shape-peaks solitons, *J. Math. Phys.* 47(11) (2006) 112701.
- [59] C. Qu, X. Liu, and Y. Liu, Stability of peakons for an integrable modified Camassa-Holm equation with cubic nonlinearity, *Commun. Math. Phys.* 322 (2013) 967-997.
- [60] J. Schiff, Zero curvature formulations of dual hierarchies, *J. Math. Phys.* 37 (1996) 1928-1938.
- [61] S. F. Tian, The mixed coupled nonlinear Schrödinger equation on the half-line via the Fokas method, *Proc. R. Soc. Lond. A* 472(2195) (2016) 20160588.
- [62] S. F. Tian, Initial-boundary value problems for the general coupled nonlinear Schrödinger equation on the interval via the Fokas method, *J. Differ. Equ.* 262(1) (2017) 506-558.
- [63] S.F. Tian, T.T. Zhang, Long-time asymptotic behavior for the Gerdjikov-Ivanov type of derivative nonlinear Schrödinger equation with time-periodic boundary condition, *Proc. Am. Math. Soc.* 146 (2018) 1713-1729.
- [64] G. Varzugin, Asymptotics of oscillatory Riemann-Hilbert problems, *J. Math. Phys.* 37 (1996) 5869-5892.
- [65] D.S. Wang, B.L. Guo, X.L. Wang, Long-time asymptotics of the focusing Kundu-Eckhaus equation with nonzero boundary conditions, *J. Differ. Equ.* 266(9) (2019) 5209-5253.
- [66] J. Xu, E.G. Fan, Long-time asymptotics for the Fokas-Lenells equation with decaying initial value problem: Without solitons, *J. Differ. Equ.* 259 (2015) 1098-1148.
- [67] K. Yan, Z. Qiao, and Y. Zhang, On a new two-component b-family peakon system with cubic nonlinearity, *Discrete Contin. Dyn. Syst.* 38 (2018) 5415-5442.
- [68] Y.L. Yang, E.G. Fan, Soliton resolution for the short-pulse equation, *J. Differ. Equ.* 280 (2021) 644-689.
- [69] Y.L. Yang, E.G. Fan, On the long-time asymptotics of the modified Camassa-Holm equation in space-time solitonic regions, *Adv. Math.* 402 (2022) 108340.
- [70] Y.L. Yang, E.G. Fan, Y. Liu, On the global well-posedness for the modified Camassa-Holm equation with a nonzero background, arXiv:2207.12711.

JIN-JIE YANG, SHOU-FU TIAN (CORRESPONDING AUTHOR) AND ZHI-QIANG LI
SCHOOL OF MATHEMATICS, CHINA UNIVERSITY OF MINING AND TECHNOLOGY, XUZHOU 221116, PEOPLE'S REPUBLIC OF CHINA

Email address: sftian@cumt.edu.cn, shoufu2006@126.com (S.F. Tian)