

IoT application using a unique rectangular 2.4GHz microstrip patch antenna

Oahidul Islam

Department of Electrical & Electronic Engineering
Daffodil International University
Dhaka, Bangladesh
oahidul33-832@diu.edu.bd

Sumaya Akter Shikha

Department of Electrical & Electronic Engineering
Daffodil International University
Dhaka, Bangladesh
sumaya33-887@diu.edu.bd

Abstract—Internet of Things (IoT)-based applications must be integrated with wireless communication technologies for this make application data easily accessible. The wireless communication system is a crucial component of IoT infrastructure, serving as a bridge for bidirectional connection for data gathering and control message delivery. In this article, a modified meander form microstrip patch antenna for IoT applications in 2.4 GHz ISM (Industrial, Scientific, and Medical) band is suggested. The suggested antenna has a gain of up to 4.01 dBi and an efficiency of up to 90% directivity up to 7.14. The performance after simulation of this antenna that is combined with a 2.4GHz radio frequency module and IoT sensors. Having small size and high fractional bandwidth which gives a good performance in IoT application. The patch's length width is 30.2 mm, and its length 47mm at a resonance frequency of 2.4 GHz is 38 mm, with a feeding offset position of 6 mm. The substrate has a height of 1.5 mm that appropriate for short-range IoT applications

Index Terms—Internet of thing, wireless communication, Microstrip patch antenna, Wireless applications, Bandwidth

I. INTRODUCTION

IoT Analytics Research that, in 2022 the Internet of Things industry is predicted to expand 18% to 14.4 billion active connections. It is predicted that there will be around 27 billion linked IoT devices by 2025, as supply restrictions ease and demand increases. Increasing the device number as well as researchers confront issues such as device miniaturization. First thing in wireless communication the term antenna come which are developing day by day. Number of IoT device increases as well as there grow up a huge responsibility topics like data transmission rate, network reliability, security issues etc. Technology relates to wireless sensor helping to increase device internet connectivity as well as the effectiveness of IoT application operation [1]. Various field in IoT development like agriculture, medical, security, smart home, tracking devices associated with wireless technology going towards future and here antenna plays an important role. Nowadays, RF energy

harvesting for powering such sensors is a rising subject of study [2]. Acquire desire performance from antenna, different technique followed by the researcher. The transmission of the integrated communication data at a higher frequency occurs in the 2.4 GHz unlicensed industrial, scientific, and medical band. [3] demonstrated a transparent loop antenna for IoT. that antenna can be placed in several locations. Also, MIMO antenna designed in [4] and elaborate how MIMO antenna helps in IoT allocation. MIMO antenna with two ports for 6G/IoT applications. The suggested antenna works in the Terahertz frequency band (e.g., 3.2-3.8 THz) and has high radiation performance [5]. For GPS, Wi-Fi, Bluetooth planner antenna designed with the fractional bandwidth 143% at [6]. Various fractal antenna shapes are explored in [7]. A four-port planar smartphone flexible antenna with four elements for Sub-6 5G and WLAN smart terminals [8]. Different sizes of 2.4 GHz antenna proposed here [9] where it have a good impedance fractional bandwidth.

This paper is about 2.4 GHz antenna for IoT application Using computer simulation technology and MATLAB script using for the simulation. Following this portion of introduction, section 2 highlights the suggested antenna design parameters, calculations, and optimization. Section 3 includes results & discussion for the antenna's performance. Section 4 has the conclusion. The goal of this study is to address the growing need for wireless communication in a variety of applications. By this proposal paper works going on,

- a. Increase an antenna's bandwidth
- b. Antenna gain improvement

II. Antenna Design

The suggested antenna geometry includes a dielectric substrate, a patch, and a microstrip feed line. A microstrip patch antenna is made up of a radiating patch on one side of a dielectric substrate and a ground plane

on the other. [10] Figure 1 shows one example of this. It has a dielectric substrate (FR-4), a patch, and a ground plane.

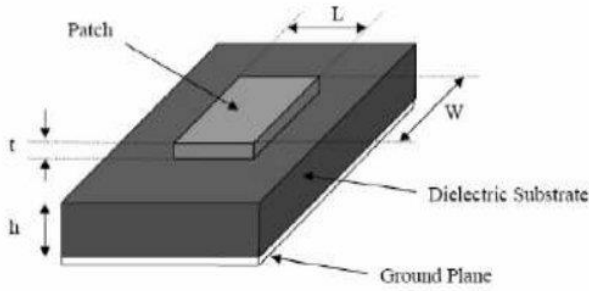

Figure 1. Microstrip Patch Antenna with structure [10]

Computed with a fixed operating frequency of 2 GHz to 2.8 GHz in the rectangular patch antenna having a substrate height of 1.6 mm, varied dielectric permittivity of substrates, and a speed of light of $c = 3 \cdot 10^8$ m/s, as stated in Table 1 and utilizing the following processes [11].

Table:1 Antenna design dimension

Parameters	Values (mm)
Substrate length	47,04
Substrate width	38.48
Substrate height	1.5
Patch length	30.58
Patch width	39.19
Feedline length	5.2
Feedline width	1.0
Dielectric constant	4.08

Calculation model for antenna,

Step:1

Patch width calculation below,

$$W = \frac{c}{2f} \sqrt{\frac{2}{\epsilon_r + 1}} \quad (1)$$

Step:2

Dielectric constant calculation

$$\epsilon_{reff} = \frac{\epsilon_r + 1}{2} + \frac{\epsilon_r - 1}{2} \left[1 + 12 \frac{w}{h} \right]^{-1/2} \quad (2)$$

Step:3

Calculate effective length,

$$L_{eff} = \frac{c}{2f \sqrt{\epsilon_{reff}}} \quad (3)$$

Step:4

Normalized extension of length,

$$\Delta L = 0.412h \frac{(\epsilon_{reff} + 0.3) \left(\frac{w}{h} + 0.264 \right)}{(\epsilon_{reff} - 0.258) \left(\frac{w}{h} + 0.8 \right)} \quad (4)$$

Step:5

Length of the patch,

$$L = L_{eff} - 2\Delta L \quad (5)$$

Step:6

Ground plane width calculation,

$$W_g = W + 6h \quad (6)$$

Step:7

Ground length calculation,

$$L_g = L + 6h \quad (7)$$

Step:8

Antenna Efficiency,

$$= \frac{P_{rad}}{P_T} * 100\% \quad (8)$$

The feed point must be placed on a plot of land. The solution frequency, or resonance frequency, is 2.4GHz, while the operational frequency is set to be between 1.5 and 5.0 GHz.

Based on the data above, one may conclude that a substrate with a low dielectric constant result in a bigger antenna size. As a result, for the microstrip antenna design, a substrate with a higher dielectric constant is used.

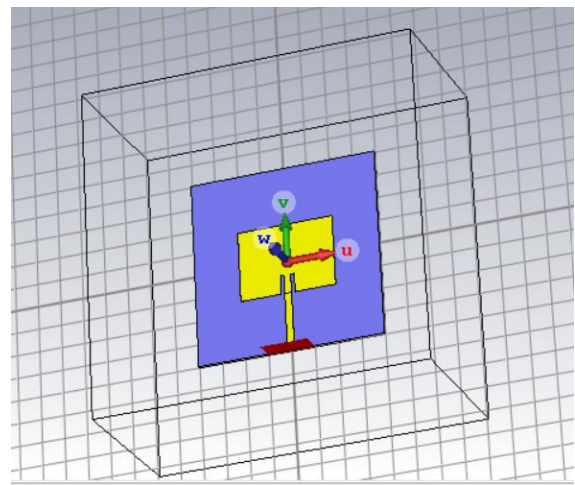

Figure 2: CST-designed microstrip patch antenna

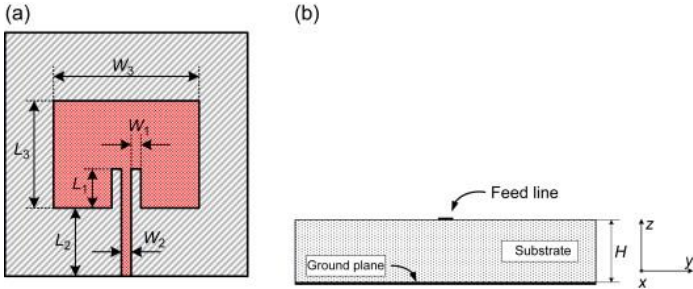

Figure 3: Microstrip patch antenna dimension

Following figure 3 gives the complete idea about patch antenna. Where it's easier to define substrate height, length, feed line so on. Using computer simulation technology patch antenna design dimension identified. Also using online platform to collect the important calculation related to antenna.

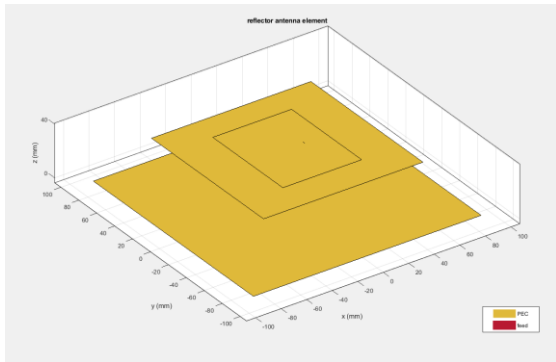

Figure 3: Microstrip patch antenna in MATLAB

Using MATLAB toolbox antenna designed. Also using MATLAB script file it's easier to design microstrip patch antenna.

III. Results and Discussion

To create and stimulate the findings, Computer Simulation Technology CST software with a license is utilized. This version is chosen since it is available at the university. The simulation results displayed are for the suggested design which was created using a FR-4 substrate.

The simulated results of the suggested antenna design are shown in Figure:4. The acquired values are in the optimal dimensions utilizing a FR-4 substrate. Return loss, VSWR, gain, directivity, and radiation pattern are some of the words used.

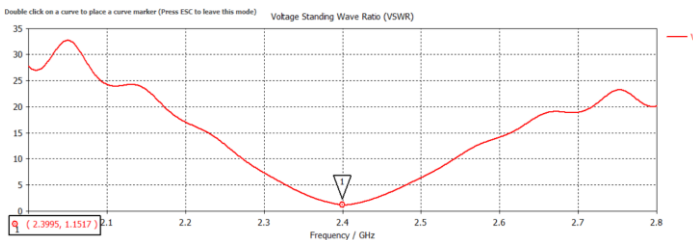

Figure 4 Voltage standing wave ratio (VSWR)

In figure 4 antenna voltage standing wave ratio is near to 1.15 it means It is a measure of how efficiently RF power is delivered from the power source to the load through a transmission line. For 2.5 GHz value of VSWR is 6.57 and for 2.8 GHz it is 20.04.

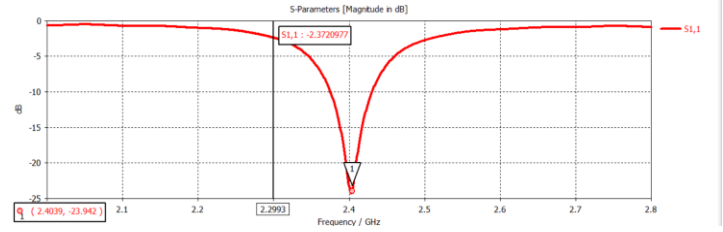

Figure 5 Return loss in proposed antenna

For this proposed antenna, return loss is -23.942 dB where as at 2.5 GHz return loss is -2.75dB. For 2.8 GHz return loss is -0.867 dB.

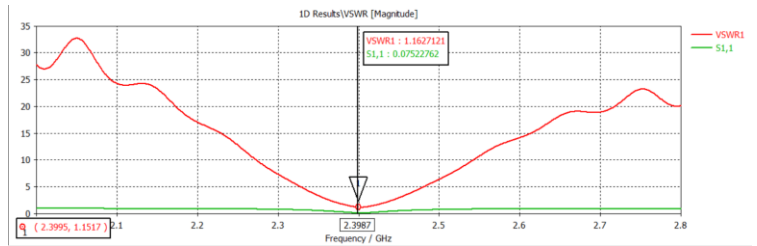

Figure:6 Return loss vs VSWR curve

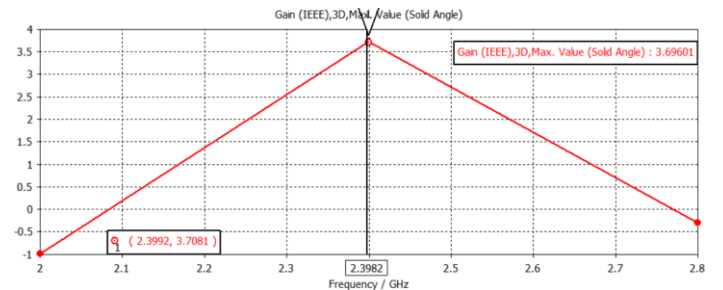

Figure:7. Proposed Antenna gain

In this figure 7 proposed antenna gain for 2.399 GHz is 3.70 dB. Also, for 2.5 GHz and 2.8 GHz antenna gains are 2.71 and -0.30 dB respectively. An antenna's gain reflects how successfully it transforms radio waves into electrical signals or vice versa. So, for proposed antenna 2.4 GHz in IoT application easily handle it.

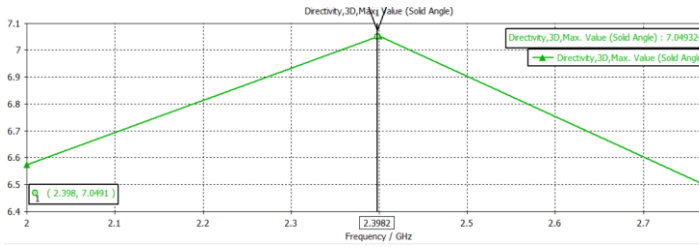

Figure:8. Proposed Antenna directivity

For proposed antenna design 2.4 GHz we get antenna directivity 7.049 dB. Also, for 2.5 GHz and 2.8 GHz antenna directivity are 6.90 and 6.45 dB respectively. The stronger the directivity, the more concentrated or focused the beam generated by an antenna.

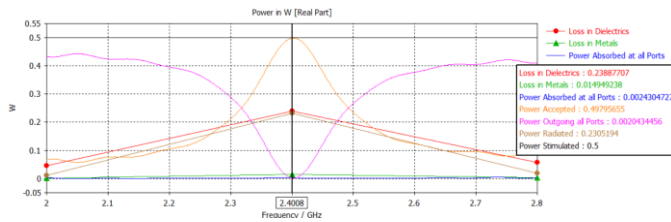

Figure:9. Proposed Antenna power

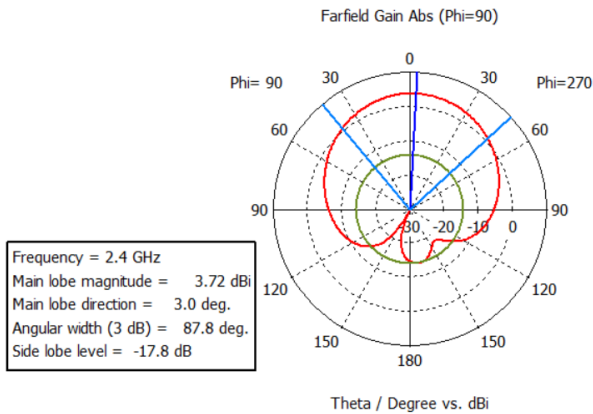
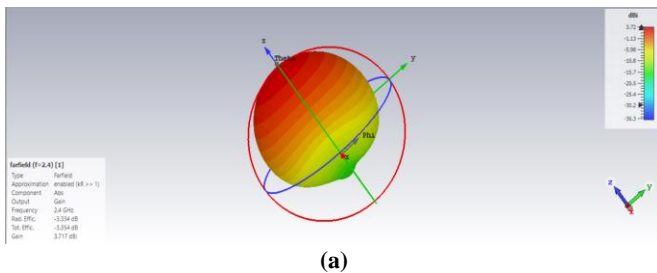
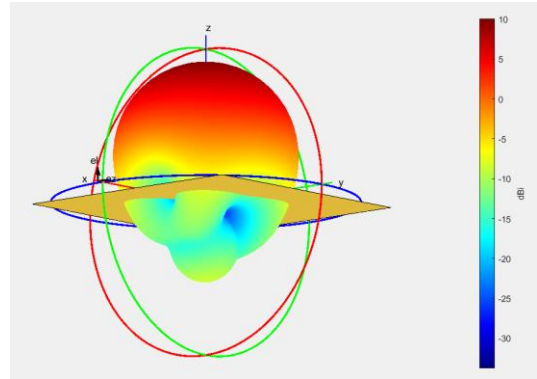

Figure:10. Radiation pattern of proposed antenna FR-4 Substrate



(a)



(b)

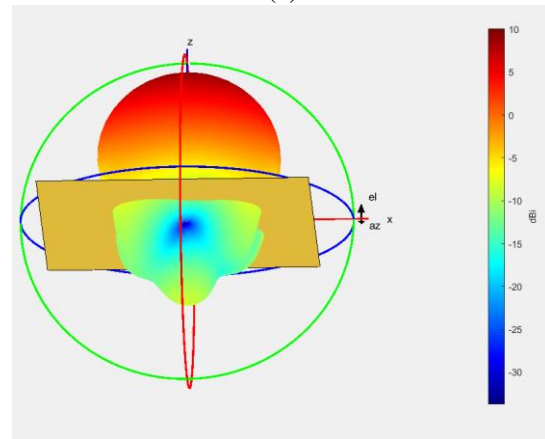

(c)

Figure:11. 3D polar gain proposed antenna (a), (b), (c)

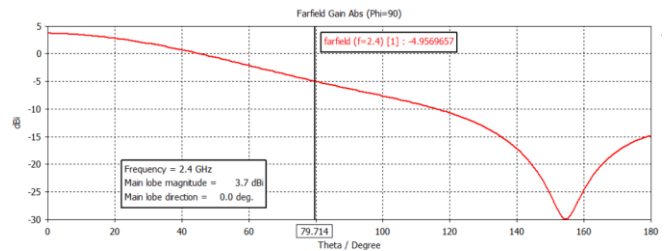

Figure:12. Far field density

The computation of the emission of electromagnetic radiation within a particular wavelength is known as far field density. As illustrated in Figure 12, metrics such as far-field electric component, far-field magnetic component, and power density may be used to identify wavelength emission.

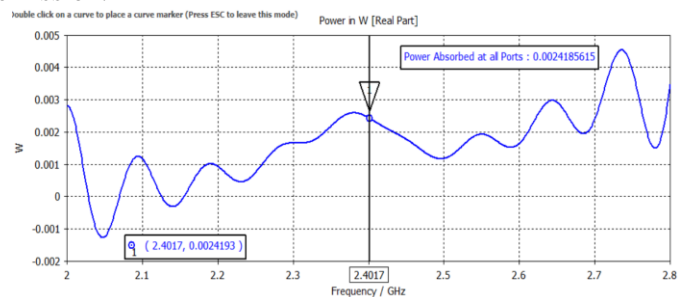

Figure:13. Power absorbed at all port

The radiated energy of an antenna is represented as power. It is used to supply power to an antenna. Then, as seen in Figure 13, we may transmit signals to the receiver.

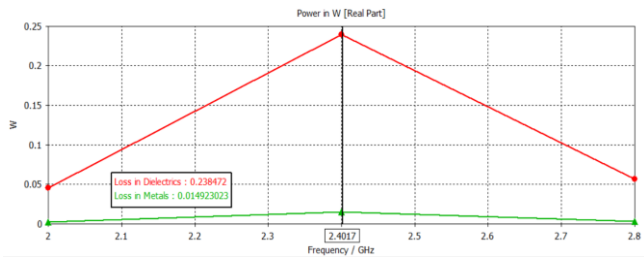

Figure:14. Material loss in proposed antenna

Figure 14 depicts the antenna's dielectric losses. Dielectric loss happens as a result of the dielectric material's conductivity. As a result, it turns energy into heat in the antenna. For 2.4 GHz antenna dielectric power loss is 0.23 W. Its good loss is very low. For other material loss its os 0.0149 watt.

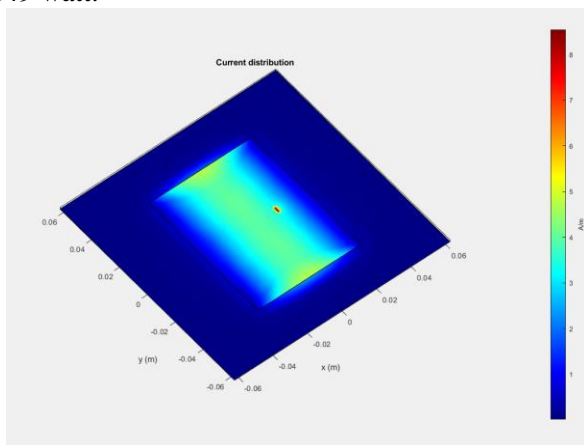

Figure:15. Current distribution proposed antenna

Using MATLAB antenna design tool for proposed

antenna 2.4 GHz current distribution figure 15 shows.

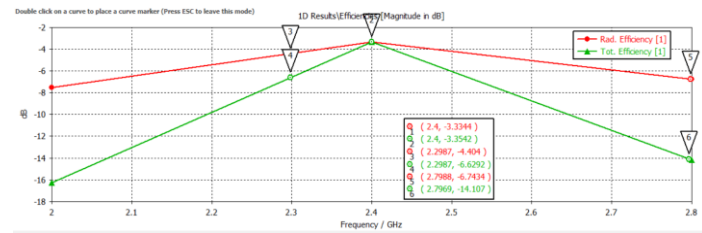

Figure:16. Efficiency of proposed antenna

For this proposed antenna efficiency of total and radiated find out through this graphical view. Also, for 2.3 and 2.8 GHz respectively its easier to identify the efficiency and compare them.

IV. CONCLUSION

This study describes the design and modeling of rectangular microstrip patch antennas for operation at 2.4 GHz. CST Studio and MATLAB antenna design tools are used to calculate performance metrics like as VSWR, return loss, gain, and directivity. According to the results, the resonant frequency is 2.4 GHz, and the return loss is -23.942 dB. The total gain of the antenna is 3.7174dB at frequency 2.4 GHz. This antenna is mostly used in WLAN applications such as WIFI, Bluetooth, and IoT [12]. The future work would include gain that boosts the emitted signal while using no extra battery power, providing reasonably continuous signal transmission in all directions for IoT items so that connectivity is not disrupted by movement, constructing the antenna and testing the findings in a real-world setting. Also, antenna's low gain, limited bandwidth, low efficiency, and low power must all be considered.

V. REFERENCES

- [1] Shahidul Islam, M., Islam, M. T., Almutairi, A. F., Beng, G. K., Misran, N., & Amin, N. (2019). Monitoring of the human body signal through the internet of things (IOT) based Lora Wireless Network System. *Applied Sciences*, 9(9), 1884. <https://doi.org/10.3390/app9091884>
- [2] Chindhi, P. S. (2020). Characteristics mode analysis of modified inset-fed microstrip antenna for radio frequency energy harvesting. *Bioscience Biotechnology Research Communications*, 13(13), 171–176. <https://doi.org/10.21786/bbrc/13.13/24>
- [3] Koga, Y., & Kai, M. (2018). A transparent double folded loop antenna for IOT Applications. *2018 IEEE-APS Topical Conference on Antennas and Propagation in Wireless Communications (APWC)*. <https://doi.org/10.1109/apwc.2018.8503801>
- [4] Jha, K. R., Bukhari, B., Singh, C., Mishra, G., & Sharma, S. K. (2018). Compact planar multistandard MIMO antenna for IOT Applications. *IEEE Transactions on Antennas and Propagation*, 66(7), 3327–3336. <https://doi.org/10.1109/tap.2018.2829533>
- [5] Khaleel, S. A., Hamad, E. K., Parchin, N. O., & Saleh, M. B. (2022). MTM-inspired graphene-based thz MIMO antenna configurations using

- characteristic mode analysis for 6G/IOT Applications. *Electronics*, *11*(14), 2152. <https://doi.org/10.3390/electronics11142152>
- [6] Alibakhshikenari, M., Limiti, E., Naser-Moghadasi, M., Virdee, B. S., & Sadeghzadeh, R. A. (2017). A new wideband planar antenna with band-notch functionality at GPS, Bluetooth and WIFI bands for integration in Portable Wireless Systems. *AEU - International Journal of Electronics and Communications*, *72*, 79–85. <https://doi.org/10.1016/j.aeue.2016.11.023>
- [7] Sharma, N., & Bhatia, S. S. (2021). Comparative analysis of hybrid fractal antennas: A Review. *International Journal of RF and Microwave Computer-Aided Engineering*, *31*(9). <https://doi.org/10.1002/mmce.22762>
- [8] Kulkarni, J., Alharbi, A. G., Desai, A., Sim, C.-Y.-D., & Poddar, A. (2021). Design and analysis of wideband flexible self-isolating MIMO antennas for sub-6 ghz 5G and WLAN smartphone terminals. *Electronics*, *10*(23), 3031. <https://doi.org/10.3390/electronics10233031>
- [9] C. C. Hsu, H. H. Song, Design, Fabrication, and Characterization of a Dual-BandElectrically Small Meander-line Monopole Antenna for Wireless Communications, *International Journal of Electromagnetics and Applications*, Vol. 3 No. 2, 2013, pp. 27-34. doi: 10.5923/j.ijea.20130302.04.
- [10] Kashyap, S. (2015). Design and optimization of planar antenna for ISM band(2.4 ghz) applications. *International Journal of Advance Engineering and Research Development*, *2*(04). <https://doi.org/10.21090/ijaerd.02049>
- [11] Garg, R., Bhartia, P., Bahl, I. J., & Ittipiboon, A. (2001). *Microstrip antenna design handbook*. Artech house.
- [12] Trinh-Van, S., Lee, J. M., Yang, Y., Lee, K.-Y., & Hwang, K. C. (2019). A sidelobe-reduced, four-beam array antenna fed by a modified 4×4 butler matrix for 5G applications. *IEEE Transactions on Antennas and Propagation*, *67*(7), 4528–4536. <https://doi.org/10.1109/tap.2019.290578>