

Touring the Hagedorn Ridge

J.L.F. BARBÓN

*Department of Physics, Theory Division, CERN
CH-1211 Geneva 23, Switzerland
barbon@cern.ch*

E. RABINOVICI

*Racah Institute of Physics, The Hebrew University
Jerusalem 91904, Israel
eliezer@vms.huji.ac.il*

Abstract

We review aspects of the Hagedorn regime in critical string theories, from basic facts about the ideal gas approximation to the proposal of a global picture inspired by general ideas of holography. It was suggested that the condensation of thermal winding modes triggers a first-order phase transition. We propose, by an Euclidean analogue of the string/black hole correspondence principle, that the transition is actually related to a topology change in spacetime. Similar phase transitions induced by unstable winding modes can be studied in toy models. There, using T-duality of supersymmetric cycles, one can identify a topology change of the Gregory–Laflamme type, which we associate with large- N phase transitions of Yang–Mills theories on tori. This essay is dedicated to the memory of Ian Kogan.

1 Introduction

Perturbative string theory manifests several bounds. One of them is a seemingly upper bound on the allowed value of the temperature of a string gas –the Hagedorn temperature [1, 5]. Bounds are there to be understood and challenged. Ian has challenged this one and has taken a peek beyond it in his seminal 1987 work [2]. In this essay we return to discuss the possible instabilities and tachyons emerging near the Hagedorn temperature. We do it equipped with tools that Ian has forged in collaboration with us [22, 7, 8].

The spectrum of a finite-tension critical string in perturbation theory has two universal components: the first is familiar from point particles, it consists of a finite set of massless modes that include gauge fields (open strings) and gravitons (closed strings); the second is of a stringy nature and consists of an exponential degeneracy of states at a given high energy. It is the second component that gives rise to a limiting temperature. For a single string of energy ε the density of states grows very roughly as $\omega(\varepsilon) \sim \exp(\beta_s \varepsilon)$, where $\beta_s \sim \ell_s$ is of the order of the string length scale (we set $\ell_s = 1$ in the following and measure all dimensionful quantities in string units). Its entropy is

$$S(\varepsilon) = \log \omega(\varepsilon) \sim \beta_s \varepsilon, \quad (1.1)$$

and its effective temperature is obtained through the relation

$$\frac{1}{T} = \frac{\partial S}{\partial \varepsilon} \sim \beta_s. \quad (1.2)$$

We see that this temperature is approximately bounded by the constant $T_s = 1/\beta_s$, called the Hagedorn temperature. Essentially all the energy pumped into the system is utilized to create the large number of new particles becoming available as the energy increases, instead of increasing the energy of the particles already present at lower energy. Thus keeping the temperature fixed.

Field-theoretical entropies, such as those of each of the massless modes, scale in d spatial dimensions as $E^{d/(d+1)}$. Hence, the highly excited strings dominate any thermal state beyond string-scale energy densities. Since the entropy is approximately independent of the energy, the resulting specific heat seems infinite. In fact it turns out that small corrections to (1.1) can drive the system either into a stable phase of positive specific heat or to an unstable one of negative specific heat.

A limiting temperature was detected in several types of systems. Historically, it was first observed in the dual theory of hadrons and the first physical interpretation of Hagedorn’s “limiting temperature” was offered in the QCD theory of hadrons. The answer in QCD is certainly dramatic: it was suggested that instead of being an actual limiting temperature its presence suggests a change in the relevant degrees of freedom in terms of which the system is relatively simple. A change resulting in a phase transition from composite objects to their constituents [3, 4]. The Hagedorn temperature in hadronic systems is related to a “deconfinement” transition in which the hadrons liberate their quark-gluon constituents. Once the degrees of freedom are expressed in terms of the field theory of quarks and gluons there is no bound on the temperature; it can be raised indefinitely. This QCD analogy has been a recurrent theme when thinking about the “fundamental strings” of quantum gravity and their possible “true constituents”. This was the problem Ian tackled. The advent of the AdS/CFT correspondence [27] has made specific models amendable to a non-perturbative analysis, allowing to reformulate (and sometimes answer) these old questions. By a twist, a physical picture arises that resembles QCD very closely, and links to gravity and ten-dimensional physics by the magic of holography [9].

We start this essay in section 2 by introducing, in order of appearance, the cast of degrees of freedom relevant for each appropriate energy scale. We paint with large brush strokes the dependence of the temperature on the energy of each set of degrees of freedom, and we find that the system crosses the limiting temperature protected by a black hole armor. In section 3 we review the more detailed high energy behavior of the spectra of various types of strings. This is illustrated using a simple and useful geometrical picture: that of random walks. Particular attention is paid to the dependence of the spectra on the large-distance properties of the background geometry. In sections 4 and 5 an Euclidean picture of the physics around the Hagedorn temperature is discussed. The physical significance of the thermal tachyon discovered by Ian is addressed, and its stringy features are underscored. The conclusion that this tachyon seems to be more of a book keeping device than a physical particle is deconstructed. Instead, a very physical Euclidean picture emerges; the transition monitors a change in the topology of spacetime enforced by the nucleation of black holes. The manifestation of the tachyon is a specialization of the mechanism envisaged by Ian. We finish in section 6 with a discussion of a toy model in which T-duality goes a long way towards solving a similar problem, involving a dynamical topology change.

This review is centered around the system of ten-dimensional critical strings at finite temperature. Generalizations of these questions to more exotic backgrounds of particular interest, such as LST [10] and PP waves [11], have emerged recently. We will not discuss these issues here, and the interested reader may consult [12] and [13] for results and lists of references.

2 String thermodynamics: the big picture

The first two characters in the cast of constituent ingredients, out of which the gravity cocktail is composed, are the massless modes with field-theoretical entropy of order $E^{d/(d+1)}$ and the highly-excited strings with entropy proportional to their energy. Here we are assuming that the spatial volume, V , is finite, the string coupling is sufficiently small, $g_s \ll 1$, and the local spacetime geometry is approximately flat \mathbf{R}^{d+1} over the length scales of the box of volume $V = L^d$. The simplest string background with these properties is a spatial toroidal compactification with d dimensions of size L , $9 - d$ dimensions of string-scale size, and a very small string coupling, so that we can measure energies with respect to the flat time coordinate, at least to the extent that gravitational back reaction can be neglected. Maximizing the entropy at a given total energy among these two components, one finds the temperature dependence on the energy, $T(E) = (\partial S / \partial E)^{-1}$. This is shown in figure 1.

In this approximation, a temperature plateau seems to emerge. Moreover, the “Hagedorn band” is not sensitive to the number distribution of strings, i.e. the result is the same whether we assume that a single string carries all the available energy, or rather the energy is distributed among various strings (provided all of them carry enough excitation energy to be in the Hagedorn regime).

Corrections to this rough picture depend on the details of the interactions. This is a characteristically difficult problem, since we are in a regime with large breaking of supersymmetry where no standard approximations are available. For the case $d > 2$, a qualitative picture confirms what is expected from the principle of “asymptotic darkness” [6], which states that black holes dominate the extreme high-energy regime of theories that incorporate gravity (in three spacetime dimensions or less, “asymptotic darkness” arguments require special care, since local-

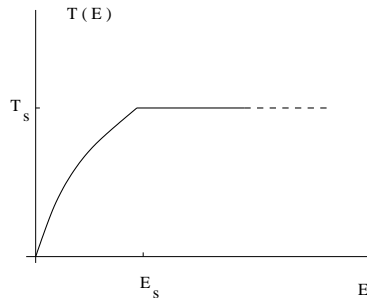

Figure 1: The microcanonical temperature function $T(E) = (\partial S/\partial E)^{-1}$ for a string gas in the two-component approximation. For energies $0 < E < E_s$ below the string-scale threshold, with $E_s = \rho_s V$, and $\rho_s = O(1)$ in string units, the temperature grows as $T \sim E^{1/(d+1)}$, dominated by the massless modes. It gets saturated at $T \approx T_s$ by the highly excited strings. The dotted line represents the sensitivity to small interaction effects that can perturb the Hagedorn plateau either way, into a regime of positive specific heat (with $dT(E)/dE > 0$) or a negative one.

ized energy sources affect asymptotic conditions for the vacuum). String theory is no exception in this regard, having its own correspondence principle [25, 28, 29]. In particular, the entropy of Schwarzschild black holes in d dimensions scales as

$$S \sim E (g_s^2 E)^{\frac{1}{d-2}},$$

and eventually dominates over the Hagedorn degeneracy for $g_s^2 E > 1$. At this point the Hagedorn plateau must end and drop to lower temperatures $T(E) \sim E^{1/(2-d)}$, which is a phase of negative specific heat for $d > 2$. In fact, this phase cannot be continued to arbitrarily high energies because the black hole eventually grows to the size of the box. This threshold coincides with the Jeans length entering inside the box, and corresponds to an energy

$$E_L \sim \frac{L^{d-2}}{g_s^2}. \quad (2.3)$$

The bound $E < E_L$ implies that no thermodynamic limit (large volume with constant energy density) is possible in these systems, since $E_L/V \rightarrow 0$.

An exit out of this tight corner is provided by an appropriate infrared regularization. An interesting model for a “box” is obtained by replacing flat space by Anti-de Sitter space, AdS_{d+1} (c.f. [44]). Consistent string backgrounds exist with AdS factors, the simplest one being the extensively studied $\text{AdS}_5 \times \mathbf{S}^5$ background of type IIB strings. In such a space, the gravitational redshift effectively confines finite-energy excitations within a distance of order R , the radius of negative curvature. Black holes larger than R exist but have new features, the most important being their positive specific heat. The Bekenstein–Hawking entropy of these black holes scales as

$$S \sim (ER)^{\frac{d-1}{d}}, \quad (2.4)$$

exactly like a conformal field theory (CFT) in a $(d-1)$ -dimensional box of size R . One may attempt to consider this as an embodiment of “asymptotic darkness”: a string system whose black holes have only a field-theory type entropy will not be able to possess more than field-theory entropy at high energies. Assuming that the cast of characters is complete, we can draw a global

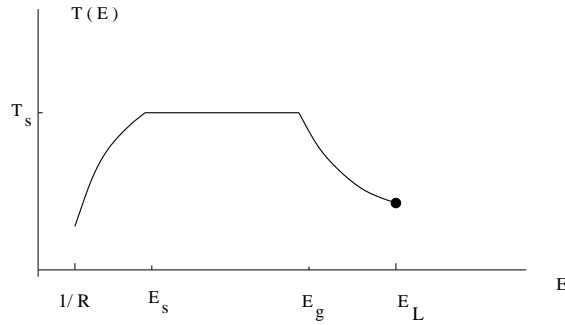

Figure 2: *The temperature function in the three-component approximation. Black hole dominance of the density of states at very high energies implies a phase of negative specific heat, starting at $E_g \sim 1/g_s^2$ (in string units), corresponding to the nucleation of small black holes of size ℓ_s , that subsequently grow as the temperature drops. The Jeans energy $E_L \sim L^{d-2}/g_s^2$ represents the limit beyond which back-reaction effects cannot be neglected on the scale L at the finite-volume box. We have also included the low-energy cutoff at energies of order $1/L$ because the standard scaling $T \sim E^{1/(d+1)}$ only applies for energies above the gap of finite-volume excitations.*

phase diagram, as in figure 3, that sums up our general knowledge of the Hagedorn regime in critical string theory [7, 47, 31, 26].

We see that the standard ten-dimensional Hagedorn phase is always a bounded transient, to be exited at high energies by a black hole phase. If the string coupling is too large, for a given ratio R/ℓ_s , the Hagedorn plateau is not even present, as the black holes form and drop the temperature before reaching T_s . On the other hand, at very weak coupling, $g_s < 1/N$, one has $R < \ell_s$ and the ten-dimensional spacetime is strongly curved. In this case it is better to describe the system in dual Yang–Mills variables. The large black hole goes over the quark-gluon plasma phase, whereas the ten-dimensional Hagedorn regime goes over the four-dimensional glueball regime (thus we are back to the dual models). In this situation, the fate of the Hagedorn plateau must be analyzed in Yang–Mills perturbation theory [34] (c.f. figure 5).

We can draw the microcanonical temperature function by cutting the phase diagram at fixed string coupling, within the limits $N^{-1} < g_s < N^{-9/17}$. The new branch of AdS black holes allows to extend the function $T(E)$ beyond the Jeans energy to indefinite energies [45, 47]. The temperature also rises indefinitely, as shown in figure 4. Actually one can read off figure 4 the phase structure of the system as a function of the temperature. It has a first-order phase transition with a latent heat of $O(g_s^{-2})$ and a critical temperature $T_c \sim 1/R$. In this case, a large black hole nucleates much before the temperature can reach the Hagedorn domain. Thus, the Hagedorn regime is a superheated phase which is either unstable or weakly metastable to decay into the large black hole phase, which engulfs all the space occupied by the hot string gas.

In the larger picture that we are describing, the details of the Hagedorn plateau at weak coupling are not very important. The Hagedorn temperature is approximately maximal, and only accessible by means of superheated states. However, in situations where the string coupling can be taken very small at fixed ℓ_s , the Hagedorn transient can be enlarged, and it is interesting to work out the finer details of the hot string gas. In figures 6 and 7 we depict the two main qualitative scenarios, corresponding to a weakly metastable Hagedorn phase and a locally unstable Hagedorn phase, respectively. It turns out that boundary conditions and finite-size effects

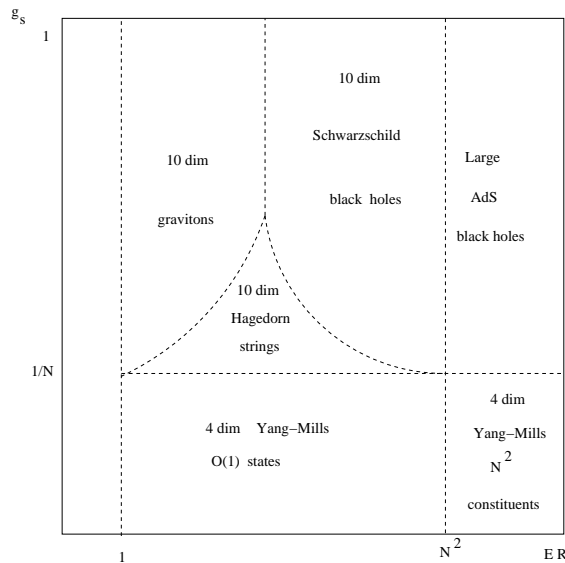

Figure 3: *The phase diagram of quantum gravity in $\text{AdS}_5 \times \mathbf{S}^5$ with N units of Ramond–Ramond flux, according to the AdS/CFT correspondence. A ten-dimensional weakly-curved description only arises for $R/\ell_s \sim (g_s N)^{1/4} \gg 1$. In this case, the Hagedorn regime is bounded by black hole and massless graviton phases. It only exists for sufficiently weak string coupling, $g_s \ll N^{-9/17}$. At very weak couplings, $g_s < 1/N$, one must use four-dimensional descriptions based on the Yang–Mills degrees of freedom, whereas at strong coupling, $g_s > 1$, the diagram mirrors itself by the action of S -duality.*

start playing an important role even in the ideal gas approximation. This is not very surprising, since highly excited strings are “long”, macroscopic states, that are sensitive to the large-scale structure of spacetime. This form of UV/IR connection is the source of many subtleties in string thermodynamics. Some of them will be described in the following section.

3 Ideal gas of long strings

In this section we review, in rather picturesque manner, some well-known features of string thermodynamics in the free approximation. We start by introducing an intuitive geometrical picture for a highly excited string as a random walk in target space. The large entropy factor corresponding to the shape of the random walk in space explains why highly energetic strings dominate the thermodynamics in spite of their large energy. In addition, the random walk picture becomes very convenient to calculate and interpret the leading corrections to (1.1). In the approximation of free strings, these corrections are determined by finite-size effects.

3.1 Random Walks

Consider a highly excited closed string represented as a random walk in target space. The energy ε of the string is proportional to the length of the random walk. The number of those with a fixed starting point thus grows as $\exp(\beta_s \varepsilon)$, explaining the bulk of the entropy of highly energetic strings. Since the walk must close on itself, this overcounts by a factor of roughly the

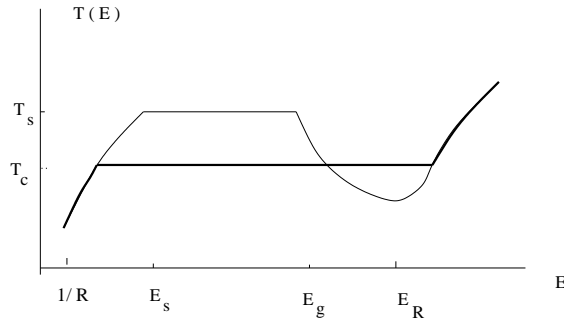

Figure 4: *The complete microcanonical temperature function for thermal AdS spaces, in the four-component approximation. In addition to the gravitons, heavy strings and small black holes, we now include large AdS black holes. When small Schwarzschild black holes grow to size R , at energies $E_R \sim N^2/R$, their specific heat becomes positive and the temperature can grow without bound with $T \sim E^{1/d}$, corresponding to the dual CFT in d dimensions. A Maxwell construction (in the thick line) shows that the Hagedorn plateau is only accessible to superheated states. A first-order phase transition at $T_c \sim 1/R$ nucleates very large black holes of mass $M \sim N^2 R^3 T_c^4$, directly out of the massless graviton phase.*

volume of the walk, denoted $V_{\text{walk}} = W$. Finally, there is a factor of $V = L^d$ from the global translation of the walk in a volume V , and a factor of $1/\varepsilon$ because any point in the string can be a starting point. The final result is

$$\omega_{cl}(\varepsilon) \sim V \cdot \frac{1}{\varepsilon} \cdot \frac{e^{\beta_s \varepsilon}}{W(\varepsilon)}. \quad (3.5)$$

There are two characteristic limiting cases. The volume of the walk is of order $\varepsilon^{d/2}$ when it is well-contained in d spatial dimensions (this corresponds to $L \gg \sqrt{\varepsilon}$), whereas it saturates at order V when it is space-filling ($L \ll \sqrt{\varepsilon}$). Hence, we find a density of states per unit volume

$$\omega_{cl}(\varepsilon)/V \sim \frac{e^{\beta_s \varepsilon}}{\varepsilon^{1+d/2}} \quad (3.6)$$

in d non-compact dimensions, and

$$\omega_{cl}(\varepsilon) = \frac{e^{\beta_s \varepsilon}}{\varepsilon} \quad (3.7)$$

in a compact space that contains completely the highly-excited string states. In this case the formula (3.7) gives the exact leading term of the density of states, including the proportionality constant.

The random walk picture is very geometrical and general. For example, it shows that these densities are largely independent of spacetime topology and only depend on the degree of “containment” of the random walk on the available volume.

As an example of its generality, we can also derive the corresponding entropies for highly excited open strings in a standard Dp - Dq sector. In this case, we have the same leading exponential degeneracy for random walks with a fixed starting point on the Dp -brane. Fixing the endpoint of a particular point of the Dq -brane divides by a factor of the total random walk

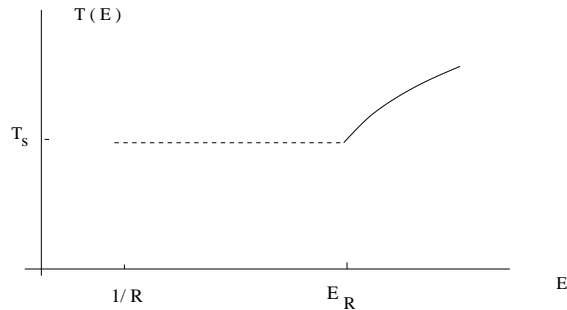

Figure 5: At very weak coupling $g_s \sim 1/N$, the system matches the perturbative regime of Yang–Mills theory and several hierarchical windows of the system shut down. The ten-dimensional description becomes strongly coupled and standard geometrical intuition breaks down. The string energy E_s that signals the beginning of the Hagedorn plateau becomes of the same order as the finite-size gap of the gauge theory $E_{\text{gap}} \sim 1/R$, so that the phase of ten-dimensional graviton entropy disappears. The plateau ends at $E_R \sim N^2/R$, the energy of the phase transition into the Yang–Mills plasma. This threshold coincides with E_g , and the phase of ten-dimensional black holes with negative specific heat also disappears. Instead, the details of the plateau must be worked out in Yang–Mills perturbation theory in the 't Hooft coupling $g_s N < 1$, where some “precursors” of the strong-coupling behaviour described in Fig 4 can be identified (c.f. [34]).

volume W . Since endpoints can move in the part of each brane occupied by the walk, we have a further degeneracy factor

$$(W_{\text{NN}}W_{\text{ND}}) \cdot (W_{\text{NN}}W_{\text{DN}}),$$

where N and D refer to Neumann and Dirichlet boundary conditions. Finally, the overall translation of the walk in the excluded NN volume gives a factor $V_{\text{NN}}/W_{\text{NN}}$. The final result is

$$\omega_{op}(\varepsilon) \sim \frac{V_{\text{NN}}}{W_{\text{NN}}} \cdot W_{\text{NN+ND}} \cdot W_{\text{NN+DN}} \cdot \frac{e^{\beta_s \varepsilon}}{W} \sim \frac{V_{\text{NN}}}{W_{\text{DD}}} e^{\beta_s \varepsilon}. \quad (3.8)$$

We see that the density of states is only sensitive to the volume of the random walk in the DD directions. Again, we have two qualitatively limiting cases: if the random walk is well-contained in the d_{\perp} directions with DD boundary conditions we have $L_{\text{DD}} = L_{\perp} \gg \sqrt{\varepsilon}$ and $W_{\text{DD}} \sim \varepsilon^{d_{\perp}/2}$ so that

$$\omega_{op}(\varepsilon)/V_{\text{NN}} \sim \frac{e^{\beta_s \varepsilon}}{\varepsilon^{d_{\perp}/2}}. \quad (3.9)$$

On the other hand, if the walk is filling the DD volume we find

$$\omega_{op}(\varepsilon)/V_{\text{NN}} \sim \frac{e^{\beta_s \varepsilon}}{V_{\text{DD}}}. \quad (3.10)$$

These densities can also be obtained as equilibrium distributions that solve Boltzman equations for interacting random walks (c.f. [17]). We may summarize the results by the parametrization

$$\omega(\varepsilon) \sim f \cdot \frac{e^{\beta_s \varepsilon}}{\varepsilon^{1+\gamma}}, \quad (3.11)$$

where $f = V_{\parallel}/V_{\perp}$. Here V_{\parallel} is the volume available to the center of mass motion of the walk and V_{\perp} is the transverse volume in DD directions (we set $V_{\perp} = 1$ in string units when the

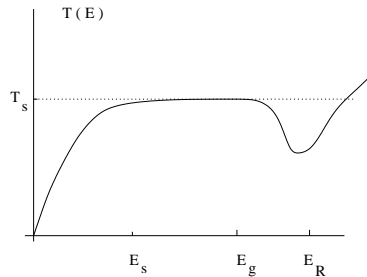

Figure 6: *The fine structure of a weakly metastable Hagedorn plateau. The Hagedorn temperature T_s is strictly limiting in this region and the specific heat on the approximate plateau is large and positive, becoming locally unstable for $E > E_g$. Finite-size effects imply this type of behavior for an ideal gas of closed strings.*

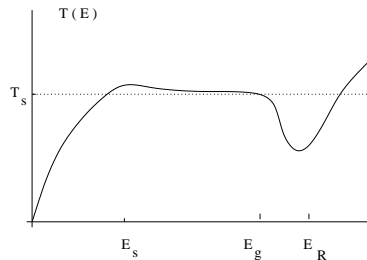

Figure 7: *The fine structure of a locally unstable Hagedorn plateau. In this case T_s is first crossed at $E \sim E_s$ and then approached from above in the regime $E_s \ll E \ll E_g$. Local instability sets in at $E \sim E_s$. The Hagedorn temperature is still approximately maximal in the plateau region. This behavior appears in the ideal gas approximation for sufficiently large dimensionality, provided finite-size effects can be neglected.*

DD directions are noncompact, or we have closed strings). The exponent in (3.11) is $\gamma = -1$ for space-filling open random walks and $\gamma = 0$ for space-filling closed random walks. For open random walks that are well-contained in d_\perp directions we have $\gamma = -1 + d_\perp/2$.

These finite-size effects induce a negative logarithmic correction to the entropy of a highly excited string, which in turn gives it a negative specific heat. Hence, long strings have a tendency to break the equipartition of energy, which would flow into one single long string. This also breaks extensivity. Consider two uncoupled subvolumes of the gas, each with its own single dominating long string. Once brought together there can be only one longest string violating extensivity.

3.2 The full string gas

In normal systems, the thermodynamic or infinite-volume limit is a useful formal tool in the study of the phase structure. In the case of strings, their extended nature puts into question usual assumptions about extensivity of the thermodynamic functions, and the whole issue of the thermodynamic limit must be re-examined by working at finite volume from the outset. However, some heuristic rules of thumb can be envisaged without calculation.

Consider an ensemble of long closed strings with total available energy E . If all this energy flows to a single long string, the random walk acquires size $E^{1/2}$ in string units. The condition

for the walk to be well-contained is thus $E^{1/2} \leq L$. A thermodynamic limit of large L with constant energy density $\rho = E/L^d$ is consistent with this condition only when $1 < \rho \leq L^{2-d}$, which requires $d \leq 2$ (the first inequality follows from the condition of long-string dominance over the massless modes). Hence, we obtain $d = 2$ as the critical (spatial) dimension separating string gases with “normal” thermodynamical behavior from those that have important finite-size effects.

A convenient formalism to discuss the transition from the single long string to a gas of long strings is to obtain the full density of states $\Omega(E)$ from a formal partition function:

$$Z(\beta) = \text{Tr} \exp(-\beta H_{\text{SFT}}) \equiv \int_0^\infty dE \Omega(E) e^{-\beta E} , \quad (3.12)$$

where H_{SFT} denotes the second-quantized Hamiltonian of the full string field theory and the trace is over the physical Hilbert space of the full string theory. To leading order in perturbation theory, H_{SFT} is the direct sum of the free-field Hamiltonians for each particle degree of freedom of the single-string Fock space. The inverse “temperature” β defines a consistent canonical ensemble only for $\beta > \beta_s$. Indeed, above the Hagedorn temperature, single string states corresponding to long random walks cause (3.12) to diverge. Still, if $Z(\beta)$ is defined by analytic continuation in the complex β plane, we can write an integral formula for $\Omega(E)$ as the inverse Laplace transform

$$\Omega(E) = \int_{C_\beta} \frac{d\beta}{2\pi i} e^{\beta E} Z(\beta) , \quad (3.13)$$

where the contour C_β is parallel to the imaginary axis and to the right of all singularities of $Z(\beta)$. The entropy of the string gas is $S(E) = \log \Omega(E)$ and is determined by the singularities of $Z(\beta)$, upon evaluation of the integral (3.13) by contour deformation [16, 7].

Although $Z(\beta)$ can be evaluated explicitly in the one-loop approximation [39], we follow here a more heuristic route. In estimating $Z(\beta)$ near the Hagedorn singularity, we can assume Maxwell–Boltzmann statistics, because the dominating long strings are macroscopic, and thus they behave quasiclassically. We may then write $Z(\beta) = \exp z(\beta)$, where $z(\beta)$ is the single-string partition function. It is related to the single-string density of states by the Laplace transform

$$z(\beta) = \int_0^\infty d\varepsilon \omega(\varepsilon) e^{-\beta \varepsilon} . \quad (3.14)$$

By direct calculation, we find that the behavior of $z(\beta)$ near the Hagedorn singularity $\beta = \beta_s$ is given by

$$z(\beta) \sim f (\beta - \beta_s)^\gamma [\log(\beta - \beta_s)]^\delta , \quad (3.15)$$

where $\delta = 1$ if γ is a non-negative integer and $\delta = 0$ otherwise. We see that the Hagedorn densities (3.11) are associated to critical behavior as a function of the formal canonical temperature $1/\beta$, with a critical exponent given by γ , as in (3.11).

One can evaluate the integral (3.13) in various approximations, depending on the different dynamical regimes of energy and volumes. Whenever the saddle-point approximation is applicable, one finds an equivalence between canonical and microcanonical ensembles, with positive and large specific heat. A necessary condition for this is that $\gamma \leq 1$, ensuring that the canonical internal energy $E(\beta) \sim \partial_\beta z(\beta)$ diverges at the Hagedorn singularity. Looking at the values of γ as a function of the dimensions, we see that stable canonical behavior is to be obtained for closed strings in low-dimensional thermodynamic limits, $d \leq 2$, or open strings with $d_\perp \leq 4$

noncompact DD dimensions, i.e. Dp -branes with $p \geq 5$ and noncompact transverse dimensions. In all these cases, the energy satisfies the usual laws of equipartition in terms of the individual strings.

In the cases that a saddle-point approximation is not available, one can either evaluate the integral exactly in special marginal cases (in particular for $\gamma = 0$), or find a complementary approximation (see [16, 7] for a summary of cases). For example, in certain situations one can perform an expansion in powers of the single-string partition function,

$$Z(\beta) \approx Z(\beta_s) [1 + z(\beta) - z(\beta_s)] + O(|z(\beta) - z(\beta_s)|^2) .$$

In this case, one finds single-string dominance with negative specific heat. The paramount example of this behavior is that of Dp -branes with $p < 5$ in ten non-compact dimensions. Naively, closed strings with $d > 2$ also belong to this category. However we noticed before that the thermodynamic limit of closed strings is sensitive to finite-size effects precisely in this regime of dimensions, so that the large-volume limit must be studied with due attention to these boundary effects. Similarly, open random walks with energy $E > L_{\perp}^2$ are also subject to finite-size effects.

This situation can be illustrated by considering the energy distribution of single long strings in the gas [16, 7]. The number of states with a long string of energy ε , at fixed total energy E , is proportional to

$$D(\varepsilon, E) = \frac{\omega(\varepsilon)\Omega(E - \varepsilon)}{\Omega(E)} . \quad (3.16)$$

In systems where the finite-size effects can be neglected there is a tendency for the energy to be carried dominantly by a single long string, as in figure 8, whereas the energy is uniformly distributed when the long strings are constrained by the available volume, c.f. figure 9.

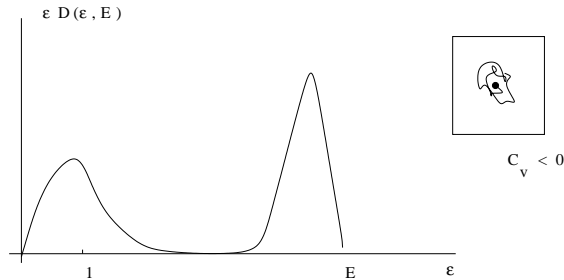

Figure 8: *Single-string energy distribution for a total energy E , in systems where the random walks are well-contained and with large co-dimension. The first peak corresponds to the energy in massless modes. The area below it represents the energy deposited in these modes, of order $\rho_s V$. The second peak corresponds to a single long string that captures $E - \rho_s V$ of the energy. This situation corresponds to an unstable Hagedorn phase, as in figure 7.*

Systems with close-packing of random walks (high energy in a fixed volume) have $\gamma = -1$ for open strings and $\gamma = 0$ for closed strings. In the first case, the saddle point approximation applies and we have a gas of open strings with canonical behavior, positive specific heat and entropy of the form

$$\Omega(E)_{\text{open}} \sim \exp(\beta_s E + C\sqrt{E})$$

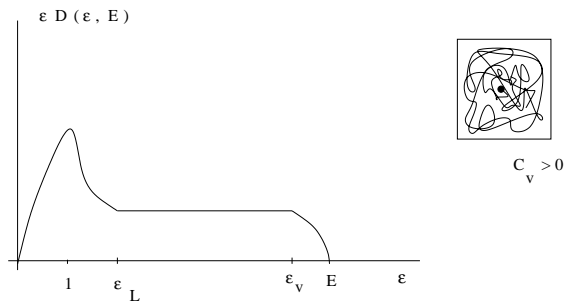

Figure 9: *Single-string energy distribution for systems with a very “dense packing” of random walks in the allowed volume. The initial peak of the massless modes decays to a plateau that starts at $\varepsilon = \varepsilon_L \sim L^2$, the energy of volume-saturating random walks. The plateau continues up to energies $\varepsilon_v \sim E - \rho_s V$. This situation corresponds to a locally stable Hagedorn phase, as in figure 6.*

with some constant C . The case of closed strings is slightly more involved. The leading singularity at very high energy and finite volume $V = L^d$ is always a simple pole of the partition function at the Hagedorn singularity,

$$Z(\beta) = (\beta - \beta_s)^{-1} \cdot Z(\beta)_{\text{regular}} . \quad (3.17)$$

This pole alone produces a multistring density

$$\Omega(E)_{\text{closed}} \sim \exp(\beta_s E + \rho_s V) , \quad (3.18)$$

with $\rho_s = O(1)$ in string units. Hence, the specific heat is still infinite in this approximation. The contribution of the subleading singularities turns the thermodynamics into a weakly limiting behavior with positive specific heat and exponentially suppressed corrections to the linear entropy law. This conclusion can be anticipated by the study of the energy distribution of single long strings. Calculating the distribution function $D(\varepsilon, E)$ from (3.7) and (3.18) one finds $D(\varepsilon, E) \sim 1/\varepsilon$, so that the energy distribution $\varepsilon D(\varepsilon, E)$ is flat for $\varepsilon > L^2$, suggesting equipartition and positive specific heat.

It is interesting to notice that, on volumes of the order of the string scale, the entropy in open strings grows as

$$S(E)_{\text{open}} \sim \beta_s E + C \sqrt{E} ,$$

whereas closed strings are marginally limiting, with

$$S(E)_{\text{closed}} \sim \beta_s E - C' E^{16} e^{-\eta E} ,$$

where C, C' and η are $O(1)$ constants in string units. This means that primordial cosmology scenarios which start with a “small” universe (c.f. [14]), are very sensitive at the possible presence of D-branes in the primordial ingredients, since open strings dominate the density of states in these circumstances [7, 15].

4 The thermal scalar

The critical behavior apparent in equation (3.15) begs for a representation in terms of the dynamics of light modes but, what light modes could possibly have a bearing on this situation, since we are looking at extremely massive string states from the beginning?

An interesting answer can be obtained by a formal detour. We first notice that the random walk in spatial dimensions is the same as the configuration space of a path integral for a relativistic particle in Euclidean space. In this picture, ε is proportional to the length of the walk, and (3.14) is a Schwinger representation of a random world-line of length ε .

Let us consider first the case of a closed random walk and write (3.15) using (3.14) and (3.5),

$$\log Z(\beta) \approx z(\beta) \sim V \int_0^\infty \frac{d\varepsilon}{\varepsilon} \frac{e^{-(\beta-\beta_s)\varepsilon}}{W(\varepsilon)}. \quad (4.19)$$

For the case of a well-contained walk we have

$$W(\varepsilon)^{-1} \sim \varepsilon^{-d/2} \sim \int \frac{d^d k}{(2\pi)^d} e^{-\varepsilon k^2}$$

so that the complete expression (4.19) is just a Schwinger proper-time representation of a one-loop determinant for a scalar field in d dimensions [18],

$$\log Z(\beta) = -\frac{n_{\text{eff}}}{2} \text{Tr} \log \left[-\nabla^2 + m_{\text{eff}}^2(\beta) \right]_{\mathbf{R}^d}, \quad (4.20)$$

where the effective mass $m_{\text{eff}}^2 \sim (\beta - \beta_s)$ is indeed vanishing at the Hagedorn temperature. We have parametrized the normalization of the partition function by the number n_{eff} , an effective number of components of the thermal scalar.

We see that the critical behavior of very long strings can be *formally* parametrized by the dynamics of a light scalar in d Euclidean dimensions. In the ideal-gas approximation considered here, the random walk is identified with the Feynman path of the light scalar particle in Euclidean space.

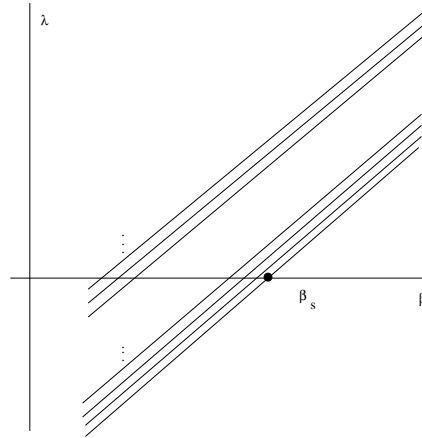

Figure 10: *The eigenvalue spectrum of the operator $-\nabla^2 + m_{\text{eff}}^2(\beta)$ in the vicinity of $\beta \approx \beta_s$. As β decreases, there is a lowest eigenvalue that vanishes at $\beta = \beta_s$. For a finite box of unit size in string units, the eigenvalue spacing is of $O(1)$ and subleading singularities appear below β_s separated by $O(1)$ intervals. For a finite box of size $L \gg \ell_s$, there are associated bands of momentum modes with spacing of order $1/L^2$. In the limit $L \rightarrow \infty$ the bands become quasicontinuous.*

For random walks in finite volume, the spectrum of the operator $-\nabla^2$ is gapped with characteristic scale $1/L^2$, so that the momentum integrals are irrelevant for $\beta - \beta_s \ll 1/L^2$, leading

to a purely logarithmic free energy for β sufficiently close to β_s . In this case the basic canonical singularity for closed strings in finite volume takes the form

$$Z(\beta)_{\text{sing}} \sim \frac{1}{(\beta - \beta_s)^{n_{\text{eff}}/2}}. \quad (4.21)$$

Agreement with (3.17) requires $n_{\text{eff}} = 2$, i.e. the thermal scalar can be considered as a *complex* field. An explicit stringy construction in the next section will confirm this conclusion. The opening of d dimensions in the limit $L \rightarrow \infty$ corresponds to a dense set of poles separated by a distance of $O(1/L^2)$ in β -space, accumulating at $\beta = \beta_s$ and transforming the pole singularity at β_s into a cut of the form (3.15).

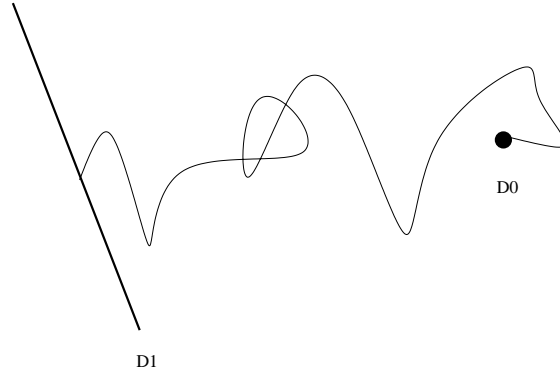

Figure 11: *The random configurations of a long string in space are identified with the random paths of of an Euclidean field χ . Here we show a long open string between D1 and D0 branes or, equivalently, a contribution to the propagator of the thermal scalar.*

The effective thermal scalar description also explains the critical behavior of open strings on D-branes. The geometry of the random walk suggests that the relevant quantity is now the propagator between boundary states:

$$\log Z(\beta)_{pq} \sim \left\langle \text{D}q \left| \frac{1}{-\nabla^2 + m_{\text{eff}}^2(\beta)} \right| \text{D}p \right\rangle, \quad (4.22)$$

where D-brane boundary states project onto the zero-momentum sector in NN directions, and absorb any momentum in the DD directions. Hence, the momenta flowing through the propagator are only those in the DD directions, explaining the factor of $\varepsilon^{-d_{\perp}/2}$ in the number of states' densities.

4.1 Stringy origin of the thermal scalar

The thermal scalar formalism operates in the *spatial* Euclidean space. However, being formally a path-integral representation of a canonical partition function, note that the thermal circle \mathbf{S}_{β}^1 of period β does not feature explicitly in the formalism. In fact, it turns out that the thermal scalar is an effective description in which the thermal circle has been integrated out, and the thermal scalar is one of the light “degrees of freedom” that remains when $\beta \approx \beta_s$. As we shall see now, one can “integrate in” the information regarding \mathbf{S}_{β}^1 , and the result is rather surprising.

To argue this point in the simplest example, consider the one-loop free energy of bosonic open strings. The generalization to superstrings is straightforward and brings no new conceptual issues. At this level we can consider such a free energy as the sum of free energies for each physical particle in the open-string spectrum, so we have an expression of the form

$$\log Z(\beta)_{op} = -\frac{1}{2} \text{Tr}_{op} \log \left[-\partial^2 + M^2 \right]_{X_\beta} \quad (4.23)$$

where the trace sums the spectrum of the operator $-\partial^2 + M^2$, over all the open-string fields. The kinetic operator $-\partial^2$ is defined on the thermal manifold $X_\beta = \mathbf{S}_\beta^1 \times \mathbf{R}^d$ as

$$-\partial^2 = -\partial_\tau^2 - \nabla^2,$$

where τ is a coordinate on \mathbf{S}_β^1 and $-\nabla^2$ is the standard Laplacian on \mathbf{R}^d . Passing to a Schwinger proper-time representation and isolating the discrete eigenvalues of $-\partial_\tau^2 = 4\pi^2 n^2/\beta^2$, we get contributions of the form

$$\log Z(\beta)_{op} = \frac{1}{2} \int_0^\infty \frac{dt}{t} \left[\dots \sum_n e^{-2\pi t(4\pi^2 n^2/\beta^2 + \dots)} \right]. \quad (4.24)$$

In this formula and the rest of the section, we pay no attention to the ultraviolet divergences at small Schwinger parameter, since the β -dependent part of the partition function is finite. To this end, we adopt the prescription of subtracting the contribution of the vacuum energy from $\log Z(\beta)$.

In a world-sheet path-integral picture, we have a one-loop vacuum diagram of open strings, the annulus with modular parameter t . The momentum modes in the thermal circle can be transformed into winding modes of the string world-sheet around the thermal circle by Poisson resummation in the index n , resulting in terms of the form

$$\frac{1}{\sqrt{t}} \sum_\ell e^{-\beta^2 \ell^2 / 8\pi t}. \quad (4.25)$$

We can see that ℓ is a winding number by constructing the embeddings of the annulus that wrap ℓ times on the thermal circle, $\tau = \ell\beta\sigma_2/t$, with action

$$S_\ell = \frac{1}{4\pi} \int_0^\pi d\sigma_1 \int_0^{2\pi t} d\sigma_2 \left(\frac{\partial\tau}{\partial\sigma_2} \right)^2 = \frac{\beta^2 \ell^2}{8\pi t},$$

so that we recover (4.25) as a semiclassical sum $\sum_\ell \exp(-S_\ell)$. A further change of variables $s = 1/t$, represents the modular transformation to the closed-string channel, in which we see a tree-level cylinder diagram of closed strings with modular parameter s . The closed strings carry now winding modes around the thermal circle. Detailed inspection of these manipulations in the complete expression above shows that all powers of s can be exponentiated in the proper time integral so that one finds [21]

$$\log Z(\beta)_{op} \sim \int_0^\infty ds \text{Tr}_{cl} \sum_\ell \exp \left[-\frac{\pi}{2} s \left(-\nabla^2 + M_\ell^2(\beta) \right) \right], \quad (4.26)$$

which has the form of a proper-time representation of a propagator, just like (4.22). The trace Tr_{cl} runs now over the whole tower of closed-string states. The crucial point is the emergence of effective mass terms proportional to β^2 , i.e. we have

$$M_\ell^2 = \frac{\beta^2 \ell^2}{4\pi^2} + \dots,$$

which can be interpreted as winding modes of closed strings on \mathbf{S}_β^1 . The lightest of these winding modes, corresponding to $\ell = \pm 1$, can be assembled into a complex scalar field χ . Now, since the thermal circle breaks supersymmetry, the spectrum of the operator M_ℓ^2 in these winding sectors is not guaranteed to be positive definite, but has actually a negative lowest eigenvalue $-|M_0|^2$. Defining $\beta_s = 2\pi|M_0|$ we have an effective mass

$$m_{\text{eff}}^2(\beta) = \frac{\beta^2 - \beta_s^2}{4\pi^2},$$

as required for the thermal scalar. Hence, we see that the stringy origin of the thermal scalar is in the thermal winding modes of the closed-string sector. The critical behavior arises because this thermal scalar becomes massless at $\beta = \beta_s$.

4.2 Is the thermal scalar “physical”?

The parametrization of long-string critical behavior in terms of an effective thermal scalar poses the question of the physical interpretation of these degrees of freedom. In the path-integral picture they arise naturally as closed-string winding modes around the thermal circle. However, the Hamiltonian interpretation of these modes is not immediate, and therefore its physical status remains somewhat unclear.

In open-string sectors modular covariance (open-closed string duality) provides an answer to the previous question. The closed-string winding modes in the closed-string channel are dual under Poisson resummation of the ordinary momentum modes of open strings in the crossed channel. Hence, the physical Hamiltonian only has open-string modes and no states of the field χ are visible among the physical open-string spectrum.

On the other hand, the answer is less obvious in the closed-string sector. The one-loop diagram of closed strings has two independent winding modes, one for each of the cycles of the worldsheet torus. One set of winding modes can be interpreted as a Poisson dual of standard momentum modes on \mathbf{S}_β^1 . However, another set of winding modes remains and we still need to find a Hamiltonian interpretation for those. In such a Hamiltonian interpretation, they would appear as “timelike” winding modes, a rather mysterious notion.

The resolution of this paradox is again related to modular invariance. Following the “empirical” reasoning of the previous section, we start from the physical Hamiltonian picture, i.e. we consider the thermal free energy in the ideal gas approximation as given by the sum of free energies for all field degrees of freedom in the spectrum:

$$\log Z(\beta) = \log \text{Tr}_{\text{SFT}} e^{-\beta H_{\text{SFT}}} = - \sum_f \text{Tr}_{(f)} \log \left(1 - e^{-\beta \omega_f} \right), \quad (4.27)$$

where $\text{Tr}_{(f)}$ runs over the momentum and spin degrees of freedom of each field in the string spectrum. Standard manipulations yield an expression in terms of determinants on the Euclidean manifold $X_\beta = \mathbf{S}_\beta^1 \times \mathbf{R}^d$,

$$\log Z(\beta) = -\frac{1}{2} \sum_f \text{Tr} \log \left[-\partial^2 + M_f^2 \right]_{X_\beta}, \quad (4.28)$$

where now the trace runs over the spectrum of the kinetic operator on the Euclidean manifold X_β . In a Schwinger representation,

$$\log Z(\beta) = \frac{1}{2} \int_0^\infty \frac{d\tau_2}{\tau_2} \sum_f \text{Tr} \exp \left[-\frac{\pi}{2} \tau_2 (-\partial^2 + M_f^2)_{X_\beta} \right]. \quad (4.29)$$

Now we notice that $\frac{1}{2}(-\partial^2 + M^2) = L_0 + \bar{L}_0$, with L_0 the chiral world-sheet Hamiltonian of the string theory. Introducing a level-matching constraint

$$\delta_{(L_0, \bar{L}_0)} = \int_{-1/2}^{1/2} d\tau_1 e^{2\pi i \tau_1 (L_0 - \bar{L}_0)},$$

we can write a formal expression

$$\log Z(\beta) = \frac{1}{2} \int_S \frac{d^2 \tau}{\tau_2^2} \tau_2 \text{Tr}_{\text{CFT}} q^{L_0} \bar{q}^{\bar{L}_0}, \quad (4.30)$$

where $q = e^{2\pi i \tau}$, with $\tau = \tau_1 + i\tau_2$. Equation (4.30) resembles the string world-sheet partition function, except for the fact that the integration domain $S : \tau > 0, -\frac{1}{2} < \tau_1 < \frac{1}{2}$ does not coincide with the fundamental domain of the modular group $F : |\tau| > 1, -\frac{1}{2} < \tau_1 < \frac{1}{2}$. In addition, the trace only includes *physical* modes on \mathbf{R}^d that were already traced over in the statistical sums (4.28) and (4.29), i.e., there are momentum modes on \mathbf{S}_β^1 , but no winding modes. In particular, this implies that the integrand cannot be modular invariant.

It turns out that these two facts essentially cancel one another. One can trade the summation over thermal winding modes by an extension of the integration region from the fundamental domain F to the strip S (c.f. [36]). The basic identity is

$$\sum_{(\ell, \ell') \neq (0, 0)} \int_F \frac{d^2 \tau}{\tau_2^2} f(\tau, \bar{\tau}) e^{-\frac{\beta}{4\pi\tau_2} |\ell' + \tau\ell|^2} = \sum_{\ell \neq 0} \int_S \frac{d^2 \tau_2}{\tau_2^2} f(\tau, \bar{\tau}) e^{-\frac{\beta}{4\pi\tau_2} \ell^2}, \quad (4.31)$$

where $f(\tau, \bar{\tau})$ is modular invariant. The restriction in the winding sums in (4.31) ensures that the vacuum energy, or $\beta \rightarrow \infty$ limit, is subtracted, a necessary condition for the theorem to hold. Equivalently, we can use the normal-ordered H_{SFT} in (4.27), although in the case of superstrings this term vanishes from the outset. Thus, modular invariant expressions always have two sets of thermal winding modes, but ‘‘Hamiltonian’’ representations automatically unwrap one of these sets. The remaining one can be dualized into standard momentum modes on \mathbf{S}_β^1 , as in the previous subsection.

There are some subtleties that we have chosen to hide. For example, the identity (4.31) must be used for $\beta > \beta_s$, due to convergence problems that can affect the analytic structure of $\log Z(\beta)$ [40].

The conclusion is that the thermal scalar does not have a strict physical interpretation in terms of the particle degrees of freedom of the original thermal gas. Rather, it is a formal device which reconciles the subtleties of stringy modular invariance with the rules of effective field theory.

5 Tachyon dynamics and the Hagedorn transition

We have seen that the canonical formalism just below the Hagedorn temperature, $0 < \beta - \beta_s \ll 1$, involves an effective light field whose quanta are topological winding modes that lack a direct Hamiltonian interpretation. We can write an effective action for *static* and *spatial-dependent* configurations, in the spirit of Landau’s mean-field formalism,

$$S[\chi]_{\text{eff}} = \frac{\beta}{2g_s^2} \int_{\mathbf{R}^d} (|\nabla\chi|^2 + V_{\text{eff}}(\chi^*\chi) + \dots), \quad (5.32)$$

where

$$V_{\text{eff}}(\chi^* \chi) = \frac{\beta^2 - \beta_s^2}{4\pi^2} |\chi|^2 + \text{interactions} \quad (5.33)$$

and the dots stand for contributions of other light degrees of freedom, such as the ordinary massless modes of the string spectrum. A potential has been included to account for interaction corrections. Since the critical behavior is characterized by χ becoming massless at $\beta = \beta_s$, the “post-Hagedorn” regime is formally described by a tachyonic χ field. In this case, it is natural to associate the dynamics of “tachyon condensation” with a phase transition at the Hagedorn temperature. This “dynamics” remains somewhat formal, since the interpretation of the effective action (5.32) as a thermal effective potential is only valid for static configurations. Therefore, the “rolling down” along the tachyonic potential is not to be seen as a process in real time. Rather, we just compare the free energies of static configurations with different values of $|\chi|^2$, averaged over \mathbf{R}^d . These static backgrounds, being off-shell, can be seen as building a renormalization-group flow on the string world-sheet.

It turns out that the picture of a “tachyon roll” down an unstable potential is separated from the perturbative phase $\langle |\chi|^2 \rangle = 0$ by a first-order phase transition. The authors of [23] noticed that the interaction of certain gravitational moduli with the thermal scalar induce an unstable quartic term in the effective potential. The full low-energy effective action on \mathbf{R}^d includes the ten-dimensional dilaton and graviton fields coming from the dimensional reduction on \mathbf{S}^1

$$S_{\text{eff}} \sim \frac{\beta}{g_s^2} \int_{\mathbf{R}^d} e^{-2\phi} \sqrt{|g|} \left[-R - 4(\partial\phi)^2 + |\partial\chi|^2 + \frac{\beta^2 g_{\tau\tau} - \beta_s^2}{4\pi^2} |\chi|^2 + \dots \right] \quad (5.34)$$

where the term $g_{\tau\tau}\beta^2$ represents the effect of fluctuations in the proper length of the thermal circle (see figure 12). Since this is interpreted as a local inverse temperature, (5.34) incorporates the effect of local temperature fluctuations in the mean-field approximation.

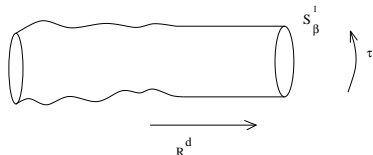

Figure 12: The substitution $\beta^2 \rightarrow \beta^2 g_{\tau\tau}$ has the effect of including local temperature fluctuations on X_β .

Writing $g_{\tau\tau} = 1 + \sigma$ and expanding the σ dependence in a weak-field approximation, we have a tree-level coupling of the form $\sigma \chi^* \chi$ which is not suppressed by derivatives or by powers of $\beta - \beta_s$. This coupling is real, so that integrating out the σ field at tree level gives a negative-definite quartic coupling for χ of the form

$$V_{\text{eff}} \sim -\frac{\beta}{2g_s^2} \left\langle \chi^* \chi \left| \frac{1}{-\nabla^2} \right| \chi^* \chi \right\rangle. \quad (5.35)$$

This term is non-local because the field σ is massless. It is infrared divergent when evaluated on constant χ configurations. However, a finite-volume regularization with a gap in the spectrum of ∇^2 renders it well-defined. The resulting picture is represented in figure 13. The effective potential describes a first-order phase transition occurring slightly below the Hagedorn temperature, when the thermal scalar perturbative vacuum $\langle |\chi|^2 \rangle = 0$ is still locally stable.

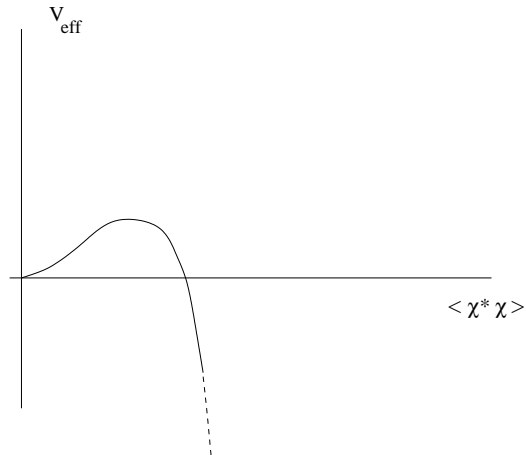

Figure 13: *The qualitative form of the thermal scalar potential for $\beta > \beta_s$.*

5.1 AdS regularization and Euclidean black holes

The Atick–Witten transition proceeds by nucleation of a domain with $\langle |\chi|^2 \rangle \neq 0$, followed by a “roll” down the effective potential, a classical process that could perhaps be described in terms of world-sheet renormalization-group flows, in analogy with similar processes in the decay of D-branes [38] and tachyonic orbifold singularities [32].

The particular endpoint of the condensation process depends on the mechanism of stabilization of the potential (5.35). This should be related to the details of the finite-volume regularization, but we can expect in any case that the means to resolve this problem remains beyond the weak-field methods that lead to (5.35). The related question of what physical interpretation should we assign to the thermal scalar condensate $\langle |\chi|^2 \rangle$ becomes especially acute in view of the considerations of the previous subsection on the “formal” nature of the thermal winding modes.

In order to answer these questions, even at the heuristic level, we must go back to the physical picture of section 1. The main lessons of the microcanonical approach are the following:

(i) The naive infinite volume thermodynamical limit is inconsistent with the instabilities of gravity. Even the mild finite-size effects of free long strings are important given the marginal instability of the Hagedorn regime. This means that the mean-field approximation based on the thermal scalar effective action on $X_\beta = \mathbf{S}_\beta^1 \times \mathbf{R}^d$ must be supplemented with an appropriate infrared cutoff.

(ii) Using AdS spaces as an infrared regulator, we have non-perturbative physical intuition in terms of the thermodynamics of the dual CFT, specified at short distances by a gauge field theory. The Hagedorn gas of long strings becomes a metastable superheated state.

(iii) The microcanonical picture of the first-order phase transition in AdS-regularized spaces involves black hole nucleation, with latent heat of order $1/g_s^2$ (c.f. figure 4).

Let us consider then the AdS regularization of a ten-dimensional string gas in the standard $\text{AdS}_5 \times \mathbf{S}^5$ background of type IIB string theory. The metric takes the form

$$ds^2 = - \left(1 + \frac{r^2}{R^2} \right) dt^2 + \left(1 + \frac{r^2}{R^2} \right)^{-1} dr^2 + r^2 d\Omega_3^2 + R^2 d\Omega_5^2, \quad (5.36)$$

with $R^4 = g_s N$ in string units and N the quantum of RR flux on \mathbf{S}^5 . At a non-perturbative

level, this system is defined by the quantum mechanics of $SU(N)$ super Yang–Mills theory on a three-sphere of radius R and with Yang–Mills coupling $g^2 = g_s$. For $g_s N \gg 1$, the metric is approximately flat on scales small compared to the radius of curvature R . A thermal ensemble defined with respect to the time variable in (5.36) has local temperature

$$T(r) = \frac{T(0)}{\sqrt{1 + r^2/R^2}}.$$

Hence, on scales $\ell_s \ll r \ll R$ we have a macroscopic quasi-flat region with gas at temperature $T \approx T(0)$. The gravitational redshift freezes the temperature on scales larger than the radius of curvature, and we see that AdS works like a finite box of size R as far as thermodynamics is concerned. The Euclidean manifold describing this ensemble is X_β , obtained from (5.36) by the standard Wick rotation $t \rightarrow i\tau$, followed by the periodic identification $\tau \equiv \tau + \beta$, with $\beta = 1/T(0)$. This manifold looks locally like $\mathbf{S}_\beta^1 \times \mathbf{R}^9$ on scales $r \ll R$. In particular, if $\beta \approx \beta_s$, we have a regularized version of the standard thermal manifold with light thermal winding modes localized on the region $r < R$ (thermal winding modes supported at $r \gg R$ have mass proportional to $\beta(r) = \beta\sqrt{1 + r^2/R^2} \gg \beta_s$).

The reasoning of ref. [23] can be applied to type IIB strings on X_β and one expects a first-order phase transition towards a background with non-vanishing values of the thermal scalar $\langle |\chi|^2 \rangle \neq 0$. Now, in order to understand the geometrical interpretation of this condensation process, we can simply look at the endpoint of the decay in the dual CFT. This should be the thermal equilibrium state at the corresponding temperature. Since we have $T \sim T_s \gg 1/R$ in the decay of the superheated ‘‘Hagedorn’’ states, the endpoint is the plasma phase of the CFT with entropy of $O(N^2) = O(g_s^{-2})$. In the gravity description, this is the large AdS black hole at temperature $T \gg 1/R$ [47].

The Euclidean manifold corresponding to this endpoint of the decay is the Euclidean section of the AdS black hole with metric

$$ds^2 = \left(1 + \frac{r^2}{R^2} - \frac{M}{Cr^2}\right) d\tau^2 + \left(1 + \frac{r^2}{R^2} - \frac{M}{Cr^2}\right)^{-1} dr^2 + r^2 d\Omega_3^2 + R^2 d\Omega_5^2, \quad (5.37)$$

where $C = 3\text{Vol}(\mathbf{S}^3)/16\pi G_N$ and M is the mass

$$M = C \left(\frac{r_+^4}{R^2} + r_+^2 \right).$$

The horizon radius r_+ is that of the larger of the solutions of the following equation

$$\beta = \frac{2\pi R^2 r_+}{2r_+^2 + R^2},$$

the smaller solution r_- corresponds to a smaller black hole with negative specific heat. In the regime of interest for us, $\beta \ll R$, we have $r_+ \approx \pi R^2/\beta$.

The manifold X_{bh} has topology $\mathbf{R}^2 \times \mathbf{S}^3 \times \mathbf{S}^5$, which can be interpreted as a ‘‘capping’’ of X_β that removes the flat cylinder region $r \ll R$. This capping can be seen as a progressive effect if we consider manifolds $X(r_c)$ that interpolate between X_β and X_{bh} . One such set of manifolds is given by the Euclidean rotations of off-shell black holes, each of which has a metric of the form (5.37), but with a horizon parameter r_c unrelated to the Euclidean time period β . In this case,

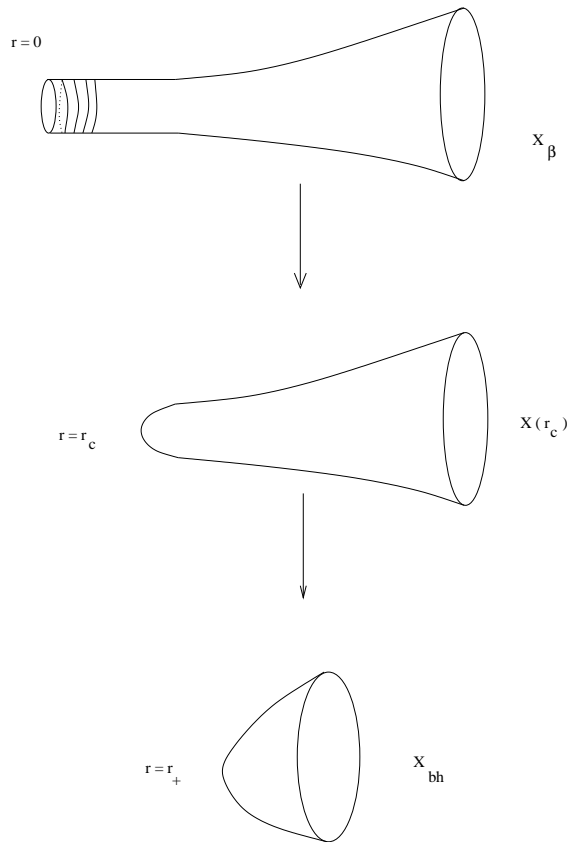

Figure 14: A cartoon of the flow between the original thermal AdS space, with condensing winding modes in the cylinder region $r \ll R$, and the final Euclidean AdS black hole, which does not support winding modes. A set of interpolating metrics can be interpreted physically as off-shell black holes (c.f. [47, 31]).

there is a conical singularity at $r = r_c$ that should be smoothed out by α' corrections in the string theory. The geometrical picture (figure 14) is very similar to that of non-supersymmetric orbifold decay [32, 37].

The Euclidean action of these off-shell black holes reads

$$I(r_c) = \beta M(r_c) - S(r_c) = C \left[\frac{\beta r_c^4}{R^2} + \beta r_c^2 - \frac{4r_c^3}{3} \right] \quad (5.38)$$

and is depicted in figure 15. Its shape is very similar to that of the thermal scalar potential depicted in figure 13. In fact, we propose that the description in terms of the thermal scalar condensate matches, in the sense of a string/black-hole correspondence principle, the flow of capped manifolds $X(r_c)$ with the value of the condensate $\langle |\chi|^2 \rangle$ roughly identified with the extension of the capping, r_c . According to this hypothesis, the function (5.38) would be roughly related to V_{eff} of Eq. (5.35) by

$$I(r_c) \sim \beta R^9 V_{\text{eff}} .$$

This also suggests that the first-order transition of ref. [23] is related to the semiclassical black hole nucleation process studied in [24].

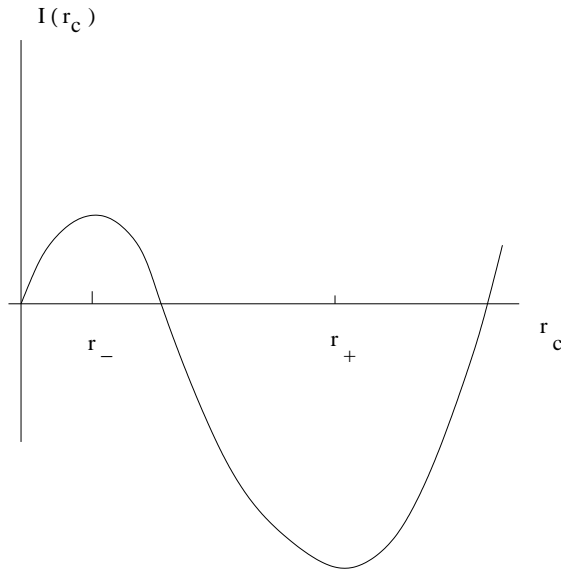

Figure 15: *The Euclidean action of off-shell black holes with varying mass and fixed AdS temperature.*

One consequence of this line of argument is that, upon removing the infrared regulator in the original X_β manifold, i.e. by sending $R \rightarrow \infty$ at fixed β and fixed ℓ_s , the stable endpoint manifold X_{bh} recedes to $r_+ \rightarrow \infty$ and becomes locally flat. Hence, in some sense the endpoint of the Hagedorn decay of a hot ten-dimensional space is a Euclidean, supersymmetric \mathbf{R}^{10} background (c.f. [47]).

Finally, it was proposed [47, 31] that the excluded volume in the quasi-flat region, $\text{Vol}_{\text{eff}} \sim R^9 - r_c^9$ can be used as a measure of the number of the depleted degrees of freedom, providing a concept of “local central charge” that characterizes the irreversibility of the renormalization-group flow, analogous to similar concepts in the theory of boundary flows [19].

6 Topology change and winding modes

We have argued that the χ condensate is not to be interpreted in terms of “particles” in the vacuum, but rather as an order parameter for a topology-change process, in which part of the spacetime is removed by a “bubble of nothing” similar to that described in [30] (see figure 16). This relation between tachyon condensation and dynamics of topology change has appeared in other, more controlled contexts, such as the physics of D-brane annihilation (figure 17) [20]. The common phenomenon is that a topologically-supported string becomes tachyonic. Up to identifications, the string is embedded in the target space manifold as an interval, i.e. locally a copy of \mathbf{R} . The condensation can be envisaged as a process by which the string “fattens up” into a cylinder by the transition

$$\mathbf{R} \rightarrow \mathbf{S}^{d-1} \times \mathbf{R}, \quad (6.39)$$

in such a way that the interior of \mathbf{S}^{d-1} becomes an empty hole in spacetime. Hence, we have a wormhole that grows and “eats up” the original manifold until infrared effects stabilize it (such

as negative curvature of AdS in our case). Locally in Euclidean spacetime, the flop has the form

$$\mathbf{R}^d \times \mathbf{S}^1 \longrightarrow \mathbf{S}^{d-1} \times \mathbf{R}^2. \quad (6.40)$$

In this topological jump, a non-contractible \mathbf{S}^1 that supported the tachyonic winding modes becomes contractible, so that the winding modes can be unwrapped in the new geometry. This is entirely similar to the behavior of open strings in the reconnection process of D-brane annihilation, including the “fattening” process in (6.39) (c.f. figures 16 and 17).

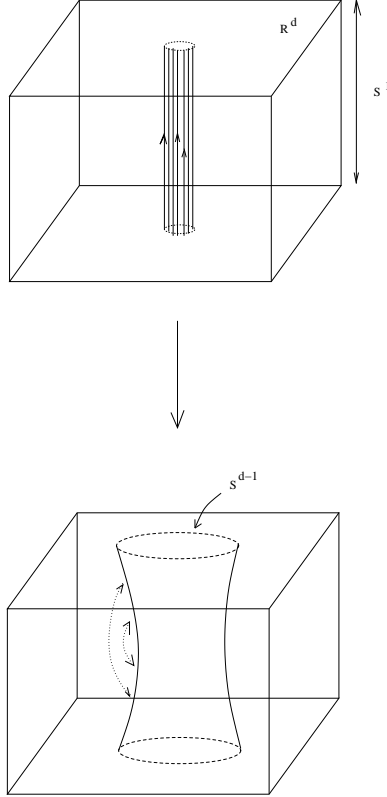

Figure 16: *The bottom picture is a local rendering of the basic flop responsible for the Hagedorn transition: $\mathbf{R}^d \times \mathbf{S}^1 \longrightarrow \mathbf{S}^{d-1} \times \mathbf{R}^2$, that represents the condensation of many thermal winding strings (top picture). Notice that the “inside” of \mathbf{S}^{d-1} is hollow. In these drawings, opposite points in the top and bottom planes are identified, together with points reflected about the plane of symmetry of the throat with \mathbf{S}^{d-1} sections.*

6.1 A toy model on supersymmetric cycles

Our geometrical interpretation of the Hagedorn transition is mostly based on physical considerations in the light of the AdS/CFT correspondence. It would be interesting to obtain a more explicit derivation of the equivalence between thermal winding condensation and the topological jump (6.40). In this respect, the maximal violation of supersymmetry by the high temperatures is of no particular help (see, however [33]). In addition, the winding modes are massless at $\beta = \beta_s \sim \ell_s$, far from the boundaries of the moduli space of \mathbf{S}^1 compactifications.

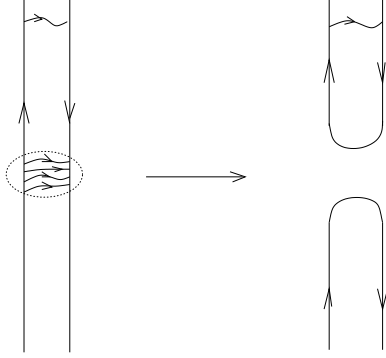

Figure 17: In D -brane annihilation, the condensation of tachyonic strings stretching between the brane and the antibrane can be depicted semiclassically as the reconnection of both Dp -branes. The reconnection generates a throat that is unstable to growth; this throat is nothing but the original stretched string in the “BIon” picture of ref. [20], in which the string is locally homeomorphic to $\mathbf{R} \times \mathbf{S}^{p-1}$.

This means that T-duality on the thermal circle \mathbf{S}^1_β (c.f. [35]) is of limited use in elucidating the dynamics involved, since this dynamics occurs close to the self-dual point. A related system in which these difficulties can be partially tamed is defined by a variation of the previous AdS/CFT background [22, 41, 42] (see also [43]).

Consider the type IIB D3-brane background, with the AdS factor in Poincaré coordinates and large $r \rightarrow \infty$ asymptotics

$$ds^2 \longrightarrow \frac{r^2}{R^2} (d\tau^2 + dx^2 + d\vec{y}^2) + \frac{R^2}{r^2} dr^2 + R^2 d\Omega_5^2, \quad (6.41)$$

where τ is compactified with length β , with supersymmetry-breaking spin structure, whereas x is compactified with length L , with supersymmetry-preserving spin structure. The coordinates \vec{y} span non-compact \mathbf{R}^2 . The dominant background with these boundary conditions is the black D3-brane in the near-horizon limit, which differs from (6.41) by the substitutions

$$d\tau^2 \longrightarrow h(r) d\tau^2, \quad dr^2 \longrightarrow dr^2/h(r),$$

with $h(r) = 1 - (r_0/r)^4$ and $r_0 = \pi R^2/\beta$. This background has topology $\mathbf{R}^2 \times \mathbf{R}^2 \times \mathbf{S}^1 \times \mathbf{S}^5$, the radial coordinate is restricted to $r \geq r_0$, and it supports winding modes on the circle parametrized by x . In the limit $\beta \rightarrow \infty$, or $r_0 \rightarrow 0$, the winding modes on circles at small r become massless, and we may ask the question of the what effective dynamics resolves this singularity.

In this case, the dynamics of light winding modes at $r \rightarrow 0$ can be transformed into a more intuitive large-volume effect by standard T-duality on the circles at fixed r . Hence, at $r \approx r_s = R/L$ the metric is matched to the T-dual

$$ds_{\text{smearred}}^2 = \frac{r^2}{R^2} (h(r) d\tau^2 + d\vec{y}^2) + \frac{R^2}{r^2} \left(\frac{dr^2}{h(r)} + d\tilde{x}^2 \right) + R^2 d\Omega_5^2. \quad (6.42)$$

Now \tilde{x} is identified with period $2\pi/L$ and the proper size of the \mathbf{S}^1 fibers grows as $r \rightarrow 0$. The T-duality transformation allows us to use the supergravity of standard momentum modes in

the T-dual background (6.42) to elucidate the dynamics of light winding modes in the original metric. This T-dual metric is exactly the near-horizon limit of the so-called “smeared” D2-brane solution. This is the metric generated by a D2-brane, averaged over the \tilde{x} coordinate. We can also consider the localized D2-brane solution, with the same asymptotic conditions, which breaks translational invariance in the \tilde{x} direction and has topology $\mathbf{R}^2 \times \mathbf{R}^2 \times \mathbf{S}^6$. Explicit inspection shows that the Euclidean action of the localized solution dominates at sufficiently small r_0 , leading to a first-order phase transition, since both backgrounds are locally stable at the transition point (they both have positive specific heat with respect to the temperature $1/\beta$).

Thus, we have a transition on Gregory–Laflamme type [46], between locally stable backgrounds, with a basic topological jump given by the flop

$$\mathbf{S}^1 \times \mathbf{S}^5 \longrightarrow \mathbf{S}^6 .$$

We see that the non-contractible cycle supporting the original winding modes again disappears and is replaced by a contractible geometry, along the lines of our general scenario in the last section. We can think of the transition as the result of winding-mode condensation, because the breaking of translational invariance in \tilde{x} is equivalent to the condensation of momentum modes in the background (6.42), which are exactly the winding modes of the original vanishing cycle.

The interpretation of these geometrical transitions in the dual gauge theory is interesting. They are large- N phase transitions that characterize the effect of a finite-size toroidal compactification in the thermodynamics of the gauge theory. At weak coupling, this is just the change in the scaling of the entropy from $S \sim T^3$ to $S \sim T^2$ as the temperature drops below the threshold $T_L \sim 1/L$ (see figure 18).

7 Conclusion

We have discussed some, but by no means all, systems, which have a Hagedorn ridge. What was common to all the systems discussed was that for them the ridge is just a transient one passes as one increases their energy. We have described various components which each play in their turn a role in defining the thermodynamical properties of strings. In particular a variety of black holes and black strings turn out to best represent the degrees of freedom at very high energy.

We have discussed both broad and detailed features of the Hagedorn ridge. Ian’s work and many following ones imagine that spacetime melts away as one reaches the end point of the ridge. The separation into perturbative world-sheet physics (i.e. a string picture) and target space (i.e. a geometry in which the strings propagate) becomes questionable. While these are perhaps yet to be uncovered phases of gravity, their properties, as consistent world-sheet theories possessing a total vanishing Virasoro central charge, are yet to be elaborated on.

In this essay we brought up a milder form of the disappearance as well as topological transmutation of chunks of spacetime but not all of it. The nucleation of black holes has become important at the edge of the Hagedorn ridge. Portions of space-time have been expelled as these black holes stabilize, they cause a topology change and in some cases even lead all the way to flat ten dimensional supersymmetric space-time. There may yet be vistas to be discovered and bumps to be negotiated as one traverses the ridge. We miss Ian’s guidance for these future ventures.

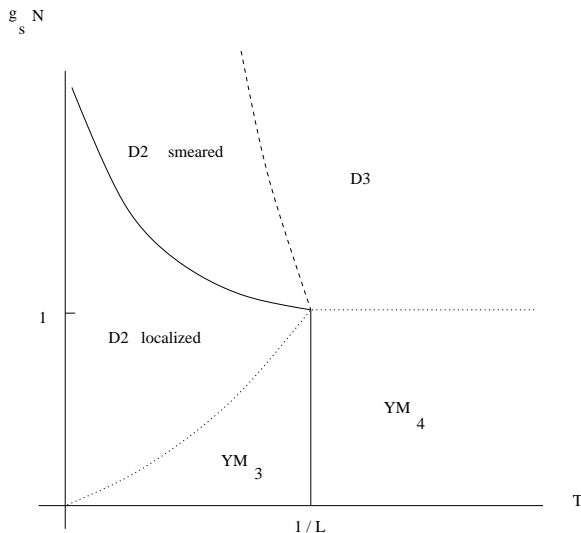

Figure 18: Phase diagram of the D3-brane theory as a function of the 't Hooft coupling $g_s N$ and the temperature, with a compactified direction of length L (c.f. [22]). At weak coupling $g_s N < 1$ we have the Yang–Mills gas descriptions in four or three dimensions, with the standard threshold for finite size effects at $LT \sim 1$. At strong coupling, $g_s N > 1$ we have the AdS dual description given by the black D3-brane metric at high temperatures. At lower temperatures we have a smooth transition to the smeared black D2-brane metric and then a topological transition to the localized black D2-brane metric. The dotted lines denote correspondence lines between perturbative Yang–Mills descriptions and supergravity descriptions, whereas full lines denote thresholds for finite-size effects on the thermodynamic functions. The localization transition is of first order in the supergravity approximation. The thermodynamic functions calculated in the classical gravity approximation do not change across the T-duality transition (dashed line). The supergravity backgrounds to the left of the T-duality transition are dominated by modes that are interpreted as light winding modes from the point of view of the original D3-brane metric. More general phase diagrams, including effects of large- N nonlinearities appear in [48].

Acknowledgments

We would like to thank Steve Abel, Ofer Aharony, Shmuel Elitzur and Miguel A. Vázquez-Mozo for many discussions and/or collaborations on the subject of this essay. The work of J.L.F.B. was partially supported by MCyT and FEDER under grant BFM2002-03881 and the European RTN network HPRN-CT-2002-00325. The work of E.R. is supported in part by the Miller Foundation, the BSF-American Israeli Bi-National Science Foundation, The Israel Science Foundation-Centers of Excellence Program, The German-Israel Bi-National Science Foundation and the European RTN network HPRN-CT-2000-00122.

References

- [1] R. Hagedorn, *Suppl. Nuovo Cimento* **3**, 147 (1965).
- [2] I.I. Kogan, *JETP Lett.* **45**, 709 (1987); B. Sathiapalan, *Phys. Rev. D* **35**, 3277 (1987).
- [3] N. Cabibbo and G. Parisi, *Phys. Lett. B* **59**, 67 (1975).
- [4] C. Thorn, *Phys. Lett. B* **99**, 458 (1981).
- [5] S. Fubini and G. Veneziano, *Nuovo Cimento A* **64**, 1640 (1969); K. Huang and S. Weinberg, *Phys. Rev. Lett.* **25**, 895 (1970); S. Frautschi, *Phys. Rev. D* **3**, 2821 (1971); R.D. Carlitz, *Phys. Rev. D* **5**, 3231 (1972); E. Alvarez, *Phys. Rev. D* **31**, 418 (1985); *Nucl. Phys. B* **269**, 596 (1986); M. Bowick and L.C.R. Wijewardhana, *Phys. Rev. Lett.* **54**, 2485 (1985); B. Sundborg, *Nucl. Phys. B* **254**, 883 (1985); S.N. Tye, *Phys. Lett. B* **158**, 388 (1985); E. Alvarez and M.A.R. Osorio, *Phys. Rev. D* **36**, 1175 (1987); P. Salomonson and B. Skagerstam, *Nucl. Phys. B* **268**, 349 (1986); *Physica A* **158**, 499 (1989); D. Mitchell and N. Turok, *Phys. Rev. Lett.* **58**, 1577 (1987); *Nucl. Phys. B* **294**, 1138 (1987); I. Antoniadis, J. Ellis and D.V. Nanopoulos, *Phys. Lett. B* **199**, 402 (1987); M. Axenides, S.D. Ellis and C. Kounnas, *Phys. Rev. D* **37**, 2964 (1988); M. Mc Guigan, *Phys. Rev. D* **38**, 552 (1988); A.A. Abrikosov Jr. and Ya. I. Kogan *Int. J. Mod. Phys. A* **6**, 1501 (1991) (submitted 1989), *Sov. Phys. JETP* **69**, 235 (1989); M.J. Bowick and S.B. Giddings, *Nucl. Phys. B* **325**, 631 (1989); S.B. Giddings, *Phys. Lett. B* **226**, 55 (1989); F. Englert and J. Orloff, *Nucl. Phys. B* **334**, 472 (1990); S.A. Abel, *Nucl. Phys. B* **372**, 189 (1992); J.L.F. Barbón and M.A. Vázquez-Mozo, *Nucl. Phys. B* **497**, 236 (1997) [hep-th/9701142]; M. Laucelli Meana, M.A.R. Osorio and J. Puente Penalba, *Phys. Lett. B* **400**, 275 (1997) [hep-th/9701122]; *Phys. Lett. B* **408**, 183 (1997) [hep-th/9705185]; S.S. Gubser, S. Gukov, I.R. Klebanov, M. Rangamani and E. Witten, *J. Math. Phys.* **42**, 2749 (2001) [hep-th/0009140]; J.L.F. Barbón and E. Rabinovici, *JHEP* **06**, 029 (2001) [hep-th/0104169]; K. R. Dienes and M. Lennek, *Thermal duality confronts entropy: a new approach to string thermodynamics?* hep-th/0312173; M.A. Cobas, M.A.R. Osorio and M. Suarez, *Thermodynamic nonextensivity in a closed string gas*, hep-th/0406043.
- [6] G. 't Hooft, *Nucl. Phys. B* **256**, 727 (1985); T. Banks, *A critique of pure string theory: Heterodox opinions of diverse dimensions*, hep-th/0306074.
- [7] S.A. Abel, J.L.F. Barbón, I.I. Kogan and E. Rabinovici, *JHEP* **04**, 015 (1999) [hep-th/9902058].
- [8] S.A. Abel, J.L.F. Barbón, I.I. Kogan and E. Rabinovici, *Some thermodynamical aspects of string theory*, hep-th/9911004.
- [9] G. 't Hooft, *Dimensional Reduction In Quantum Gravity*," gr-qc/9310026; J. Bekenstein, *Phys. Rev. D* **49**, 1912 (1994) [gr-qc/9307035]; L. Susskind, *J. Math. Phys.* **36**, 6377 (1995) [hep-th/9409089].
- [10] O. Aharony, M. Berkooz, D. Kutasov and N. Seiberg, *JHEP* **10**, 004 (1998) [hep-th/9808149]; O. Aharony, *Class. Quant. Grav.* **17**, 929 (2000) [hep-th/9911147]; D. Kutasov, Review prepared for ICTP Spring School on Superstrings and Related Matters,

- Trieste, Italy, 2-10 Apr 2001. Published in *Trieste 2001, Superstrings and related matters* 165-209.
- [11] D. Berenstein, J.M. Maldacena and H. Nastase, JHEP **0204**, 013 (2002) [hep-th/0202021].
 - [12] D. Kutasov and V. Sahakyan, JHEP **0102**, 021 (2001) [hep-th/0012258].
 - [13] L.A. Pando-Zayas and D. Vaman, Phys. Rev. D **67**, 106006 (2003) [hep-th/0208066]; B.R. Greene, K. Schalm and G. Shiu, Nucl. Phys. B **652**, 105 (2003) [hep-th/0208163]; R.C. Brower, D.A. Lowe and C-I. Tan, Nucl. Phys. B **652**, 127 (2003)[hep-th/0211201]; Y. Sugawara, Nucl. Phys. B **661**, 191 (2003) [hep-th/0301035]; G. Grignani, M. Orselli, G.W. Semenoff and D. Trancadelli, JHEP **0306**, 006 (2003) [hep-th/0301186].
 - [14] R. Brandenberger and C. Vafa, Nucl. Phys. B **316**, 391 (1989).
 - [15] R. Brandenberger, D. A. Easson and D. Kimberly, Nucl. Phys. B **623**, 421 (2002) [hep-th/0109165]; S. A. Abel, K. Freese and I. I. Kogan, JHEP **0101** 039 (2001) [hep-th/0005028].
 - [16] N. Deo, S. Jain and C.-I. Tan, Phys. Lett. B **220**, 125 (1989); Phys. Rev. D **40**, 2646 (1989); N. Deo, S. Jain, O. Narayan and C.-I. Tan, Phys. Rev. D **45**, 3641. (1992).
 - [17] D.A. Lowe and L. Thorlacius, Phys. Rev. D **51**, 665 (1995), [hep-th/9408134]; S. Lee and L. Thorlacius, Phys. Lett. B **413**, 303 (1997), [hep-th/9707167].
 - [18] T. Banks and E. Rabinovici, Nucl. Phys. B **160**, 349 (1979); D. Forster, Phys. Lett. B **77**, 211 (1978); M. Stone and P. Thomas, Phys. Rev. Lett. **41**, 351 (1978).
 - [19] I. Affleck and A.W.W. Ludwig, Phys. Rev. D **67**, 161 (1991); S. Elitzur, E. Rabinovici and G. Sarkisian, Nucl. Phys. B **541**, 246 (1999) [hep-th/9807161]; J.A. Harvey, D. Kutasov and E.J. Martinec, *On the relevance of tachyons*, hep-th/0003101.
 - [20] C. G. Callan, Jr and J. M. Maldacena, Nucl. Phys. B **513**, 198 (1998) [hep-th/9708147].
 - [21] M.B. Green Phys. Lett. B **266**, 325; (1991) Phys. Lett. B **329**, 435 (1994) [hep-th/9403040]; M.A. Vázquez-Mozo, Phys. Lett. B **388**, 494, (1996) [hep-th/9607052].
 - [22] J.L.F. Barbón, I.I. Kogan and E. Rabinovici, Nucl. Phys. B **544**, 104 (1999) [hep-th/9809033].
 - [23] J. Atick and E. Witten, Nucl. Phys. B **310**, 291 (1988).
 - [24] D.J. Gross, M.J. Perry and L.G. Yaffe, Phys. Rev. D **25**, 330 (1982).
 - [25] G.T. Horowitz and J. Polchinski, Phys. Rev. D **55**, 6189 (1997) [hep-th/9612146].
 - [26] O. Aharony, S. S. Gubser, J. M. Maldacena, H. Ooguri and Y. Oz, Phys. Rept. **323**, 183 (2000) [hep-th/9905111.]
 - [27] J.M. Maldacena, Adv. Theor. Math. Phys. **2**, 231 (1998) [hep-th/9711200]; S.S. Gubser, I.R. Klebanov and A.M. Polyakov, Phys. Lett. B **428**, 105 (1998) [hep-th/9802109]; E. Witten, Adv. Theor. Math. Phys. **2**, 253 (1998) [hep-th/9802150].

- [28] G. Veneziano, *Europhys. Lett.* **2**, 199 (1986); G. Veneziano, in *Hagedorn Festschrift*. Eds: Jean Letessier, Hans Gutbrod and Johann Rafelski, NATO-ASI Series B: Physics **346**, 63 (Plenum Press, New York, 1995); L. Susskind, *Some Speculations About Black Hole Entropy In String Theory*, hep-th/9309145.
- [29] G.T. Horowitz and J. Polchinski, *Phys. Rev. D* **57**, 2557 (1998) [hep-th/9707170]; T. Damour and G. Veneziano, *Nucl. Phys. B* **568**, 93 (2000) [hep-th/9907030].
- [30] E. Witten, *Nucl. Phys. B* **195**, 650; (1982) S.P. de Alwis and A.T. Flournoy, *Phys. Rev. D* **66**, 026005 (2002) [hep-th/0201185]; O. Aharony, M. Fabinger, G.T. Horowitz and E. Silverstein, *JHEP* **0207**, 007 (2002) [hep-th/0204158].
- [31] J.L.F. Barbón and E. Rabinovici, *Found. Phys.* **33**, 145 (2003) [hep-th/0211212.]
- [32] A. Adams, J. Polchinski and E. Silverstein, *JHEP* **0110**, 029 (2001) [hep-th/0108075]; J.A. Harvey, D. Kutasov, E.J. Martinec and G. Moore, *Localized tachyons and RG flows*, hep-th/0111154.
- [33] I. Antoniadis and C. Kounnas, *Phys. Lett. B* **261**, 369 (1991); I. Antoniadis, J.P. Derendinger and C. Kounnas, *Nucl. Phys. B* **551**, 41 (1999) [hep-th/9902032]; I. Bakas, A. Bilal, J.P. Derendinger and K. Sfetsos, *Nucl. Phys. B* **593**, 31 (2001) [hep-th/0006222].
- [34] B. Sundborg, *Nucl. Phys. B* **573**, 349 (2000) [hep-th/9908001]; O. Aharony, J. Marsano, S. Minwalla, K. Papadodimas and M. Van Raamsdonk, *The Hagedorn / deconfinement phase transition in weakly coupled large N gauge theories*, hep-th/0310285.
- [35] R. Rohm, *Nucl. Phys. B* **237**, 553 (1984); E. Alvarez and M.A.R. Osorio, *Phys. Rev. D* **40**, 1150 (1989); O. Bergman and M.R. Gaberdiel, *JHEP* **07**, 022 (1999) [hep-th/9906055].
- [36] B. McClain and B. Roth, *Commun. Math. Phys.* **111**, 539 (1987); E. Alvarez and M.A.R. Osorio, *Nucl. Phys. B* **304**, 327 (1988).
- [37] M. Headrick, S. Minwalla and T. Takayanagi, *Class. Quant. Grav.* **21**, S1539 (2004) [hep-th/0405064].
- [38] A. Sen, *Non-BPS states and branes in string theory*, hep-th/9904207; *JHEP* **9808**, 012 (1998) [hep-th/9805170].
- [39] J. Polchinski, *Commun. Math. Phys.* **104**, 37 (1986).
- [40] M.A.R. Osorio and M.A. Vázquez-Mozo, *Phys. Lett. B* **280**, 21 (1992) [hep-th/9201044]; *Phys. Rev. D* **47**, 3411 (1993) [hep-th/9207002].
- [41] M. Li, E. Martinec and V. Sahakyan, *Phys. Rev. D* **59**, 044035 (1999) [hep-th/9809061]; E. Martinec and V. Sahakyan, *Phys. Rev. D* **59**, 124005 (1999) [hep-th/9810224]; *ibid* **60**, 064002 (1999) [hep-th/9901135].
- [42] O. Aharony, J. Marsano, S. Minwalla and T. Wiseman, *Black hole - black string phase transitions in thermal 1+1 dimensional supersymmetric Yang-Mills theory on a circle*, hep-th/0406210.

- [43] J. R. David, M. Gutperle, M. Headrick and S. Minwalla, JHEP **0202**, 041 (2002) [hep-th/0111212].
- [44] S.W. Hawking and D. Page, Commun. Math. Phys. **87**, 577 (1983).
- [45] E. Witten, Adv. Theor. Math. Phys. **2**, 505 (1998) [hep-th/9803131]; T. Banks, M.R. Douglas, G.T. Horowitz and E. Martinec, *AdS dynamics from conformal field theory*, hep-th/9808016; J.L.F. Barbón and E. Rabinovici, Nucl. Phys. B **545**, 371 (1999) [hep-th/9805143].
- [46] R. Gregory and R. Laflamme, Phys. Rev. Lett. **70**, 2837 (1993) [hep-th/9301052]; Nucl. Phys. B **428**, 399 (1994) [hep-th/9404071]; Phys. Rev. D **51**, 305 (1995) [hep-th/9410050].
- [47] J.L.F. Barbón and E. Rabinovici, JHEP **0203**, 057 (2002) [hep-th/0112173].
- [48] J.L.F. Barbón and C. Hoyos, JHEP **0401**, 049 (2004) [hep-th/0311274].